



Main features

- Pt100 sensor element, 2- or 4-wire
- Built in graphical display, *CombiView™* DFON optional
- Head mounted 4...20 mA transmitter, FlexTop type 22xx
- HART®, PA
- ATEX
- EHEDG (pending)
- 3A, FDA
- Programmable by touch screen
- Easy and full programmable with FlexProgrammer 9701

Applications

- Food and beverage
- Pharmaceutical
- Water treatment
- General process industry



Main characteristics (20 °C)

Standard process temperature	-50 ... 250 °C
Accuracy	Pt100 output as to DIN/EN/IEC 60751 Transmitter output $\lt; \pm 0.1 \text{ °C} / \lt; \pm 0,25 \text{ °C}$
Connections	Hygienic

Technical specification

Measuring principle	Resistance Temperature Detector (RTD)
Measuring ranges	-50...250 °C
Immersion tube, diameter	Ø6 mm, Ø8 mm
Immersion tube, length	Min. 20 mm - Max. 3000 mm
Immersion tube, tip	Normal response - Ø6/Ø8 mm Fast response - Ø6/Ø4 or Ø8/Ø4 mm
Process connections	See page 4

Environment

Temperature, Ambient	-40...160 °C
- w. transmitter	-40...85 °C
- w. display	-30...80 °C
Protection rating, IEC 529	IP67 / IP69K, depending on electrical connection With BattTemp : IP54
Humidity, IEC 68-2-38	98%, condensing
Vibration IEC60068-2-6	DNV high vibration strain, class B 1.6 mm, 2...25 Hz IEC60068-2-6, test FC 25...100 Hz, 4.0 g

Material

Process connection	S.S. 14404, AISI 316L
Housing	S.S. 14301, AISI 304
Sealing	To be ordered separately see table page 4

Approvals

Apply to	EMC directive 2004/108/CE in accordance with EN 61000-6-2, EN 61000-6-3 Pressure directive 97/23/CE FDA
Certificates	3A EHEDG (pending)

Sensor element and electrical specification

Sensor type	RTD type Pt100 (acc. to DIN/EN/IEC 60751) Single or Double 2-wire or 4-wire
Accuracy	Class 1/1 B $\pm(0,3 + (0,005 \times T)) \text{ °C}$ Class 1/3 B $\pm 1/3 \times (0,3 + (0,005 \times T)) \text{ °C}$ Class 1/6 B $\pm 1/6 \times (0,3 + (0,005 \times T)) \text{ °C}$ Class 1/1 A $\pm(0,15 + (0,002 \times T)) \text{ °C}$
Analog output	4-20 mA, 4-20mA+HART®, Profibus® See separate data sheet, series 22xx

Time constant, τ 0,5

Medium	Liquid	Air	Air
Velocity	0,4 m/sec.	0 m/sec	3 m/sec
Ø 6mm	$\lt; 6,1$	$\lt; 138$	$\lt; 27,2$
Ø 6/4mm	$\lt; 1,5$	$\lt; 136$	$\lt; 21,4$
Ø 8mm	$\lt; 7,6$	$\lt; 201$	$\lt; 47,7$
Ø 8/4mm	$\lt; 1,5$	$\lt; 181$	$\lt; 33,6$

Temperature curve

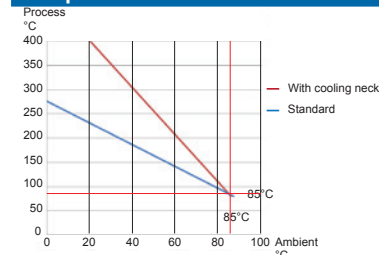

Technical Data

Transmitter, type FlexTop 2202 - Standard

Input	Pt100
Output	4...20 mA
Accuracy	
Input	<0.25°C
Output	<0.1% signal span (16mA)
Range	-200...850°C
Minimum span	25°C
Supply	8...35 VDC
Programmability	By FlexProgrammer 9701
For further information please see data sheet for FlexTop 2202	

Transmitter, type FlexTop 2211 - Performance

Input	Pt100 / Pt1000 (universal)
Output	4...20 mA
Accuracy	
Input	<0.1°C
Output	<0.1% signal span (16mA)
Range	-200...850°C
Minimum span	25°C
Supply	8...35 VDC
Programmability	By FlexProgrammer 9701
For further information please see data sheet for FlexTop 2211	

Display DFON

Type	Graphically LCD
Front glass	Polycarbonate
Display modes	8 modes, programmable, e.g. value, bar graph, analogue, tank illustration
Background	White, green, red - programmable
Measuring range	-9999...99999
Digit height	Max. 22 mm
Accuracy	0,1% @ ambient -10...70 °C
Voltage drop	4V...6.5 V
Output	2 configurable relay output, 60 Vp, 75 mA
Programming	Touch screen or FlexProgrammer 9701

Further information can be found in separate data sheet for DFON, D21.09.

Transmitter, type FlexTop 2221 - Performance, HART®

Input	Pt100 / Pt1000 (universal)
Output	4...20 mA / HART
Accuracy	
Input	<0.1°C
Output	<0.1% signal span (16mA)
Range	-200...850°C
Minimum span	25°C
Supply	8...35 VDC
Programmability	By FlexProgrammer 9701 By HART terminal/modem
For further information please see data sheet for FlexTop 2221	

Transmitter, type FlexTop 2231 - Performance, Profibus®

Input	Pt100 / Pt1000 (universal)
Output	Profibus PA
Accuracy	
Input	<0.1°C
Range	-200...850°C
Minimum span	25°C
Supply	9...32 VDC
Programmability	By FlexProgrammer 9701
For further information please see data sheet for FlexTop 2231	

BattTemp

Type	LCD
Front glass	Polycarbonate
Temperature sensor	Pt-100, 2-wire (DIN/EN/IEC 60751)
Power supply	Battery 1,5 V, type AA
Range	-200...850°C
Measuring range	-9999...9999
Unit	°C
Digit height	11,5 mm.
Accuracy	
-200...-51°C	+/- 0,6 +/- 1 digit
-50...300°C	+/- 0,3 +/- 1 digit
301...850°C	+/- 0,6 +/- 1 digit
For further information please see datasheet for BattTemp	

Electrical connections

M12, 5-wire

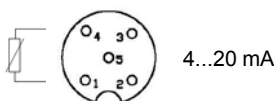

RTD Single	Double	1	- supply, 4...20 mA
1+2	Pt100-1	2	Common for relays
3+4	Pt100-1	3	+ supply, 4...20 mA
1	Pt100 - 1	4	Relay 1
2	Pt100 - 1	5	Relay 2
3	Pt100 - 2		
4	Pt100 - 2		
5	N.C.		

M12, 8-wire

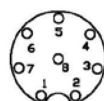

1	N.C.
2	- supply, 4...20 mA
3	Relay 1
4	Relay 1
5	Relay 2
6	Relay 2
7	+ supply, 4...20 mA
8	N.C.

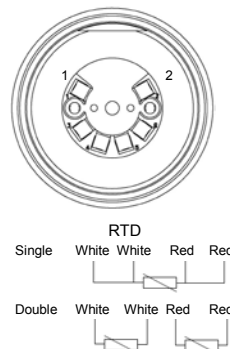

Cable gland

Transmitter	
1	+24VDC / - 4...20mA
2	- 24VDC / +4...20mA
1	Red clip (FlexProgrammer)
2	Black clip (FlexProgrammer)

Display

1	N.C.
2	N.C.
3	Relay 1
4	Relay 1
5	Relay 2
6	Relay 2
Com 1	Red clip (FlexProgrammer)
Com 2	Black clip (FlexProgrammer)

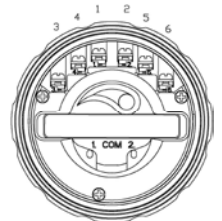



ATEX data for temperature transmitters and displays
Transmitter, type FlexTop 2202 - ATEX

Approval	Ex ia IIC T5/T6, ATEX II 1G Ex nA II T5, ATEX II 3G
Supply	8...28 VDC
Internal inductivity	$L_i \leq 10 \mu\text{H}$
Internal capacity	$C_i \leq 10 \text{nF}$
Temperature class	T1...T5: $-40 < T_{\text{amb}} < 85^\circ\text{C}$ T6: $-40 < T_{\text{amb}} < 50^\circ\text{C}$
Barrier data	U: $\leq 28 \text{VDC}$ I: $\leq 0.1 \text{A}$ P: $\leq 0.75 \text{W}$

Transmitter, type FlexTop 2211 - ATEX

Approval	Ex ia IIC T5/T6, ATEX II 1G Ex nA II T5, ATEX II 3G
Supply	6.5...30 VDC
Internal inductivity	$L_i \leq 15 \mu\text{H}$
Internal capacity	$C_i \leq 5 \text{nF}$
Temperature class	T1...T5: $-40 < T_{\text{amb}} < 85^\circ\text{C}$ T6: $-40 < T_{\text{amb}} < 50^\circ\text{C}$
Barrier data	U: $\leq 30 \text{VDC}$ I: $\leq 0.1 \text{A}$ P: $\leq 0.75 \text{W}$

Display DFON - ATEX
ATEX Gas ia and for ATEX Dust ia

Approval	Gas Zone 0/1 Dust Zone 20/21	 II 1 G, Ex ia IIC T5 Ga  II 1 D, Ex ia IIIC T100°C Da
Voltage drop	U_{Disp}	4.5 ... 6.5 VDC
Temperature class	$L_i \leq 15 \mu\text{H}$ $C_i \leq 5 \text{nF}$	
Temperature class	T1...T5	Zone 0 and 20 $-20 \dots 60^\circ\text{C}$ Zone 1/2 and 21/22 $-40 \dots 65^\circ\text{C}$
Internal inductivity	L_i	$< 10 \mu\text{H}$
Internal capacity	C_i	$< 15 \text{nF}$
Barrier data	U_i I_i P_i	$< 30 \text{VDC}$ $< 0.1 \text{A}$ $< 0.75 \text{W}$

ATEX Gas nA

Approval	Gas Zone 2	 II 3 G, Ex nA II T5
Voltage drop	U_{Disp}	4.5 ... 6.5 VDC
Temperature class	T1...T5	$-30 < T_{\text{amb}} < 65^\circ\text{C}$
Internal inductivity	L_i	$< 10 \mu\text{H}$
Internal capacity	C_i	$< 15 \text{nF}$
Maximum voltage	U_{max}	$< 35 \text{VDC}$
Maximum current	U_{max}	$< 0.1 \text{A}$

Transmitter, type FlexTop 2221 - ATEX

Approval	Ex ia IIC T5/T6, ATEX II 1G Ex nA II T5, ATEX II 3G
Supply	8...30 VDC (Ex nA: 12...30 VDC)
Internal inductivity	$L_i \leq 15 \mu\text{H}$
Internal capacity	$C_i \leq 5 \text{nF}$
Temperature class	T1...T5: $-40 < T_{\text{amb}} < 85^\circ\text{C}$ T6: $-40 < T_{\text{amb}} < 50^\circ\text{C}$
Barrier data	U: $\leq 30 \text{VDC}$ I: $\leq 0.1 \text{A}$ P: $\leq 0.75 \text{W}$

Transmitter, type FlexTop 2231 - ATEX

Approval	Ex ia IIC T5/T6, ATEX II 1G Ex nA II T5, ATEX II 3G	
Internal inductivity	$L_i \leq 10 \mu\text{H}$	
Internal capacity	$C_i \leq 2 \text{nF}$	
Temperature class	T1...T4: $-40 < T_{\text{amb}} < 85^\circ\text{C}$ T5: $-40 < T_{\text{amb}} < 60^\circ\text{C}$	
Coupler/link FISCO approved	$U_i \leq 17.5 \text{VDC}$ $P_i \leq 0.75 \text{W}$ $L_i \leq 10 \mu\text{H}$	$I_i \leq 0.275 \text{A}$ $C_i \leq 2 \text{nF}$
Barrier data	$U_i \leq 20 \text{VDC}$ $P_i \leq 0.75 \text{W}$ $L_i \leq 10 \mu\text{H}$	$I_i \leq 0.1 \text{A}$ $C_i \leq 2 \text{nF}$

ATEX data for BattTemp

Approval	Ex ia IIC T5/T6, ATEX II 1G
Temperature class	
Battery: Energizer Lithium FR6 L91 AA	T1...T4: $-10 < T_{\text{amb}} < 70^\circ\text{C}$ T5: $-10 < T_{\text{amb}} < 50^\circ\text{C}$
Battery: Duracell Alkaline MN1500 LR6 AA	T1...T3: $-10 < T_{\text{amb}} < 70^\circ\text{C}$ T4: $-10 < T_{\text{amb}} < 60^\circ\text{C}$

Dimensions (mm)

Ø80 mm housing front view

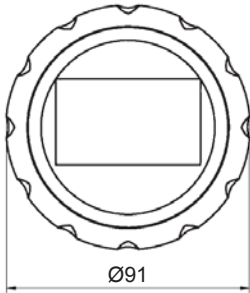

Ø80 mm housing bottom connection

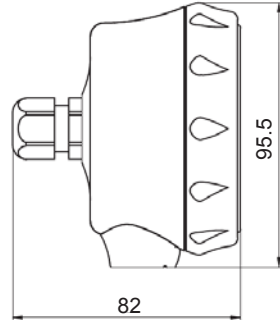

Ø80 mm housing rear connection

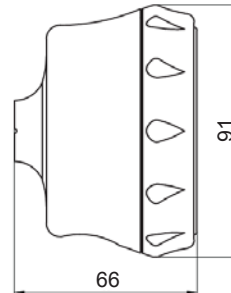

Ø55 mm housing

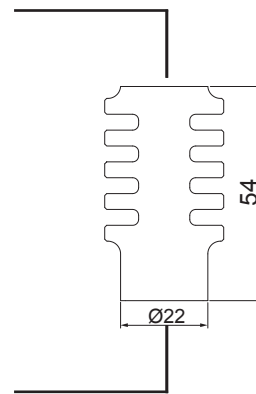
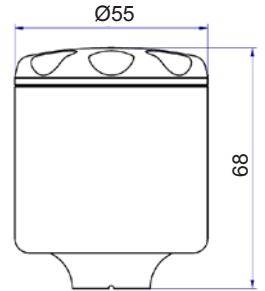

G1/2A Hygiene
Code 51

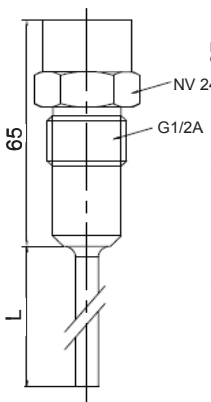

3A DN 38
Code 60

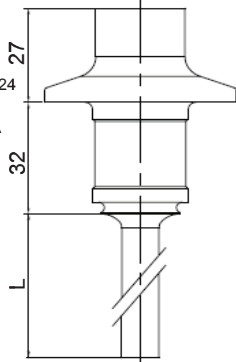

ISO 2852 DN 38
Code 65

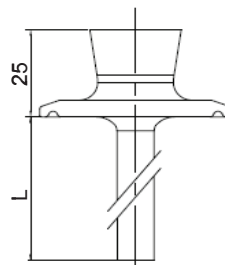

ISO 2852 DN 51
Code 66

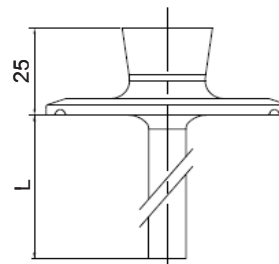

Variline® type N
Code 70

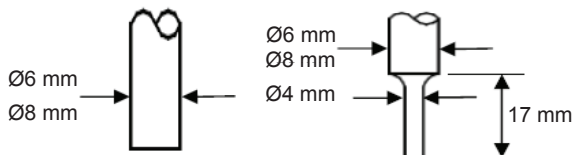
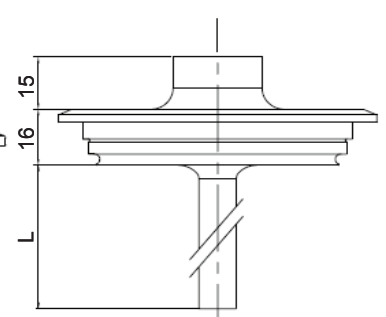

Seal is to be purchased separately.
For other types and materials please see data sheet for accessories.

Accessories – seals

Seal type	Code	Material	Approvals	Item Number
O-ring	60	EPDM	3A FDA	8126982
-	70	EPDM	3A FDA	8126979
Gasket	65	EPDM	3A FDA	8126980
-	66	EPDM	3A FDA	8126981

