



# Mufflers

## Quietaire® Series

### Compressed Air Mufflers

|  |                 |
|--|-----------------|
| <b>Features and Benefits</b> .....                           | <b>FIT-8-2</b>  |
| <b>Muffler Shape Codes</b> .....                             | <b>FIT-8-3</b>  |
| <b>Shell Type Quietaire® Mufflers</b> .....                  | <b>FIT-8-4</b>  |
| <b>Nadir Air Exhaust Silencer</b> .....                      | <b>FIT-8-5</b>  |
| <b>Sintered Type Quietaire® Mufflers</b> .....               | <b>FIT-8-6</b>  |
| <b>Porous Plastic Type Quietaire Mufflers</b> .....          | <b>FIT-8-7</b>  |
| <b>Quietaire® Coalescing Mufflers</b> .....                  | <b>FIT-8-8</b>  |
| <b>High Performance Coalescing Quietaire® Mufflers</b> ..... | <b>FIT-8-9</b>  |
| <b>Quietaire® Speed Control Mufflers</b> .....               | <b>FIT-8-10</b> |
| <b>Quietaire® Breather Vents</b> .....                       | <b>FIT-8-13</b> |
| <b>Quietaire® Small Part Ejectors</b> .....                  | <b>FIT-8-14</b> |

- Mufflers prevent metal chips, abrasive grits, dust and other contaminants from entering open exhaust ports and causing premature valve failure.
- Coalescing Mufflers help prevent oil mist and solid particles from contaminating factory air.
- Speed Control Mufflers allow the adjustment of exhaust flow to accurately control cylinder speed.
- Parts Ejectors use less air than open lines with only minor reduction of thrust.
- Breather vents prevent damage caused when dirt, chips and other foreign particles enter vacuum relief ports or breather tubes.



### OSHA Permissible Noise Exposures\*

Compressed air exhausts generate high intensity sound energy, much of it in the same frequency range as normal conversation. Prolonged exposure to noise causes hearing impairment without noticeable pain or discomfort. See Table below for permissible noise exposures and graphs on the following pages for the sound suppression characteristics of Quietaire products.

| Daily Duration (Hours) | Sound Level (dBa) |
|------------------------|-------------------|
| 8                      | 90                |
| 6                      | 92                |
| 4                      | 95                |
| 3                      | 97                |
| 2                      | 100               |
| 1-1/2                  | 102               |
| 1                      | 105               |
| 1/2                    | 110               |
| 1/4                    | 115               |

\*OSHA Safety and Health Standards (29 CFR 1910.95)

### Increase Productivity

Continual noise causes worker fatigue, resulting in reduced productivity and a reduction in profits. Noise abatement helps prevent noise fatigue, one of the main causes of industrial inefficiency and accidents.

### Cleaner Work Environment

Open exhaust ports on compressed air devices can release oil vapors, oil aerosols, and particulates into the atmosphere. Quietaire coalescing mufflers remove these contaminants from the exhaust air and also reduce noise to permissible levels.

### Prolong Service Life

Open exhaust ports invite the entry of contaminants - metal chips, abrasive grits, sweepings (floor mounted units) and other debris. Quietaire mufflers prevent the entry of such contaminants, prolonging the service life of your air valves, air motors and similar equipment.

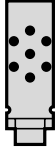

**Shell Type Quietaire Heavy Duty Mufflers**  
(MA and MB Series) p. FIT-8-4.

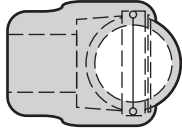

**Nadir Air Exhaust Silencer**  
(MF and MFT Series) p. FIT-8-5.

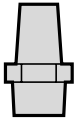

**Sintered Type Quietaire Mufflers**  
(MS and T40 Series) p. FIT-8-6.



**Porous Plastic Type Quietaire Mufflers**  
(C/S, M/S, and MU Series) p. FIT-8-7.

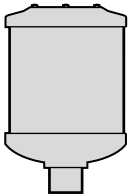

**Coalescing Quietaire Mufflers**  
(MC Series) p. FIT-8-8.

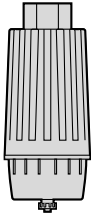

**High Performance Quietaire Coalescing Muffler**  
(MQ Series) p. FIT-8-9.

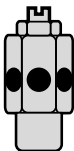

**Quietaire Speed Control Mufflers**  
(MM and T20 Series) p. FIT-8-10.



**Quietaire Breather Vents**  
(MV and M/1510 Series) p. FIT-8-13.



**Quietaire Small Parts Ejectors**  
(ME Series) p. FIT-8-14.



# Shell Type Quietaire Mufflers

Dimensions in Inches (mm)

- Superior sound attenuation
- High flow capacity
- Low back pressure
- Corrosion resistant construction
- Brass mesh screen and aluminum construction provide improved flow, longer life, and a cleanable element.
- 60 x 50 mesh – .007 wire diameter (several layers)

Male Thread

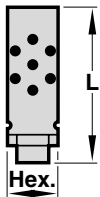

| Port Size<br>NPT | NPT<br>(std)  | ISO R<br>(opt) | Flow Factor<br>Cv + -10% | Dimensions   |              |
|------------------|---------------|----------------|--------------------------|--------------|--------------|
|                  |               |                |                          | Hex.         | L            |
| 1/8              | <b>MB001A</b> | MB001B         | 2                        | 13/16 (20.6) | 2.00 (50.9)  |
| 1/4              | <b>MB002A</b> | MB002B         | 2.7                      | 13/16 (20.6) | 2.17 (55.2)  |
| 3/8              | <b>MBP03A</b> | MBP03B         | 3.2                      | 13/16 (20.6) | 2.17 (55.2)  |
| 3/8              | <b>MB003A</b> | MB003B         | 4.9                      | 1-1/4 (31.8) | 3.47 (88.1)  |
| 1/2              | <b>MB004A</b> | MB004B         | 5.9                      | 1-1/4 (31.8) | 3.62 (91.9)  |
| 3/4              | <b>MBP06A</b> | MBP06B         | 5.9                      | 1-1/4 (31.8) | 3.64 (92.4)  |
| 3/4              | <b>MB006A</b> | MB006B         | 13.5                     | 2 (50.8)     | 5.28 (134.0) |
| 1                | <b>MB008A</b> | MB008B         | 16.7                     | 2 (50.8)     | 5.43 (138.0) |
| 1-1/4            | <b>MBP10A</b> | MBP10B         | 17.4                     | 2 (50.8)     | 5.51 (140.0) |

Female Thread

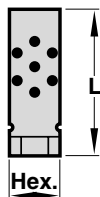

| Port Size<br>NPT | NPT<br>(std)  | ISO R<br>(opt) | Flow Factor<br>Cv + -10% | Dimensions   |              |
|------------------|---------------|----------------|--------------------------|--------------|--------------|
|                  |               |                |                          | Hex.         | L            |
| 1/8              | <b>MA001A</b> | MA001B         | 0.8                      | 13/16 (20.6) | 1.67 (42.4)  |
| 1/4              | <b>MA002A</b> | MA002B         | 2.4                      | 13/16 (20.6) | 1.78 (45.2)  |
| 3/8              | <b>MA003A</b> | MA003B         | 5.7                      | 1-1/4 (31.8) | 3.08 (78.3)  |
| 1/2              | <b>MA004A</b> | MA004B         | 6.9                      | 1-1/4 (31.8) | 3.29 (83.5)  |
| 3/4              | <b>MA006A</b> | MA006B         | 18.0                     | 2 (50.8)     | 4.65 (118.0) |
| 1                | <b>MA008A</b> | MA008B         | 20.0                     | 2 (50.8)     | 4.65 (118.0) |
| 1-1/4            | <b>MA010A</b> | MA010C         | 42.0                     | 2-1/2 (63.5) | 5.67 (144.0) |
| 1-1/2            | <b>MA012A</b> | MA012C         | 39.0                     | 2-1/2 (63.5) | 5.67 (144.0) |
| 2                | <b>MA016A</b> | MA016C         | 59.0                     | 3 (76.2)     | 6.61 (168.0) |
| 2-1/2            | <b>MA020A</b> | MA020C         | –                        | 4 (102)      | 7.13 (181)   |

## Technical Data

Maximum Pressure: 300 psig (20.7 bar)

Maximum temperature: 176°F (80°C)

## Materials

Element: Brass wire

Base: Aluminum

Shell: Aluminum

## Graphic Symbol





- Meets all OSHA standards
- Machined from high tensile aluminum with no plastics or castings
- Will pass particle contaminants to 100 microns
- Easily cleaned for longer service life
- Can withstand temperatures of 1000 degrees F

**Technical Data**

Maximum Pressure: 150 psi (10 bar)  
 Maximum temperature: 1000°F (538°C)

**Materials**

Aluminum and Sintered Bronze

**Graphic Symbol**

| Model   | A<br>Barrell | B<br>Overall | C<br>Dia | D<br>Thread | E<br>Flats |
|---------|--------------|--------------|----------|-------------|------------|
| MF-14   | 1-15/32      | 1-15/16      | 1-1/4    | 1/4 NPT     | 1-5/32     |
| MFT-38  | 1-15/32      | 1-15/16      | 1-1/4    | 3/8 NPT     | 1-5/32     |
| MF-38   | 1-3/4        | 2-5/16       | 1-1/2    | 3/8 NPT     | 1-1/4      |
| MFT-12  | 1-3/4        | 2-5/16       | 1-1/2    | 1/2 NPT     | 1-1/4      |
| MF-12   | 1-7/8        | 2-5/8        | 1-3/4    | 1/2 NPT     | 1-1/2      |
| MFT-34  | 1-7/8        | 2-5/8        | 1-3/4    | 3/4 NPT     | 1-1/2      |
| MF-34   | 3-5/16       | 4-7/8        | 2-3/8    | 3/4 NPT     |            |
| MFT-1   | 3-5/16       | 4-7/8        | 2-3/8    | 1 NPT       |            |
| MF-100  | 4-3/8        | 6-1/2        | 3        | 1 NPT       |            |
| MFT-114 | 4-3/8        | 6-1/2        | 3        | 1-1/4 NPT   |            |
| MF-114  | 5-9/16       | 8-11/32      | 4        | 1-1/4 NPT   |            |
| MFT-112 | 5-9/16       | 8-11/32      | 4        | 1-1/2 NPT   |            |
| MF-112  | 6-1/2        | 9-7/8        | 4-1/2    | 1-1/2 NPT   |            |
| MFT-200 | 6-1/2        | 9-7/8        | 4-1/2    | 2 NPT       |            |

**Dimensional Data**

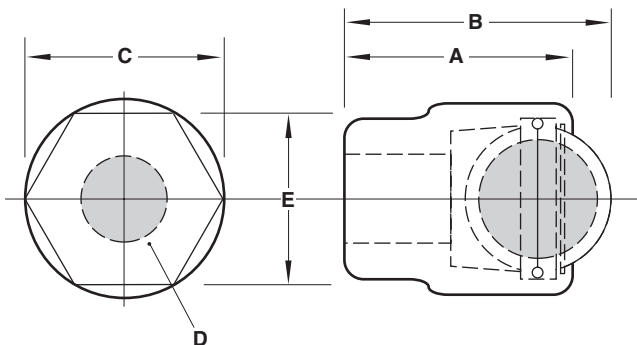

**Dimensional Data**

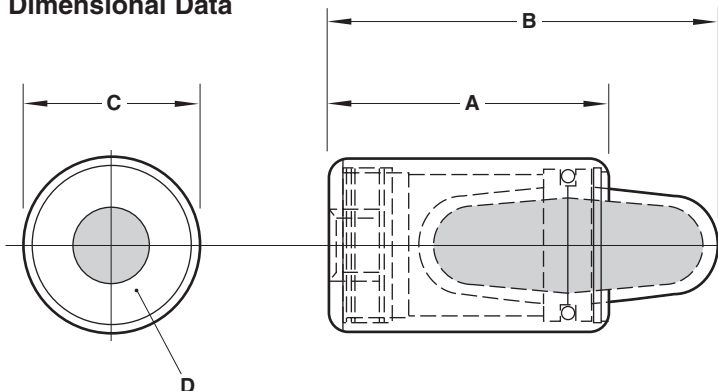



# Sintered Type Quietaire Mufflers

Dimensions in Inches (mm)

- Reduces noise levels of pneumatic equipment
- Cleanable 40-micron diffuser elements
- Compact design
- Corrosion resistant construction
- Prevents dirt ingress

## Male Thread

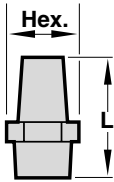

| Port Size<br>NPT | Part Number | Flow Factor<br>Cv | Dimensions |           |
|------------------|-------------|-------------------|------------|-----------|
|                  |             |                   | Hex.       | L         |
| 10-32            | MS000A      | —                 | 5/16       | 0.70 (18) |
| 1/8              | MS001A      | 0.7               | 7/16       | 1.13 (29) |
| 1/4              | MS002A      | 1.4               | 9/16       | 1.38 (35) |
| 3/8              | MS003A      | 1.9               | 11/16      | 1.50 (38) |
| 1/2              | MS004A      | 3.8               | 7/8        | 1.88 (48) |
| 3/4              | MS006A      | 6.5               | 1-1/16     | 2.25 (57) |
| 1                | MS008A      | 10.5              | 1-5/16     | 2.88 (73) |
| 1-1/4            | MS010A      | 11.8              | 1-11/16    | 3.25 (83) |
| 1-1/2            | MS012A      | 18.3              | 2          | 3.69 (94) |

| Port Size<br>ISO G | Part Number | Flow Factor<br>Cv | Dimensions |           |
|--------------------|-------------|-------------------|------------|-----------|
|                    |             |                   | Hex.       | L         |
| M5                 | T40M0500    | 0.2               | 7          | 0.79 (20) |
| 1/8                | T40C1800    | 0.54              | 13         | 0.94 (24) |
| 1/4                | T40C2800    | 1.6               | 17         | 1.30 (33) |
| 3/8                | T40C3800    | 3.5               | 22         | 1.73 (44) |
| 1/2                | T40C4800    | 5.1               | 27         | 2.20 (56) |
| 3/4                | T40C6800    | 9.0               | 32         | 3.15 (80) |
| 1                  | T40C8800    | 11.6              | 41         | 3.23 (82) |

## Technical Data

Maximum Pressure: NPT - 300 psig (20.7 bar)  
 ISO - 150 psig (10 bar)  
 Maximum temperature: NPT - 300°F (149°C)  
 ISO - 175°F (80°C)

## Materials

Element: Sintered bronze  
 Base: Nickel plated steel (NPT), Brass (ISO)

## Graphic Symbol



| Port Size<br>ISO R | Part Number | Flow Factor<br>Cv | Dimensions |             |
|--------------------|-------------|-------------------|------------|-------------|
|                    |             |                   | Hex.       | L           |
| 1/8                | T40B1800    | 0.54              | 13         | 1.08 (27.5) |
| 1/4                | T40B2800    | 1.6               | 17         | 1.42 (36)   |
| 3/8                | T40B3800    | 3.5               | 22         | 1.83 (46.5) |
| 1/2                | T40B4800    | 5.1               | 27         | 2.36 (60)   |
| 3/4                | T40B6800    | 9.0               | 32         | 3.35 (85)   |
| 1                  | T40B8800    | 11.6              | 41         | 1.61 (41)   |

## Performance Characteristics

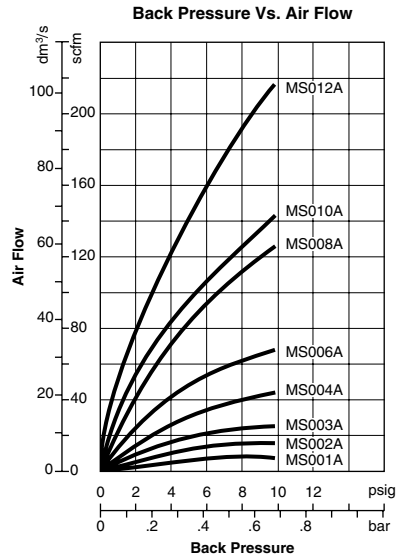
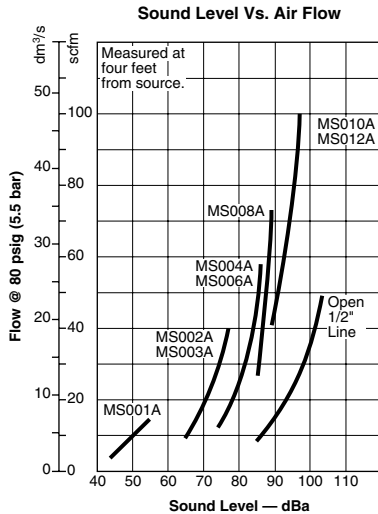

# Porous Plastic Type Quietaire Mufflers

Dimensions in Inches (mm)



- Compact and light weight
- Low cost alternative to metal designs
- Threads directly into the exhaust port
- Prevents contamination from dirt
- 75 Micron

## Technical Data

Maximum Pressure: Vacuum to 150 psig (10 bar)  
 Maximum Temperature: 125°F (51.7°C) (MU Series)  
 Temperature Range: -0° to 175°F (-20° to 80°C) (C/S and M/S series)  
 Materials (C/S and M/S series): UHMW Polyethylene porous plastic body and polyethylene base

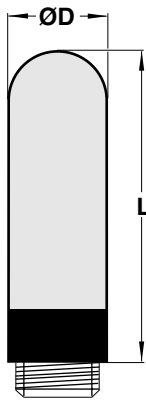

| Port Size | Part Number |                 | Dimensions   |             | Weight oz. (g) |
|-----------|-------------|-----------------|--------------|-------------|----------------|
|           | NPT         | Metric or ISO G | L (mm)       | D (mm)      |                |
| M5        | -           | M/S0*           | 0.75 (18.9)  | 0.26 (6.5)  | 0.01 (.35)     |
| 1/8       | C/S1        | M/S1            | 1.12 (28.3)  | 0.50 (12.5) | 0.06 (1.3)     |
| 1/4       | C/S2        | M/S2            | 1.40 (35.5)  | 0.62 (15.5) | 0.10 (2.9)     |
| 3/8       | C/S3        | M/S3            | 2.20 (56.0)  | 0.73 (18.5) | 0.26 (6.7)     |
| 1/2       | C/S4        | M/S4            | 2.65 (67.0)  | 0.91 (23.0) | 0.41 (11.5)    |
| 3/4       | C/S6        | M/S6            | 4.88 (123.5) | 1.50 (38.0) | 1.41 (40.0)    |
| 1         | C/S8        | M/S8            | 5.54 (140.5) | 2.00 (49.0) | 2.12 (60.0)    |

\* Due to the pliable nature of the thermoplastic base material this may be installed in 10-32 UNF ports. (Formerly part number M/1545.)

| Port Size | Part Number |       | Flow Factor Cv** | ΔContinuous Sound Pressure Level (dBA) |                 |
|-----------|-------------|-------|------------------|--|-----------------|
|           | NPT         | ISO G |                  | 10 psig (0.7 bar)                      | 90 psig (6 bar) |
| M5        |             | M/S0  | 0.31             | 59                                     | 82.7            |
| 1/8       | C/S1        | M/S1  | 1.0              | 67                                     | 84              |
| 1/4       | C/S2        | M/S2  | 1.84             | 58                                     | 84              |
| 3/8       | C/S3        | M/S3  | 4.0              | 65                                     | 81              |
| 1/2       | C/S4        | M/S4  | 5.3              | 59                                     | 82              |
| 3/4       | C/S6        | M/S6  | 8.0              | 71                                     | 98              |
| 1         | C/S8        | M/S8  | 12.2             | 70                                     | 94              |

\*\*Cv measured in US gal/min  
 Δ SPL at 3.28 ft. (1m) from unit

## T45 Series

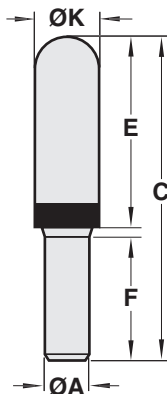

| A Port Size | Part Number | C           | E           | F           | ØK          | Weight oz (g) |
|-------------|-------------|-------------|-------------|-------------|-------------|---------------|
| 5/32"       | T45Y0002    | 1.30 (33.0) | 0.67 (17.0) | 0.59 (15.0) | 0.26 (6.5)  | 0.04 (1.0)    |
| 1/4"        | T45Y0004    | 1.77 (45.0) | 0.98 (25.0) | 0.67 (17.0) | 0.49 (12.5) | 0.05 (1.5)    |
| 3/8"        | T45Y0006    | 2.26 (57.5) | 1.22 (31.0) | 0.91 (23.0) | 0.61 (15.5) | 0.12 (3.5)    |
| 6mm         | T45P0006    | 1.77 (45.0) | 0.98 (25.0) | 0.67 (17.0) | 0.49 (12.5) | 0.05 (1.5)    |
| 8mm         | T45P0008    | 1.71 (43.5) | 0.87 (22.0) | 0.75 (19.0) | 0.53 (13.5) | 0.07 (2.0)    |
| 10mm        | T45P0010    | 2.26 (57.5) | 1.22 (31.0) | 0.91 (23.0) | 0.61 (15.5) | 0.12 (3.5)    |
| 12mm        | T45P0012    | 3.21 (81.5) | 2.11 (53.5) | 1.04 (26.5) | 0.73 (18.5) | 0.25 (7.0)    |



# Quietaire Coalescing Mufflers

Dimensions in Inches (mm)

- Easily replaceable cartridge element
- Removal of oil mist from exhaust air provides cleaner work environment.
- Rugged, corrosion resistant construction

## Technical Data

Maximum Pressure: 300 psig (20.7 bar)  
 Maximum temperature: 160°F (71°C)

## Materials

Element: Fiberglass  
 Base: Aluminum  
 Shell: Plated steel

## Replacement Kit

Element Cartridge: 70039-01

## Graphic Symbol

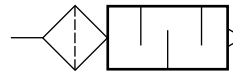

Male Thread

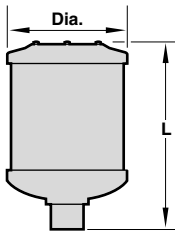

| Port Size NPT | Part Number | Flow Factor Cv | Dimensions Dia. | L          |
|---------------|-------------|----------------|-----------------|------------|
| 1/2           | MC004A      | 5.2            | 3.88 (99)       | 6.00 (152) |
| 3/4           | MC006A      | 9.2            | 3.88 (99)       | 6.00 (152) |
| 1             | MC008A      | 15.7           | 3.88 (99)       | 6.19 (157) |

## Performance Characteristics

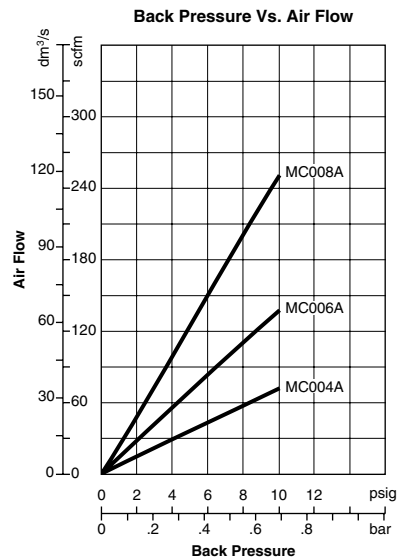
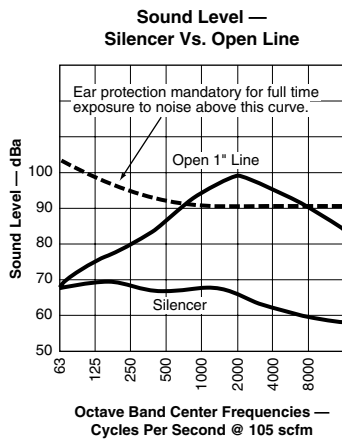



# High Performance Coalescing Quietaire Mufflers

Dimensions in Inches (mm)



- Easily replaceable cartridge element
- Corrosion resistant construction
- Snap-on liquid sump with manual drain to collect coalesced oil.
- High-performance cartridge removes up to 99% of the oil mist from the exhaust air.

## Technical Data

Maximum Pressure: 150 psig (10.3 bar)  
 Maximum Temperature: 160°F (71°C)

## Materials

Element: Steel, synthetic foam and fiber  
 Body: Aluminum  
 Sump: Polypropylene  
 Elastomer: Nitrile

## Replacement Kits

Element:  
 MQ004A and MQ006A – 3236-01  
 MQ008A and MQ010A – 3237-01  
 Sump with Drain:  
 MQ004A and MQ006A – 70048-50  
 MQ008A and MQ010A – 70048-51

## Graphic Symbol

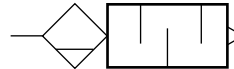

## Female Thread

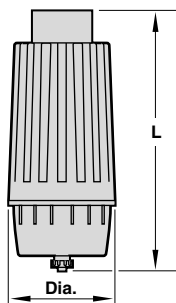

| Port Size<br>NPT | Part Number   | Flow Factor<br>Cv | Dimensions<br>Dia. | L           |
|------------------|---------------|-------------------|--------------------|-------------|
| 1/2              | <b>MQ004A</b> | 2.5               | 3.54 (90)          | 7.09 (180)  |
| 3/4              | <b>MQ006A</b> | 2.5               | 3.54 (90)          | 7.09 (180)  |
| 1                | <b>MQ008A</b> | 7.7               | 4.33 (110)         | 10.51 (267) |
| 1-1/4            | <b>MQ010A</b> | 7.7               | 4.33 (110)         | 10.51 (267) |

## Performance Characteristics

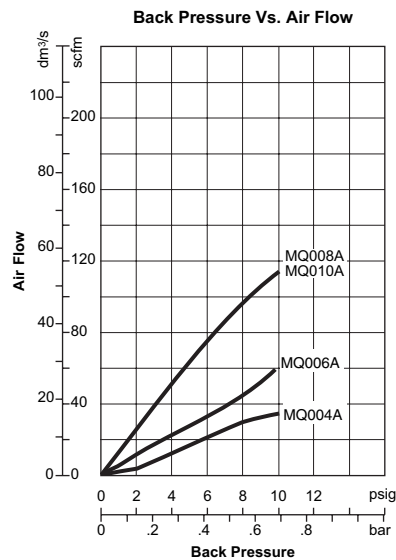
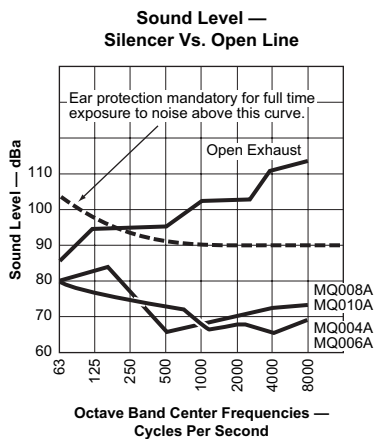



# Quietaire Speed Control Mufflers

Dimensions in Inches (mm)

- Cleanable 40-micron sintered bronze diffuser element.
- Corrosion resistant construction.
- Adjustment screw to control rate of exhaust air flow.
- Adjustment screw facilitates a smooth, steady change to flow when turned.

## Technical Data

Maximum Pressure: 300 psig (20.7 bar)  
 Maximum temperature: 160F (71°C)

## Materials

Element: Sintered bronze  
 Base: Brass

## Graphic Symbols

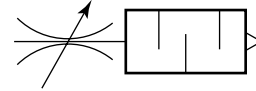

## Male Thread

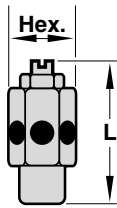

| Port Size<br>NPT | Part Number | Dimensions |           |
|------------------|-------------|------------|-----------|
|                  |             | Dia.       | L         |
| 1/8              | MM001A      | 1/2        | 1.53 (39) |
| 1/4              | MM002A      | 9/16       | 1.91 (49) |
| 3/8              | MM003A      | 11/16      | 1.91 (49) |
| 1/2              | MM004A      | 7/8        | 2.34 (59) |
| 3/4              | MM006A      | 1-1/16     | 2.84 (72) |
| 1                | MM008A      | 1-5/16     | 3.03 (77) |

## Performance Characteristics

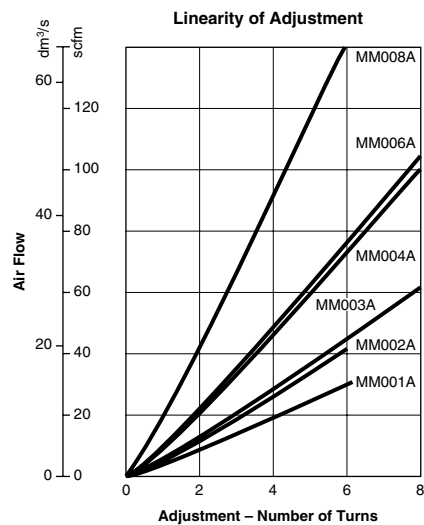
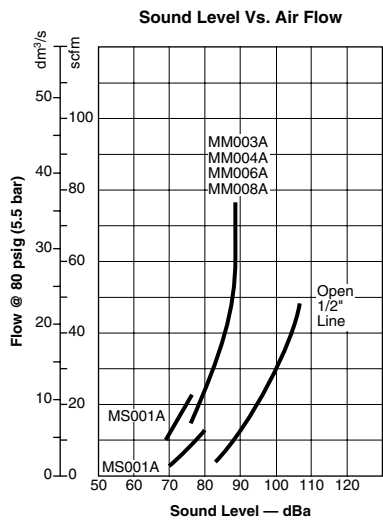

# Quietaire Speed Control Mufflers (plastic bodied) T20 Series

M5, 1/8 - 1/2 NPT and ISO G



- Compact, integral speed control and silencer units
- Captive adjustment screw will not blow out when unscrewed
- Reduced dimensions
- Low cost alternative to metal designs
- 75 Micron

## Ordering information

To order quote model number from table overleaf, e.g. T20A4800 for the regulator/silencer 1/2" NPT speed control muffler.

## Flow Regulator/Silencer

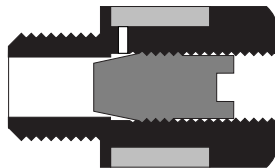
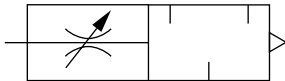

## Technical Data

Medium:

Compressed air, filtered, lubricated and non-lubricated, inert gases

Mounting:

Threads directly in the exhaust port. (Thread into port until washer under the element bottoms against the port surface.)

Hex recess adjustment for flow regulation

Port Sizes: Male Thread

| NPT                 | Metric       | ISO G                |
|---------------------|--------------|----------------------|
| 1/8 <b>T20A1800</b> | M5* T20M0500 | G1/8 <b>T20C1800</b> |
| 1/4 <b>T20A2800</b> |              | G1/4 <b>T20C2800</b> |
| 3/8 <b>T20A3800</b> |              | G3/8 <b>T20C3800</b> |
| 1/2 <b>T20A4800</b> |              | G1/2 <b>T20C4800</b> |

Note: Due to the pliable nature of the thermoplastic base these may be used in conjunction with 10-32 UNF ports.

Operating Pressure:

0 - 145 psi (0 - 10 bar)

Operating Temperature:

-0° to 175°F\* (-20° to 80° C)

\*Air supply must be dry enough to avoid ice formation at temperatures below 36°F (2°C)

## Materials:

Nylon body and washer

(Note: NPT models black, metric and ISO G models red)

Porous polyethylene silencer

Zinc electroplated high tensile steel adjusting screw

**M5**

Nylon body

Zinc electroplated high tensile steel adjusting screw



# Quietaire Speed Control Mufflers

Dimensions in Inches (mm)

## General Information

| Port Size | Part Number |                 | Max. Flow Factor Cv* | Dimensions     |                |                |          |       |              |                | Weight oz. (g) |
|-----------|-------------|-----------------|----------------------|----------------|----------------|----------------|----------|-------|--------------|----------------|----------------|
|           | NPT         | Metric or ISO G |                      | A              | B              | C              | Thread D | E A/F | F A/F        | G              |                |
| M5        | -           | T20M0500        | 0.07                 | 0.63<br>(16)   | 0.43<br>(16)   | -              | M5       | 1.5   | 0.31<br>(8)  | 0.36<br>(9.25) | .04 (1)        |
| 1/8       | T20A1800    | T20C1800        | 0.4                  | 0.81<br>(20.5) | 0.57<br>(14.5) | 0.20<br>(5)    | 1/8      | 2.5   | 0.51<br>(13) | 0.59<br>(15)   | .11 (3)        |
| 1/4       | T20A2800    | T20C2800        | 0.8                  | 1.14<br>(29)   | 0.87<br>(22)   | 0.27<br>(7)    | 1/4      | 2.5   | 0.59<br>(15) | 0.71<br>(18)   | .25 (7)        |
| 3/8       | T20A3800    | T20C3800        | 1.7                  | 1.50<br>(38)   | 1.18<br>(30)   | 0.41<br>(10.5) | 3/8      | 2.5   | 0.79<br>(20) | 0.94<br>(24)   | .67 (19)       |
| 1/2       | T20A4800    | T20C4800        | 2.4                  | 1.97<br>(50)   | 1.57<br>(40)   | 0.59<br>(15)   | 1/2      | 2.5   | 0.98<br>(25) | 1.18<br>(30)   | 1.52 (43)      |

\*Cv measured in US gal/min

### Speed Control Muffler (1/8 - 1/2 pipe)

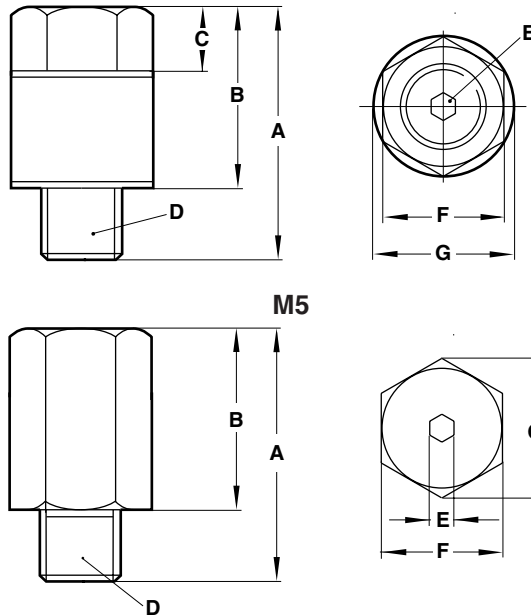

### Performance Characteristics Flow vs Turns

(at 90 psig [6 bar] inlet pressure)

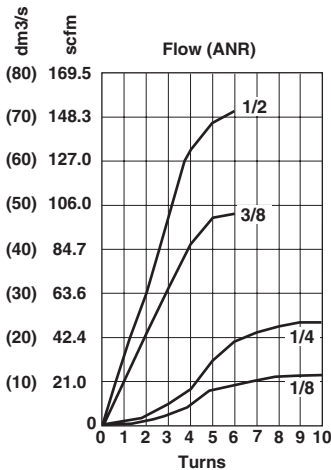

### Performance Characteristics Flow vs Turns

(at 90 psig [6 bar] inlet pressure)

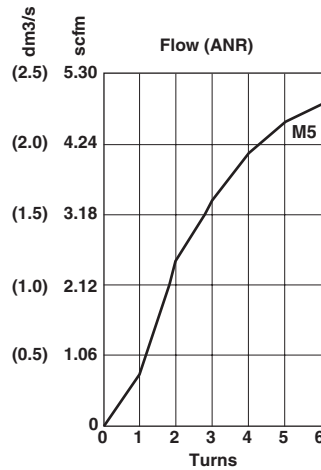



- Corrosion resistant construction
- Prevents contamination from dirt
- Rugged and compact
- Screws directly into the exhaust port
- Sintered bronze element

### Technical Data

Maximum Pressure: 150 psig (10.7 bar)  
 Maximum temperature: NPT - 300°F (149°C)  
 ISO - 175°F (80°C)

### Materials

NPT:

Base - Nickel plated steel  
 Element - Sintered bronze

ISO G:

Base - Aluminum  
 Element - Sintered bronze

### Graphic Symbol

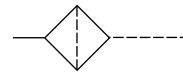

### Male Thread

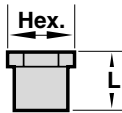

| Port Size NPT | Part Number | Flow Factor Cv | Dimensions Hex A/F | Dimensions L |
|---------------|-------------|----------------|--------------------|--------------|
| 1/8           | MV001A      | 0.1            | 7/16               | 0.44 (11)    |
| 1/4           | MV002A      | 0.1            | 9/16               | 0.63 (16)    |
| 3/8           | MV003A      | 0.3            | 11/16              | 0.75 (19)    |
| 1/2           | MV004A      | 0.5            | 7/8                | 0.88 (22)    |
| 3/4           | MV006A      | 1.3            | 1-1/16             | 1.00 (25)    |
| 1             | MV008A      | 1.6            | 1-5/16             | 1.31 (33)    |
| 1-1/4         | MV010A      | 4.2            | 1-11/16            | 1.44 (37)    |
| 1-1/2         | MV012A      | 5.2            | 2                  | 1.50 (38)    |

### Performance Characteristics

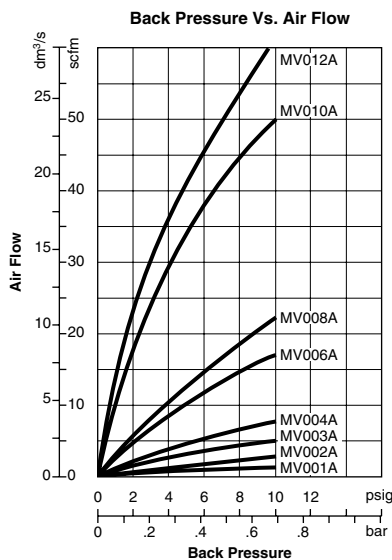

| Port Size ISO G | Part Number | Flow Factor Cv | Dimensions Hex A/F | Dimensions L | Weight oz. (g) |
|-----------------|-------------|----------------|--------------------|--------------|----------------|
| 1/8             | M/1511      | 0.45           | 15.0 mm            | 0.63 (16)    | 0.2 (6)        |
| 1/4             | M/1512      | 1.1            | 23.5 mm            | 0.87 (22)    | 0.6 (18)       |
| 1/2             | M/1514      | 1.5            | 30.5 mm            | 0.98 (25)    | 1.0 (30)       |
| 3/4             | M/1516      | 3.9            | 42.5 mm            | 1.22 (31)    | 1.6 (50)       |
| 1               | M/1518      | 5.5            | 47 mm              | 1.38 (35)    | 2.9 (91)       |



# Quietaire Small Part Ejectors

Dimensions in Inches (mm)

- Reduction in noise and in air consumption (when compared to an open pipe) with only a minor reduction in thrust.
- Corrosion resistant construction.

### Technical Data

Maximum Pressure: 150 psig (10.3 bar)  
 Maximum temperature: 160°F (71°C)  
 Force at 12" (305 mm) from Ejector at 80 psig (5.5 bar) line pressure  
 ME002A: 34 ozs. (9.5N)  
 Air Consumption at 80 psig (5.5 bar): 63 scfm (29.7 dm<sup>3</sup>/s)

### Materials

Element: Brass cloth  
 Base: Aluminum

### Graphic Symbol

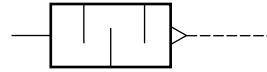

### Female Thread

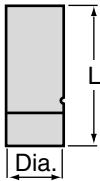

| Port Size NPT | Part Number | Flow Factor Cv | Dimensions Dia. | L         |
|---------------|-------------|----------------|-----------------|-----------|
| 1/4           | ME002A      | 1.0            | .81 (21)        | 1.84 (47) |

### Performance Characteristics

