

PNOZ mml2p

PILZ
THE SPIRIT OF SAFETY

- ▶ Configurable compact control systems PNOZmulti Mini

This document is a translation of the original document.

All rights to this documentation are reserved by Pilz GmbH & Co. KG. Copies may be made for internal purposes. Suggestions and comments for improving this documentation will be gratefully received.

Source code from third-party manufacturers or open source software has been used for some components. The relevant licence information is available on the Internet on the Pilz homepage.

Pilz®, PIT®, PMI®, PNOZ®, Primo®, PSEN®, PSS®, PVIS®, SafetyBUS p®, SafetyEYE®, SafetyNET p®, the spirit of safety® are registered and protected trademarks of Pilz GmbH & Co. KG in some countries.



SD means Secure Digital

Section 1	Introduction	5
	1.1 Validity of documentation	5
	1.2 Using the documentation	5
	1.3 Definition of symbols	5
Section 2	Overview	7
	2.1 Scope of supply	7
	2.2 Unit features	7
	2.3 Front view	8
Section 3	Safety	9
	3.1 Intended use	9
	3.2 System requirements	9
	3.3 Safety regulations	9
	3.3.1 Safety assessment	9
	3.3.2 Use of qualified personnel	10
	3.3.3 Warranty and liability	10
	3.3.4 Disposal	10
	3.3.5 For your safety	10
Section 4	Function description	11
	4.1 Integrated protection mechanisms	11
	4.2 Operation	11
	4.3 Block diagram	12
Section 5	Installation	13
	5.1 General installation guidelines	13
	5.2 Dimensions	13
	5.3 Connect the base unit and expansion modules	14
Section 6	Commissioning	15
	6.1 General wiring guidelines	15
	6.1.1 Insulation voltage test	15
	6.2 Download modified project to the PNOZmulti system	15
	6.3 Connection	16
	6.4 Series connection of 4 decentralised modules	17
	6.5 Voltage drop	17
	6.5.1 Guidelines for various cable types	17
	6.5.2 Calculation example	18
Section 7	Operation	19
	7.1 LED indicators	19
	7.2 Fault detection	19

Section 8	Technical details	20
Section 9	Order reference	23
	9.1 Product	23
	9.2 Accessories	23

1 Introduction

1.1 Validity of documentation

This documentation is valid for the product PNOZ mml2p. It is valid until new documentation is published.

This operating manual explains the function and operation, describes the installation and provides guidelines on how to connect the product.

1.2 Using the documentation

This document is intended for instruction. Only install and commission the product if you have read and understood this document. The document should be retained for future reference.

1.3 Definition of symbols

Information that is particularly important is identified as follows:



DANGER!

This warning must be heeded! It warns of a hazardous situation that poses an immediate threat of serious injury and death and indicates preventive measures that can be taken.



WARNING!

This warning must be heeded! It warns of a hazardous situation that could lead to serious injury and death and indicates preventive measures that can be taken.



CAUTION!

This refers to a hazard that can lead to a less serious or minor injury plus material damage, and also provides information on preventive measures that can be taken.



NOTICE

This describes a situation in which the product or devices could be damaged and also provides information on preventive measures that can be taken. It also highlights areas within the text that are of particular importance.

**INFORMATION**

This gives advice on applications and provides information on special features.

2 Overview

2.1 Scope of supply

- ▶ Expansion module PNOZ mml2p
- ▶ Jumper

2.2 Unit features

Using the product PNOZ mml2p:

Link module to safely connect decentralised input/output modules to a configurable control system PNOZmulti Mini.

The product has the following features:

- ▶ Can be configured in the PNOZmulti Configurator
- ▶ Max. 4 PNOZ mml2p can be connected to the base unit
- ▶ Max. 4 decentralised modules can be connected to the link module PNOZ mml2p
- ▶ LEDs for
 - Operating state
 - Error
 - Connection status
- ▶ Plug-in connection terminals:
either spring-loaded terminal or screw terminal available as an accessory (see order reference)

2.3 Front view

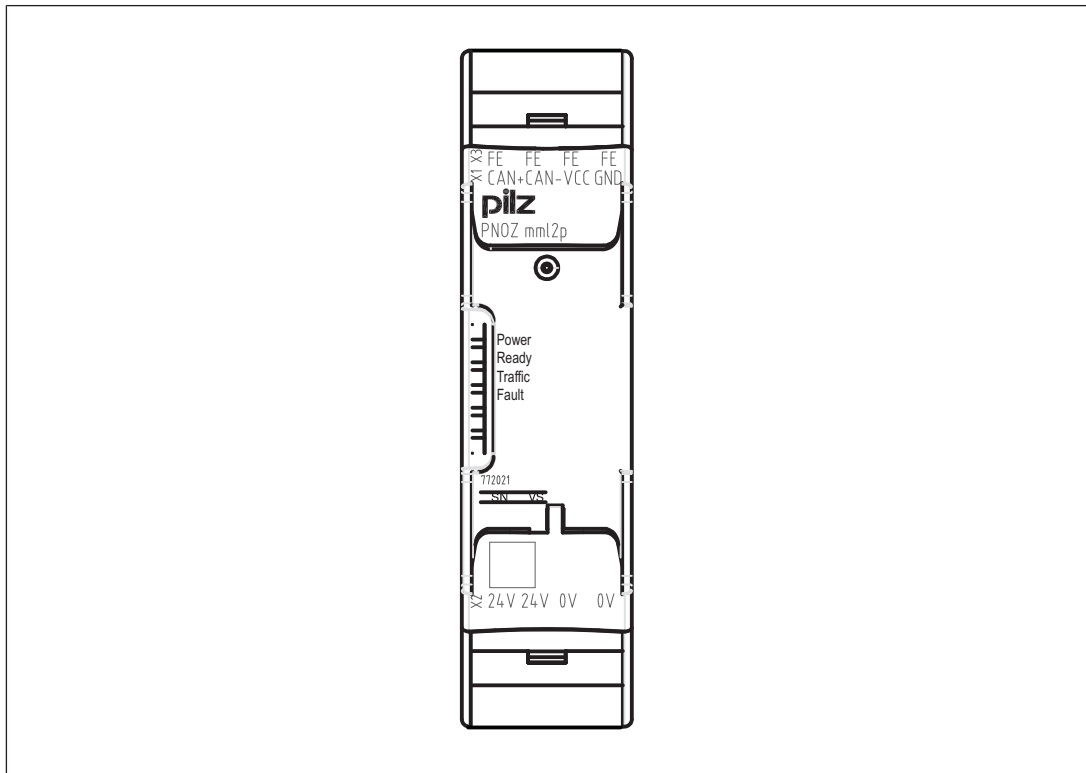

Key:

- ▶ 0 V, 24 V:
Supply connections
- ▶ CAN+, CAN-, VCC, GND:
Connection for decentralised modules
- ▶ FE:
Functional earth

3 Safety

3.1 Intended use

The expansion module is used to connect decentralised input/output modules to a configurable control system PNOZmulti Mini .

The expansion module may only be connected to a base unit from the configurable system PNOZmulti Mini (please refer to the document "PNOZmulti System Expansion" for details of the base units that can be connected).

The configurable small control systems PNOZmulti are used for the safety-related interruption of safety circuits and are designed for use in:

- ▶ E-STOP equipment
- ▶ Safety circuits in accordance with VDE 0113 Part 1 and EN 60204-1

The following is deemed improper use in particular:

- ▶ Any component, technical or electrical modification to the product
- ▶ Use of the product outside the areas described in this manual
- ▶ Use of the product outside the technical details (see [Technical details](#) [ 20]).



NOTICE

EMC-compliant electrical installation

The product is designed for use in an industrial environment. The product may cause interference if installed in other environments. If installed in other environments, measures should be taken to comply with the applicable standards and directives for the respective installation site with regard to interference.

3.2 System requirements

Please refer to the "Product Modifications PNOZmulti" document in the "Version overview" section for details of which versions of the base unit and PNOZmulti Configurator can be used for this product.

3.3 Safety regulations

3.3.1 Safety assessment

Before using a unit it is necessary to perform a safety assessment in accordance with the Machinery Directive.

Functional safety is guaranteed for the product as a single component. However, this does not guarantee the functional safety of the overall plant/machine. In order to achieve the required safety level for the overall plant/machine, define the safety requirements for the plant/machine and then define how these must be implemented from a technical and organisational standpoint.

3.3.2 Use of qualified personnel

The products may only be assembled, installed, programmed, commissioned, operated, maintained and decommissioned by competent persons.

A competent person is someone who, because of their training, experience and current professional activity, has the specialist knowledge required to test, assess and operate the work equipment, devices, systems, plant and machinery in accordance with the general standards and guidelines for safety technology.

It is the company's responsibility only to employ personnel who:

- ▶ Are familiar with the basic regulations concerning health and safety / accident prevention
- ▶ Have read and understood the information provided in this description under "Safety"
- ▶ And have a good knowledge of the generic and specialist standards applicable to the specific application.

3.3.3 Warranty and liability

All claims to warranty and liability will be rendered invalid if

- ▶ The product was used contrary to the purpose for which it is intended
- ▶ Damage can be attributed to not having followed the guidelines in the manual
- ▶ Operating personnel are not suitably qualified
- ▶ Any type of modification has been made (e.g. exchanging components on the PCB boards, soldering work etc.).

3.3.4 Disposal

- ▶ In safety-related applications, please comply with the mission time T_M in the safety-related characteristic data.
- ▶ When decommissioning, please comply with local regulations regarding the disposal of electronic devices (e.g. Electrical and Electronic Equipment Act).

3.3.5 For your safety

The unit meets all the necessary conditions for safe operation. However, you should always ensure that the following safety requirements are met:

- ▶ This operating manual only describes the basic functions of the unit. The expanded functions are described in the PNOZmulti Configurator's online help. Only use these functions once you have read and understood the documentations.
- ▶ Do not open the housing or make any unauthorised modifications.
- ▶ Please make sure you shut down the supply voltage when performing maintenance work (e.g. exchanging contactors).

4 Function description

4.1 Integrated protection mechanisms

The relay conforms to the following safety criteria:

- ▶ The circuit is redundant with built-in self-monitoring.
- ▶ The safety function remains effective in the case of a component failure.

4.2 Operation

The link module PNOZ mml2p is used to safely transfer the input information from decentralised modules to the safety system PNOZmulti.

The function of the inputs and outputs on the control system depends on the safety circuit created using the PNOZmulti Configurator. A chip card is used to download the safety circuit to the base unit. The base unit has 2 microcontrollers that monitor each other. They evaluate the input circuits on the base unit and expansion modules and switch the outputs on the base unit and expansion modules accordingly.

The LEDs on the base unit and expansion modules indicate the status of the configurable control system PNOZmulti.

The online help on the PNOZmulti Configurator contains descriptions of the operating modes and all the functions of the control system, plus connection examples.

Data exchange:

- ▶ Communication with the decentralised modules is via a safe data link.
- ▶ The link module PNOZ mml2p reads the input information from the decentralised modules as part of each cycle and then forwards it to the base unit.
- ▶ At the end of a PNOZmulti cycle, the base unit sends its output data to its link module. This output data is immediately sent to the decentralised modules.

Linking several decentralised modules:

- ▶ A maximum of 4 link modules can be connected to a base unit PNOZmulti Mini.
- ▶ A maximum of 4 decentralised modules can be connected to a link module PNOZ mml2p.
- ▶ If a decentralised module receives data intended for a different decentralised module that is connected, the data is forwarded without being processed.

4.3 Block diagram

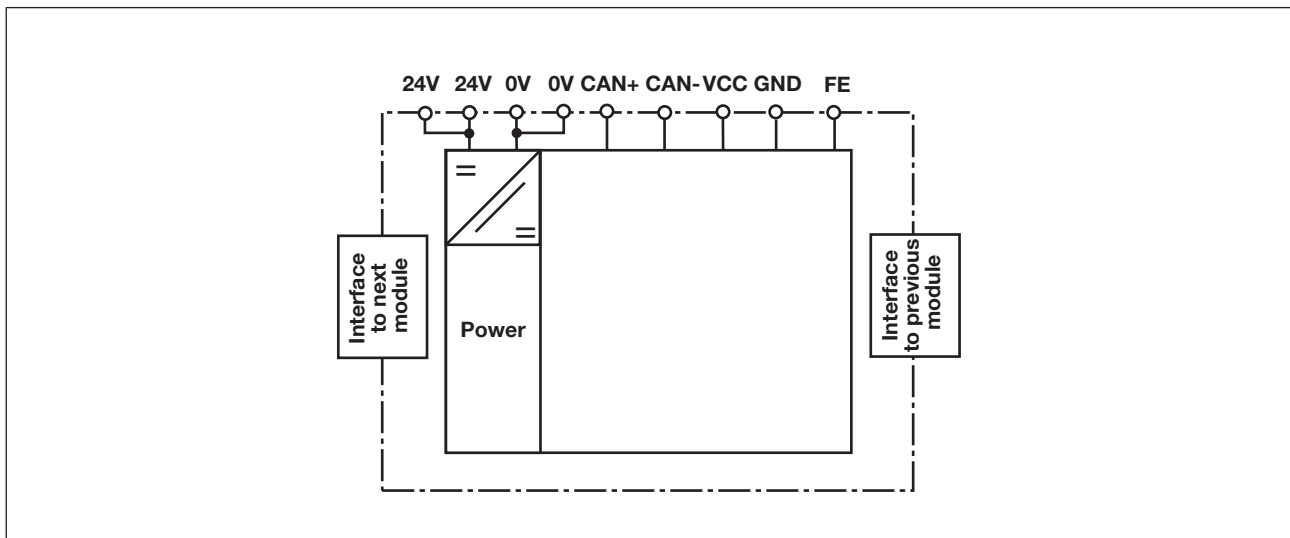

5 Installation

5.1 General installation guidelines

- ▶ The unit should be installed in a control cabinet with a protection type of at least IP54.
- ▶ Fit the safety system to a horizontal mounting rail. The venting slots must face upwards and downwards. Other mounting positions could destroy the safety system.
- ▶ Use the notch on the rear of the unit to attach it to a mounting rail.
- ▶ In environments exposed to heavy vibration, the unit should be secured using a fixing element (e.g. retaining bracket or end angle).
- ▶ Push the unit upwards or downwards before lifting it from the mounting rail.
- ▶ To comply with EMC requirements, the mounting rail must have a low impedance connection to the control cabinet housing.
- ▶ The ambient temperature of the PNOZmulti units in the control cabinet must not exceed the figure stated in the technical details, otherwise air conditioning will be required.



NOTICE

Damage due to electrostatic discharge!

Electrostatic discharge can damage components. Ensure against discharge before touching the product, e.g. by touching an earthed, conductive surface or by wearing an earthed armband.

5.2 Dimensions

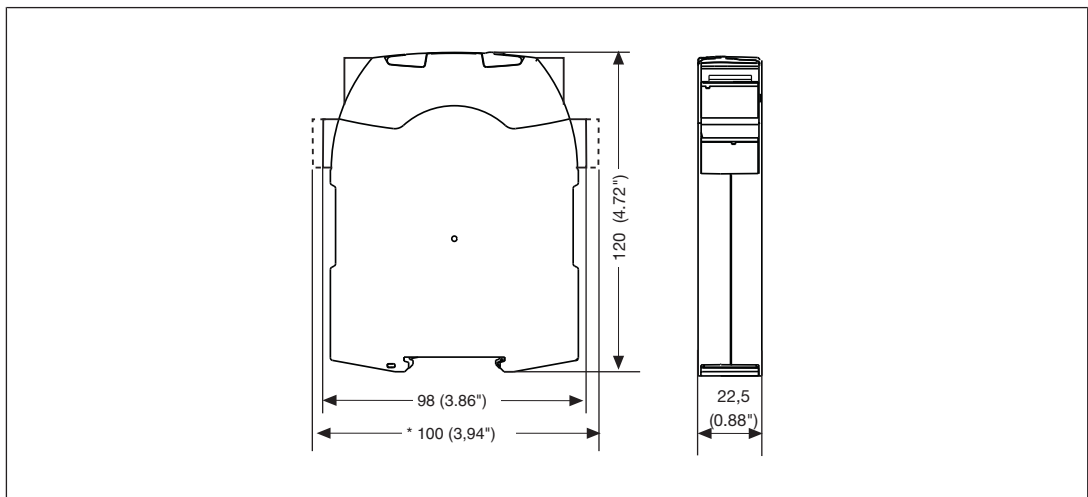

5.3 Connect the base unit and expansion modules

Connect the base unit and the expansion module as described in the operating instructions for the base units.

- ▶ Connect the black/yellow terminator to the expansion module.
- ▶ Install the expansion module in the position in which it is configured in the PNOZmulti Configurator.

The position of the expansion modules is defined in the PNOZmulti Configurator. The expansion modules are connected to the left or right of the base unit, depending on the type.





Please refer to the document "PNOZmulti System Expansion" for details of the number of modules that can be connected to the base unit and the module types.

6 Commissioning

6.1 General wiring guidelines

The wiring is defined in the circuit diagram of the PNOZmulti Configurator.

Please note:

- ▶ Information given in the [Technical details](#) [ 20] must be followed.
- ▶ Use copper wire that can withstand 75° C.
- ▶ External measures must be used to connect the FE terminal to the function earth (e.g. mounting rail).
- ▶ The power supply must meet the regulations for extra low voltages with protective separation.
- ▶ Two connection terminals are available for each of the supply connections 24 V and 0 V (semiconductor outputs), plus A1 and A2 (power supply). This means that the supply voltage can be looped through several connections. When the supply voltage is looped, the current at each terminal may not exceed 3 A.
- ▶ Please refer to the technical details for information on the maximum cable length. Please also read the section entitled [Voltage drop](#) [ 17].
- ▶ Shielded cable must be used from a cable length of 30 m.
- ▶ Pilz pre-assembled cable can be used to connect the decentralised modules (see [Order references](#) [ 23]).
- ▶ The plug-in connection terminals are either designed as cage clamp terminals or screw terminals (see [Order references](#) [ 23]).



CAUTION!

Only connect and disconnect the expansion module when the supply voltage is switched off.

6.1.1 Insulation voltage test

The product PNOZ mml2p is connected to functional earth  via protection elements on the supply voltage. Insulation voltage tests are only possible with voltages up to ca. 42 V.

6.2 Download modified project to the PNOZmulti system

As soon as an additional expansion module has been connected to the system, the project must be amended using the PNOZmulti Configurator. Proceed as described in the operating instructions for the base unit.



NOTICE

For the commissioning and after every program change, you must check whether the safety devices are functioning correctly.

6.3 Connection

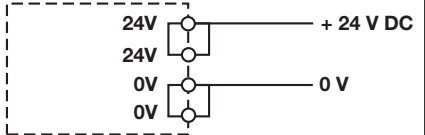
Supply voltage	AC	DC
	/	

Supply voltage

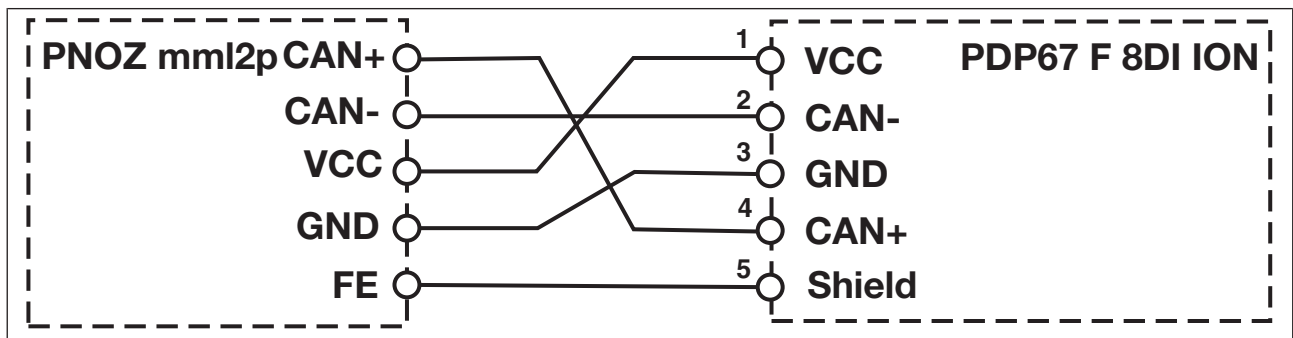

Connection to a decentralised input module PDP67

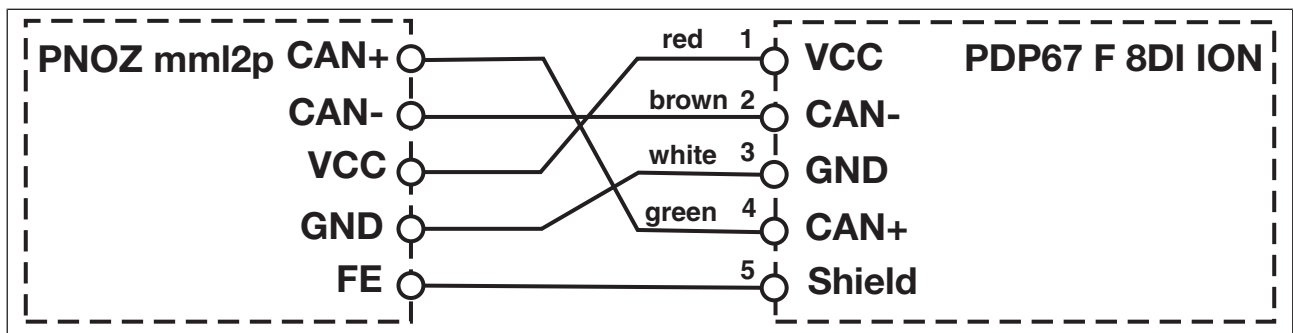

Connection when using the PSS SB BUSCABLE LC in conjunction with a Pilz self-assembly "PSS67 M12 connector" (see order reference in the Technical Catalogue)

6.4 Series connection of 4 decentralised modules

You can connect up to 4 decentralised modules in series to a PNOZmulti link module.

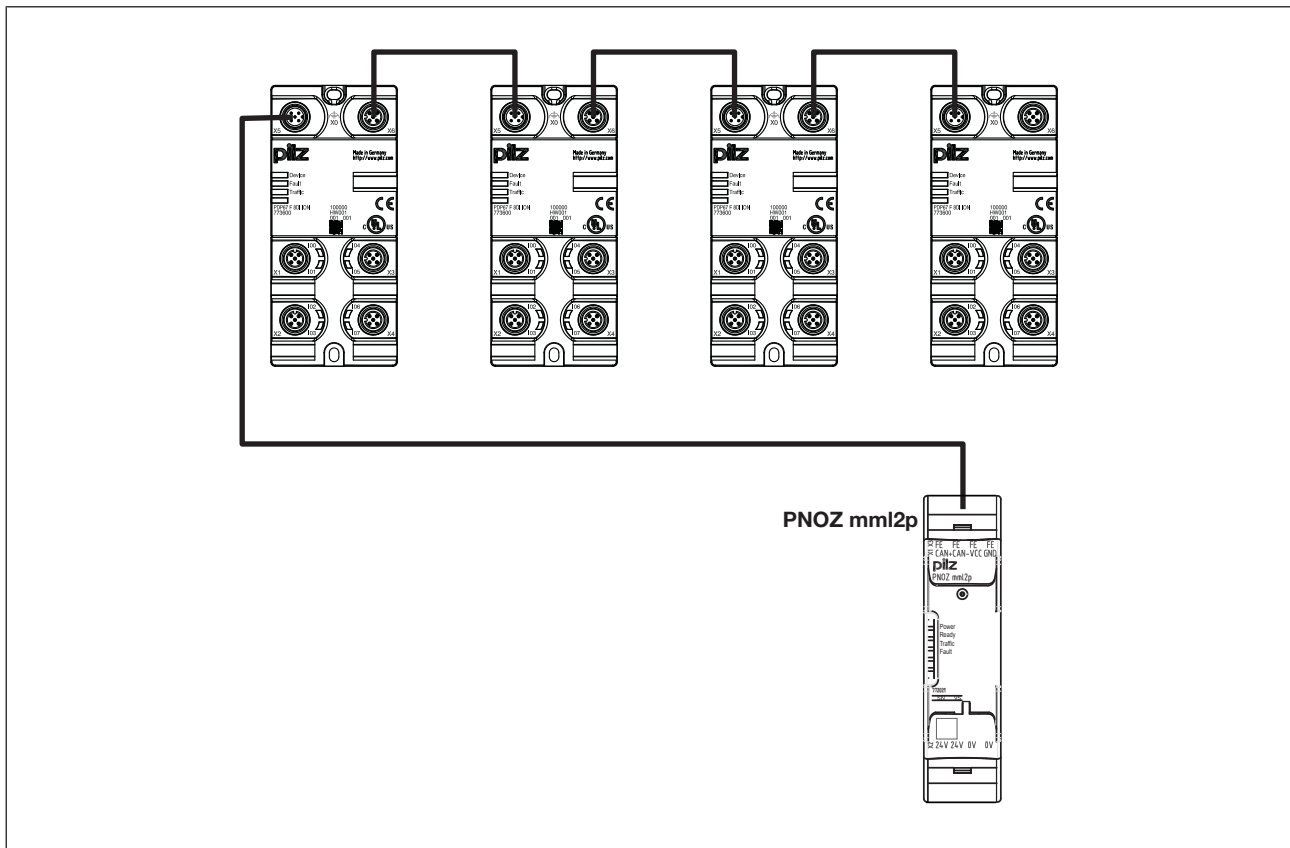

6.5 Voltage drop

The max. cable length depends on the voltage drop in the supply voltage cables. The level of voltage drop is determined by the:

- ▶ Cable resistance on the supply voltage cables
- ▶ Operating current of the modules
- ▶ Load on the modules

To increase the max. cable length, the input voltage can be permanently increased by the voltage tolerance (see Technical Details).

6.5.1 Guidelines for various cable types

Cable type	Voltage drop per 10 m and per 100 mA
PSS SB BUSCABLE LC	0.1 V
Sensor cable 0.25 mm ²	0.15 V
Sensor cable 0.34 mm ²	0.11 V
Sensor cable 0.5 mm ²	0.07 V

6.5.2 Calculation example

- ▶ The PSS SB BUSCABLE LC is used in accordance with the pin assignment in section 6.2.2.

Voltage drop per 10 m and per 100 mA: 0.1 V

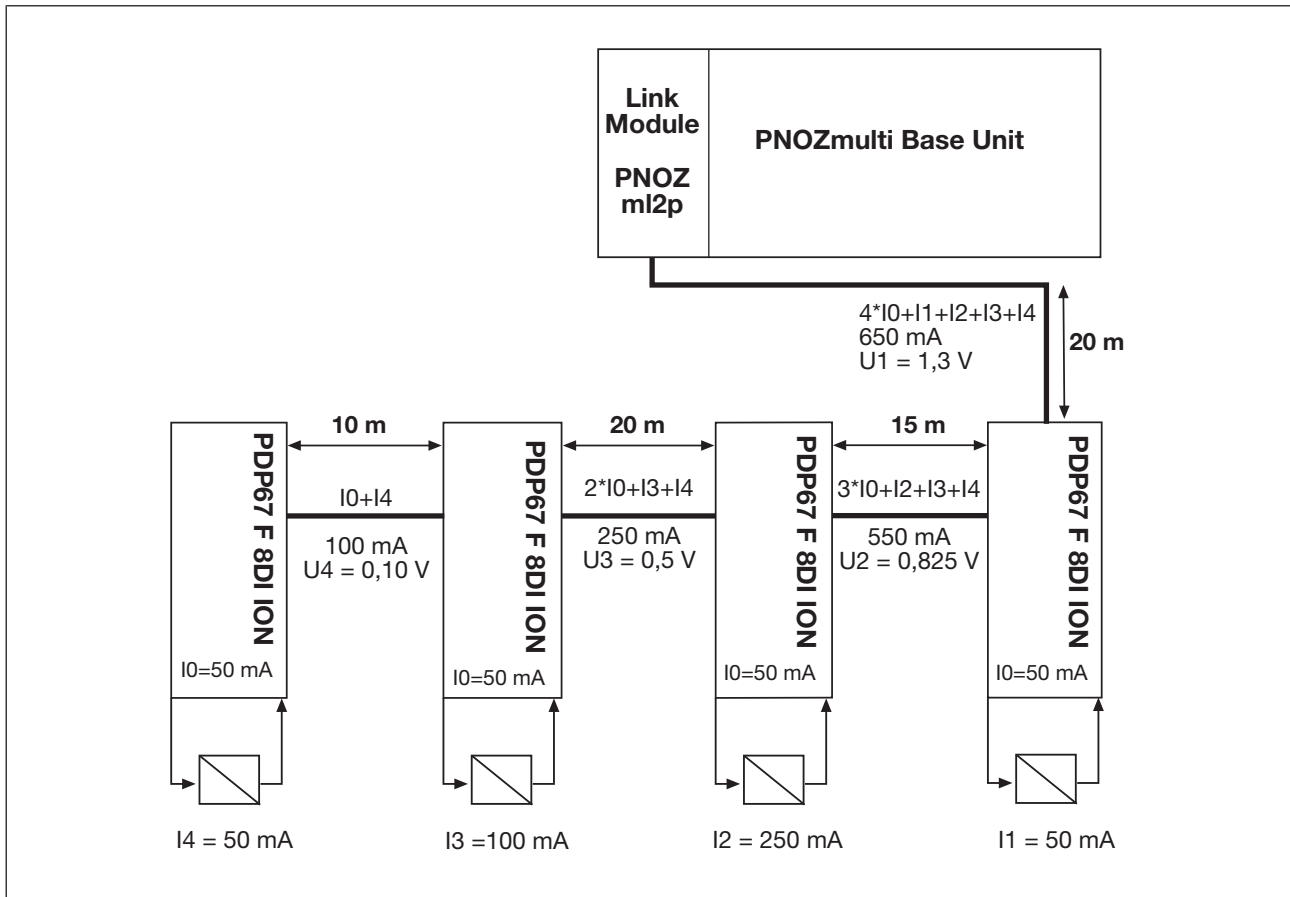

Key:

- ▶ I_0 : Module's consumption.
- ▶ $I_1 \dots I_5$: Load current taken from the module
- ▶ $U_1 \dots U_4$: Voltage drop on the respective connection path

Total voltage drop from the link module PNOZ mml2p to the final PDP67 F 8DI ION:

$$U_{\text{total}} = U_1 + U_2 + U_3 + U_4$$

$$U_{\text{total}} = 1.3 \text{ V} + 0.825 \text{ V} + 0.5 \text{ V} + 0.10 \text{ V} = 2.725 \text{ V}$$

7 Operation



When the supply voltage is switched on, the PNOZmulti safety system copies the configuration from the chip card.







The LEDs "POWER", "DIAG", "FAULT", "IFAULT" and "OFAULT" will light up on the base unit.

The PNOZmulti safety system is ready for operation when the "POWER" and "RUN" LEDs on the base unit and the "READY" LED on the PNOZ mml2p are lit continuously.

7.1 LED indicators

Legend

-  LED on
-  LED flashes
-  LED off

LED	LED status		Meaning
Power	●		No supply voltage
		Green	Supply voltage is present
Ready		Green	The unit is ready for operation
	●		The unit is not ready for operation
Fault		Red	External error
		Red	Internal error
	●		No fault
Traffic		Yellow	Connection to a decentralised module available
		Yellow	Connection is not available to all decentralised modules.
	●		No connection to a decentralised module

7.2 Fault detection

The base unit contains information about the

- ▶ Link module (in order, defective, no supply voltage)
- ▶ Status of communication with the decentralised modules (data valid, data invalid)

If the connection to a decentralised module is interrupted or there is a major error on the decentralised module, the inputs on the devices connected to the link module are set to zero. The base unit remains in a RUN condition.

8 Technical details

General	
Approvals	BG, CCC, CE, EAC (Eurasian), TÜV, cULus Listed
Electrical data	
Supply voltage	
for	Module supply
Voltage	24,0 V
Kind	DC
Voltage tolerance	-15 %/+20 %
Output of external power supply (DC)	101,0 W
Output of external power supply (DC) at no load	5,0 W
Residual ripple DC	5 %
Status indicator	LED
Inputs	
Maximum input delay	15 ms
Semiconductor outputs	
Switch-off delay	35 ms
Test pulse outputs	
Maximum output current, decentralised module supply	4 A
Short circuit protection of decentralised module supply	yes
Times	
Switch-on delay	5,00 s
Supply interruption before de-energisation	20 ms
Environmental data	
Ambient temperature	
In accordance with the standard	EN 60068-2-14
Temperature range	0 - 60 °C
Storage temperature	
In accordance with the standard	EN 60068-2-1/-2
Temperature range	-25 - 70 °C
Climatic suitability	
In accordance with the standard	EN 60068-2-30, EN 60068-2-78
Humidity	93 % r. h. at 40 °C
Condensation during operation	Not permitted
EMC	EN 61131-2
Vibration	
In accordance with the standard	EN 60068-2-6
Frequency	10,0 - 150,0 Hz
Acceleration	1g

Environmental data	
Shock stress	
In accordance with the standard	EN 60068-2-27
Number of shocks	3
Acceleration	15g
Duration	11 ms
In accordance with the standard	EN 60068-2-27
Number of shocks	500
Acceleration	25g
Duration	6 ms
Max. operating height above sea level	2000 m
Airgap creepage	
Overvoltage category	II
Pollution degree	2
Rated insulation voltage	30 V
Rated impulse withstand voltage	0,50 kV
Protection type	
In accordance with the standard	EN 60529
Mounting area (e.g. control cabinet)	IP54
Housing	IP20
Terminals	IP20
Mechanical data	
Mounting position	Horizontal on top hat rail
DIN rail	
Top hat rail	35 x 7,5 EN 50022
Recess width	27 mm
Max. cable length unshielded	30 m
Max. cable length shielded	100 m
Material	
Bottom	PC
Front	PC
Top	PC
Connection type	Spring-loaded terminal, screw terminal
Conductor cross section with screw terminals	
1 core flexible	0,25 - 2,50 mm², 24 - 12 AWG
2 core with the same cross section, flexible without crimp connectors or with TWIN crimp connectors	0,20 - 1,50 mm², 24 - 16 AWG
Torque setting with screw terminals	0,50 Nm
Conductor cross section with spring-loaded terminals:	
Flexible with/without crimp connector	0,20 - 2,50 mm², 24 - 12 AWG
Spring-loaded terminals: Terminal points per connection	2
Stripping length with spring-loaded terminals	9 mm
Dimensions	
Height	100,0 mm
Width	22,5 mm
Depth	120,0 mm

Mechanical data

Weight	98 g
--------	-------------

Where standards are undated, the 2011-01 latest editions shall apply.

9 Order reference

9.1 Product

Product type	Features	Order No.
PNOZ mml2p	Link Module	772 021

9.2 Accessories

Adapter

Product type	Features	Order No.
PSEN ma adapter	Adapter for connection to safety switch PSENm _{ag}	380 300
PSEN cs adapter	Adapter for connection to safety switch PSENc _{ode}	380 301
PSEN sl adapter	Adapter for connection to safety switch PSENs _{lock}	380 325

Cable

Product type	Features	Order No.
PSS SB BUSCABLE LC	Cable, shielded, 1 - 100 m	311074
PSS67 I/O Cable	Cable, 1 - 30 m	380 320
PSS67 Cable M8sf M12sm	Cable, straight M12 connector, straight M8 socket, 4-pin, 3 m	380 200
PSS67 Cable M8sf M12sm	Cable, straight M12 connector, straight M8 socket, 4-pin, 5 m	380 201
PSS67 Cable M8sf M12sm	Cable, straight M12 connector, straight M8 socket, 4-pin, 10 m	380 202
PSS67 Cable M8sf M12sm	Cable, straight M12 connector, straight M8 socket, 4-pin, 30 m	380 203
PSS67 Cable M8af M12sm	Cable, straight M12 connector, angled M8 socket, 4-pin, 3m	380 204
PSS67 Cable M8af M12sm	Cable, straight M12 connector, angled M8 socket, 4-pin, 5 m	380 205
PSS67 Cable M8af M12sm	Cable, straight M12 connector, angled M8 socket, 4-pin, 10 m	380 206
PSS67 Cable M8af M12sm	Cable, straight M12 connector, angled M8 socket, 4-pin, 30 m	380 207
PSS67 Cable M12sf M12sm	Cable, straight M12 connector, straight M12 socket, 5-pin, 3m	380 208
PSS67 Cable M12sf M12sm	Cable, straight M12 connector, straight M12 socket, 5-pin, 5 m	380 209
PSS67 Cable M12sf M12sm	Cable, straight M12 connector, straight M12 socket, 5-pin, 10 m	380 210
PSS67 Cable M12sf M12sm	Cable, straight M12 connector, straight M12 socket, 5-pin, 20 m	380 220

Product type	Features	Order No.
PSS67 Cable M12sf M12sm	Cable, straight M12 connector, straight M12 socket, 5-pin, 30 m	380 211
PSS67 Cable M12af M12am	Cable, angled M12 connector, angled M12 socket, 5-pin, 3m	380 212
PSS67 Cable M12af M12am	Cable, angled M12 connector, angled M12 socket, 5-pin, 5 m	380 213
PSS67 Cable M12af M12am	Cable, angled M12 connector, angled M12 socket, 5-pin, 10 m	380 214
PSS67 Cable M12af M12am	Cable, angled M12 connector, angled M12 socket, 5-pin, 30 m	380 215
PSEN op cable axial M12 5-pole 3m	Cable, straight, M12, 5-pin, open-ended socket, 3 m	630310
PSEN op cable axial M12 5-pole 5m	Cable, straight, M12, 5-pin, open-ended socket, 5 m	630311
PSEN op cable axial M12 5-pole 10m	Cable, straight, M12, 5-pin, open-ended socket, 10 m	630312
PSEN op cable axial M12 5-pole 20m	Cable, straight, M12, 5-pin, open-ended socket, 20 m	630298
PSEN op cable axial M12 5-pole 30m	Cable, straight, M12, 5-pin, open-ended socket, 30 m	630297

Connection terminals

Product type	Features	Order No.
Spring terminals PNOZ mml2p 1 pc.	Spring-loaded terminals, 1 pieces	783 540
Spring terminals PNOZ mml2p 10 pcs.	Spring-loaded terminals, 10 pieces	783 541
Screw terminals PNOZ mml2p 1 pc.	Screw terminals, 1 piece	793 540
Screw terminals PNOZ mml2p 10 pcs.	Screw terminals, 10 pieces	793 541

Terminator, jumper

Product type	Features	Order No.
PNOZ mm0.xp connector left	Jumper yellow/black to connect the modules, 10 piece	779 260

Connector

Product type	Features	Order No.
PSS67 M12 connector	Connector, M12, straight, 5-pin, A-coded	380 308
PSS67 M12 connector	Socket, M12, straight, 5-pin, A-coded	380 309
PSS67 M12 connector	Connector, M12, angled, 5-pin, A-coded	380 310

Product type	Features	Order No.
PSS67 M12 connector	Socket, M12, angled, 5-pin, A-coded	380 311
PSS67 M8 connector	Connector, M8, straight, 4-pin	380 316
PSS67 M8 connector	Socket, M8, straight, 4-pin	380 317
PSS67 M8 connector	Connector, M8, angled, 4-pin	380 318
PSS67 M8 connector	Socket, M8, angled, 4-pin	380 319

► Support

Technical support is available from Pilz round the clock.

Americas

Brazil
+55 11 97569-2804

Canada
+1 888-315-PILZ (315-7459)

Mexico
+52 55 5572 1300

USA (toll-free)
+1 877-PILZUSA (745-9872)

Asia

China
+86 21 60880878-216

Japan
+81 45 471-2281

South Korea
+82 31 450 0680

Australia

+61 3 95446300

Europe

Austria
+43 1 7986263-0

Belgium, Luxembourg
+32 9 3217575

France
+33 3 88104000

Germany
+49 711 3409-444

Ireland
+353 21 4804983

Italy
+39 0362 1826711

Scandinavia

+45 74436332

Spain

+34 938497433

Switzerland

+41 62 88979-30

The Netherlands

+31 347 320477

Turkey

+90 216 5775552

United Kingdom

+44 1536 462203

You can reach our international hotline on:

+49 711 3409-444
support@pilz.com

Pilz develops environmentally-friendly products using ecological materials and energy-saving technologies. Offices and production facilities are ecologically designed, environmentally-aware and energy-saving. So Pilz offers sustainability, plus the security of using energy-efficient products and environmentally-friendly solutions.



Pilz GmbH & Co. KG
Felix-Wankel-Straße 2
73760 Ostfildern, Germany
Tel.: +49 711 3409-0
Fax: +49 711 3409-133
info@pilz.com
www.pilz.com

