

JUMO DICON touch

Two-channel process and program controller with
touchscreen 8.9 cm (3.5 ")

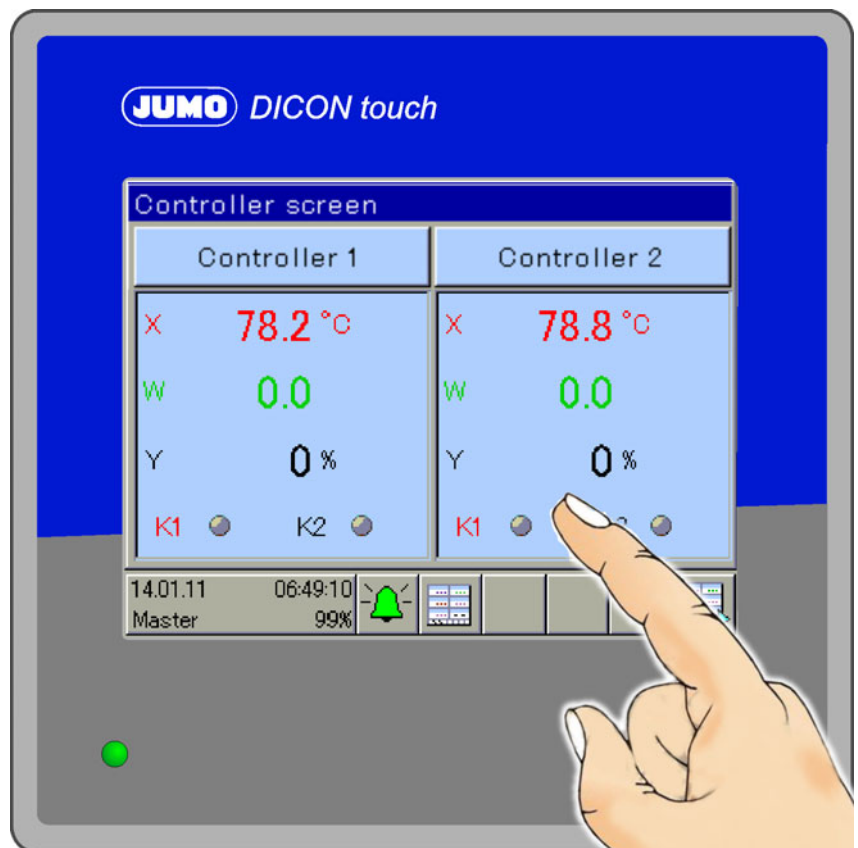

B 703571.0
Operating Manual



1	Introduction	9
1.1	Safety information	9
1.1.1	Warning symbols	9
1.1.2	Note signs	9
1.1.3	Representation	10
1.2	Description	11
1.3	Block diagram	12
2	Identifying the device version	13
2.1	Order details	14
2.2	Scope of delivery	16
2.3	General accessories	16
2.4	Accessories	17
2.5	Nameplate	18
3	Mounting	19
3.1	Mounting site and climatic conditions	19
3.1.1	Environmental influences	19
3.1.2	Case	19
3.1.3	Electrical data	20
3.2	Dimensions	21
3.3	Close mounting	21
3.4	Insertion in panel cut-out	22
3.5	Care and treatment of the front cover	22
4	Electrical connection	25
4.1	Installation notes	25
4.1.1	Cables, shielding, and grounding	25
4.1.2	Electrical safety	25
4.1.3	Intended use, misuse	25
4.2	Galvanic isolation	26
4.3	Connection diagram	27
4.3.1	Connection elements	27
4.3.2	Analog inputs	28
4.3.3	Analog outputs	29
4.3.4	Digital inputs	29
4.3.5	Digital outputs	29
4.3.6	Digital outputs	31
4.3.7	Voltage supply (according to nameplate)	32
4.3.8	Interfaces	32
5	Operation	35

5.1	Display and operating concept	35
5.2	Device menu	36
5.3	Alarm and event list	36
5.4	Function buttons, history and channel changeover	36
5.5	Images in the operating loop	37
5.5.1	Controller screen 1, Controller screen 2 and Controller overview	37
5.5.2	Program controller	39
5.5.3	General screen 1.2	40
5.5.4	Recording image	40
5.5.5	Process screen	41
6	Login	43
6.1	Logging on	44
6.2	Logging out	44
6.3	Changing the password	44
7	User level (Log-In)	45
7.1	Example 4 Transferring controller setpoint values to the user level	45
8	Program administration	47
8.1	Enter program curves	47
8.1.1	On the device	47
8.1.2	About the setup program	48
8.1.3	Section run time	49
8.1.4	Setpoint values 1 and 2	49
8.1.5	Control contacts	49
8.1.6	Tolerance band	50
8.1.7	Number of repetitions	50
8.1.8	Start section	50
8.1.9	Parameter block	50
9	Device information	51
9.1	General information	51
9.1.1	Version, motherboard, Ethernet information	51
9.2	Slots	51
9.3	Inputs/outputs	51
9.3.1	Digital and analog inputs, digital and analog outputs, external digital, and external analog inputs	52
9.4	Functions	52
9.4.1	Mathematics, logic signal, limit value outputs	52
9.4.2	Timer signal, digital controller signals, control contacts, controller, analog flag, digital flag	53
9.5	Status	53
9.5.1	Ethernet status 1 to 9	53

10	Functional level	55
10.1	General information	55
10.1.1	Activate functional level	55
11	Parameterization	57
11.1	Date and time	57
11.2	Daylight saving time	57
11.3	Controller/parameter blocks	58
11.4	Setpoint values	62
11.4.1	Entered on the device	63
11.4.2	Entered using the setup program	63
12	Configuration	65
12.1	Analog selector	65
12.2	Digital selector	66
12.3	Basic settings	70
12.4	Digital inputs IN1 to 7	72
12.5	Analog inputs IN8, IN9, IN10, IN11	73
12.5.1	Alarms	76
12.6	Controller1, 2	77
12.6.1	Controller configuration	77
12.6.2	Controller inputs	80
12.6.3	Self-optimization controller	82
12.6.4	Control loop monitoring	87
12.6.5	Output level monitoring	90
12.6.6	Controller setpoint values	93
12.6.7	Ramp function	95
12.7	Digital outputs	97
12.8	Analog outputs	98
12.9	Limit value monitoring	100
12.9.1	Function and hysteresis	102
12.9.2	Hysteresis	103
12.9.3	Start-up alarm suppression	104
12.9.4	Acknowledging self-locking	104
12.9.5	Alarm	105
12.10	Screen	106
12.10.1	General configuration	106
12.10.2	Configuring the screen	107
12.10.3	Start screen and watermark	107
12.10.4	Operating loop	108
12.10.5	Recording colors	109
12.10.6	Color for controller screens 1, 2	110
12.10.7	Program controller screen	111
12.10.8	General screens 1, 2	112

12.11	Recording	113
12.11.1	Parameter	113
12.11.2	Analog channels	115
12.11.3	Digital channels	115
12.12	Program controller	116
12.12.1	Controller signals	118
12.12.2	Extended functions	119
12.12.3	Basic status	120
12.12.4	Manual operation mode	121
12.12.5	Behavior for out of range parameters	122
12.12.6	Weekly program	123
12.13	Timer or time switch	124
12.14	Digital controller signals	126
12.14.1	Alarms	128
12.15	Mathematics/logic	130
12.16	Flags/service	132
12.16.1	Flags	132
12.16.2	Service	133
12.17	External digital inputs	134
12.18	External analog inputs	135
12.18.1	Alarms	136
12.19	Serial interfaces	137
12.20	Modbus TCP	138
12.21	Relay module (accessories)	139
12.22	PROFIBUS DP (option)	140

13 Configuration – in setup program only119

13.1	Installing the setup program	119
13.1.1	Hardware	119
13.1.2	Software requirements	119
13.2	Starting the setup program	119
13.2.1	Establish the connection to the device	120
13.2.2	Setup data transfer on or from the external mass storage device	121
13.3	Country settings	122
13.4	User list	122
13.5	User level	123
13.6	E-mail	123
13.7	Web server	123
13.8	Modbus frames for reading	124
13.9	Modbus frames for writing	125
13.10	Customer-specific linearization	126
13.10.1	Grid points	126
13.10.2	Formula	127
13.11	Process screen	129
13.11.1	Process screen editor	130
13.11.2	Background	131

13.11.3	Signal types for process screens (overview)	133
13.11.4	General object features	134
13.11.5	Preview screen	135
13.11.6	Transfer process screen to device	136
14	Special functions	137
14.1	Calibrating the touchscreen	137
15	Online parameter	159
15.1	Fine adjustment	159
15.2	Ethernet (option)	161
15.3	Date and time	162
15.4	Screenshot	162
15.5	Deleting measurement data memory	162
15.6	Enabling of extra codes	163
15.7	Testing calibration	164
15.8	Various process values	164
16	Error and alarm messages	165
16.1	Error messages in float values and on the display	165
16.2	Display of error messages for binary values	165
17	Retrofitting optional boards	167
17.1	Safety information	167
17.2	Identifying the modules	167
17.3	Installing modules	168
17.3.1	Accessories	170

1.1 Safety information

General information

This manual contains information that must be observed in the interest of your own safety and to avoid damage to assets. This information is supported by symbols which are used in this manual as indicated.

Please read this manual before commissioning the device. Keep the manual in a place accessible to all users at all times.

If difficulties occur during commissioning please refrain from carrying out any manipulations that could jeopardize your warranty rights.

1.1.1 Warning symbols



DANGER!

This symbol indicates that **personal injury caused by electrical shock** may occur if the respective precautionary measures are not carried out.



WARNING!

This symbol in connection with the signal word indicates that personal injury may occur if the respective precautionary measures are not carried out.



CAUTION!

This symbol in connection with the signal word indicates that **damage to assets or data loss** will occur if the respective precautionary measures are not taken.



CAUTION!

This symbol indicates that **components could be destroyed** by electrostatic discharge (ESD = Electro Static Discharge) if the respective cautionary measures are not taken. Only use the ESD packages intended for this purpose to return device inserts, assembly groups, or assembly components.



READ DOCUMENTATION!

This symbol – placed on the device – indicates that the associated **device documentation has to be observed**. This is necessary to recognize the kind of the potential hazards as well as the measures to avoid them.

1.1.2 Note signs



NOTE!

This symbol refers to **important information** about the product, its handling, or additional use.



REFERENCE!

This symbol refers to **further information** in other sections, chapters, or manuals.

1 Introduction



FURTHER INFORMATION!

This symbol is used in the tables and refers to **further information** in connection with the table.



DISPOSAL!

This device and the batteries (if installed) must not be disposed in the garbage can after use! Please ensure that they are disposed properly and in an **environmentally friendly manner**.

1.1.3 Representation

Menu structure

The > symbol between words indicates a menu structure and enables the parameters to be quickly detected in the configuration level or for navigation in the setup program, such as the software version of the devices, for example:

DEVICE MENU > GENERAL > VERSION > SW VERSION

Active input

The device has no buttons and is operated using a finger or a pen.

The following instructions will therefore make references to **"touching"** and the images displayed will show a hand operating the device.

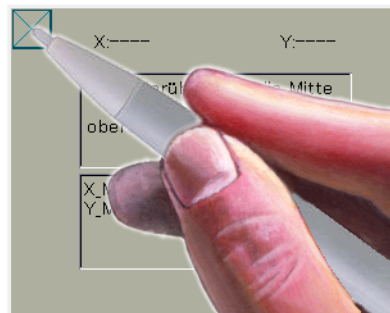
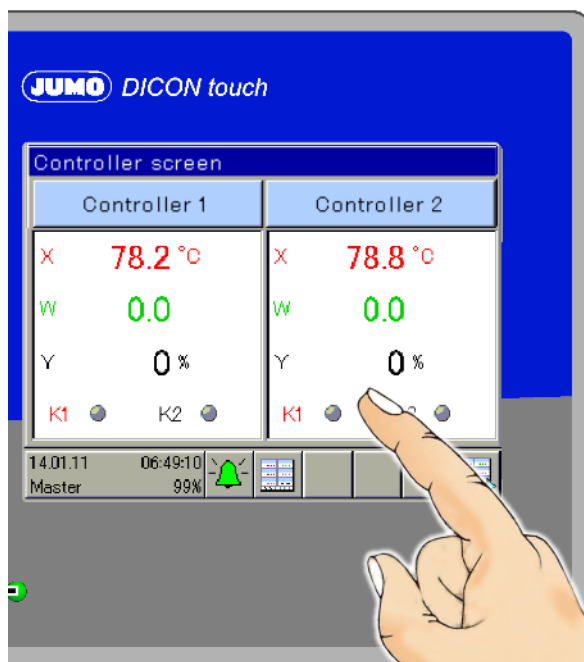

1.2 Description

The DICON touch is a two-channel universal process and program controller that displays information on a vibrant screen. The device is easy to operate via a touchscreen.

Both control channels use the tried-and-tested JUMO control algorithm with two possible optimization options. These enable a simple and highly-accurate startup. It also enables multiple zone control, cascade control, or other complex control tasks.

The block diagram below illustrates the various different hardware options offered by the modular hardware concept. Four analog universal inputs and up to eight external inputs can record a variety of physical measured values with high precision. The actuators can be controlled directly in the device with either an analog or digital setup. These can be expanded further through external digital outputs. Interfaces such as Modbus (master/slave), PROFIBUS, or Ethernet with Web server can be used for the communication with higher-order systems.

To ensure secure process operation, the device has a password-protected user administration with individual assignment of rights for different levels or control commands. Screen masks for controllers, program generators, recording, and for overview screens are ready-made and available. An individual process screen can be created using the configuration software. Using the extra-code recording function, important analog and digital process values can be saved so that they are tamper-proof, so that they can be graphically visualized, and so that they can be exported via interface or USB stick in a tamper-proof fashion to the PC.

The configuration software ensures that the process controller can be easily programmed, that math or logical coherences can be described, and that customer-specific linearizations can be created. In addition, tools for simulating external signals or control paths are included. These tools can also record for the duration of the startup.

A comprehensive alarm and limit-value concept as well as a flexible digital signal administration complete the "all-in-one" device.

1 Introduction

1.3 Block diagram

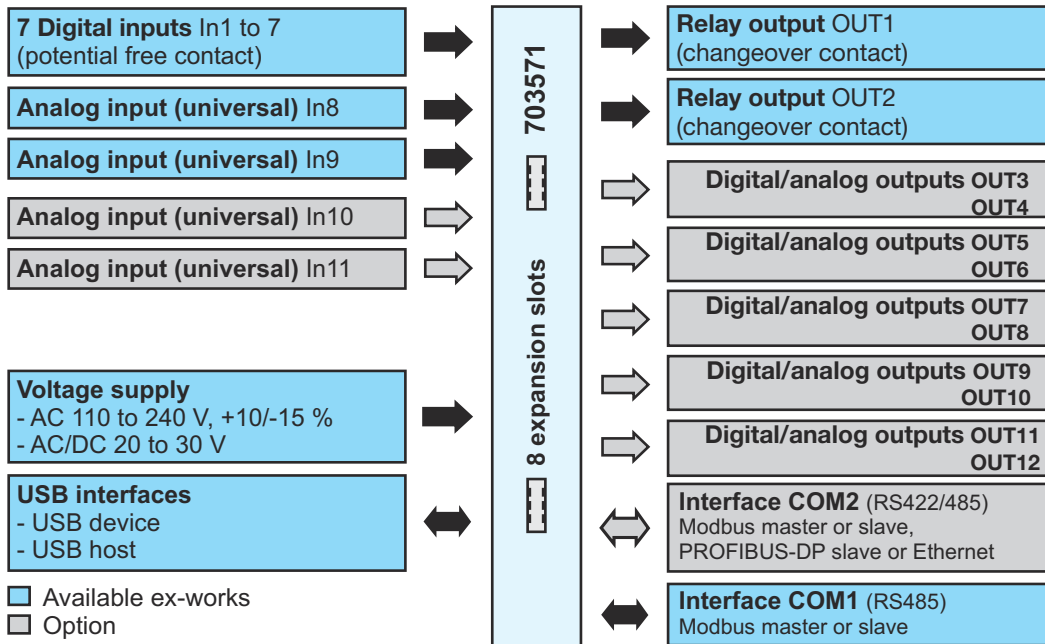

2 Identifying the device version

2 Identifying the device version

2.1 Order details

(1) Basic type	
703571	JUMO DICON touch - two-channel process and program controller with RS485 interface
(2) Version	
8	Standard with factory settings
9	Customer-specific configuration (specifications in plain text)
(3) National language of display texts	
01	German
02	English
03	French
(4) Input 3 (IN10)	
00	Not used
10	Analog input (universal)
(5) Input 4 (IN11)	
00	Not used
10	Analog input (universal)
(6) Output 3 (OUT3/4)	
00	None
11	1 relay (changeover contact)
12	2 relays (N/O contact)
13	1 solid-state relay 230 V, 1 A
14	1 logic output 0/22 V
15	2 logic outputs 0/12 V, 20 mA
16	1 analog output
17	2 PhotoMOS® relays ¹
(7) Output 4 (OUT5/6)	
00	None
11	1 relay (changeover contact)
12	2 relays (N/O contact)
13	1 solid-state relay 230 V, 1 A
14	1 logic output 0/22 V
15	2 logic outputs 0/12 V, 20 mA
16	1 analog output
17	2 PhotoMOS® relays
(8) Output 5 (OUT7/8)	
00	None
11	1 relay (changeover contact)
12	2 relays (N/O contact)

2 Identifying the device version

13	1 solid-state relay 230 V, 1 A
14	1 logic output 0/22 V
15	2 logic outputs 0/12 V, 20 mA
16	1 analog output
17	2 PhotoMOS® relays
(9) Output 6 (OUT9/10)	
00	None
11	1 relay (changeover contact)
12	2 relays (N/O contact)
13	1 solid-state relay 230 V, 1 A
14	1 logic output 0/22 V
15	2 logic outputs 0/12 V, 20 mA
16	1 analog output
17	2 PhotoMOS® relays
(10) Output 7 (OUT11/12)	
00	None
11	1 relay (changeover contact)
12	2 relays (N/O contact)
13	1 solid-state relay 230 V, 1 A
14	1 logic output 0/22 V
15	2 logic outputs 0/12 V, 20 mA
16	1 analog output
17	2 PhotoMOS® relays
(11) Supply voltage	
23	AC 110 to 240 V +10/-15 %, 48 to 63 Hz
25	AC/DC 20 to 30 V, 48 to 63 Hz
(12) COM2 interface	
00	Not used
08	Ethernet
54	RS422/485 Modbus RTU
64	PROFIBUS-DP
(13) DIN-tested	
000	Without approval
056	With DIN approval
(14) GL-tested	
000	Without approval
062	With GL approval
(15) Extra codes	
000	Without extra code
213	Recording function

2 Identifying the device version

214	Math and logic module
223	Program controller

¹ PhotoMOS is a registered trademark of Panasonic Corporation

(1) / (2) - (3) - (4) (5) - (6) (7) (8) (9) (10) - (11) - (12) / (13) , (14) , (15)
)

Order code / - - - - - / , , ...¹

Order example 703571 / X - X - X X - X X X X X - X - X / X , X , X

¹ List extra codes in sequence, separated by commas.

2.2 Scope of delivery





- 1 controller in the ordered version
- 1 Operating Manual B 703571.0
- 1 panel seal 4 retaining elements for panel installation

2.3 General accessories

Article	Part no.
Program editor/startup	00607139
Setup/program editor	00606496
PCA3000/PCC JUMO software package 709701/709702	00431884
USB cable A-connector mini B-connector 3 m	00506252

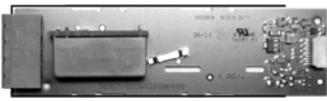
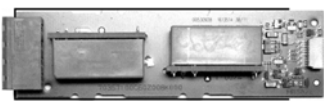
2 Identifying the device version

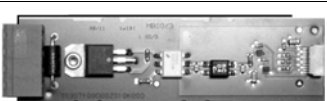
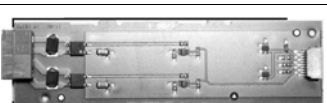
2.4 Accessories

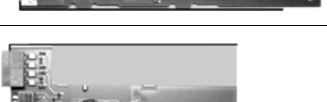
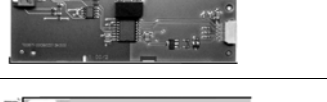
Article		Part no.
Modules for expansion slots:		
1 analog input (universal)		00581159
1 relay output (changeover contact)		00581160
2 relay outputs (N/O contact)		00581162
1 logic output DC 0/22 V max. 30 mA		00581165
2 logic outputs DC 0/12 V max. 20 mA		00581168
1 solid state relay AC 230 V, 1 A		00581164
2 PhotoMOS® relays ¹ DC 50 V, max. 200 mA, AC 35 V, max. 200 mA		00581171
1 analog output (universal)		00581169
Ethernet interface		00581174
Serial interface RS422/RS485		00581172
PROFIBUS-DP interface		00581173

¹ PhotoMOS is a registered trademark of Panasonic Corporation

2 Identifying the device version

2.5 Nameplate

Position

The nameplate is affixed to the case.

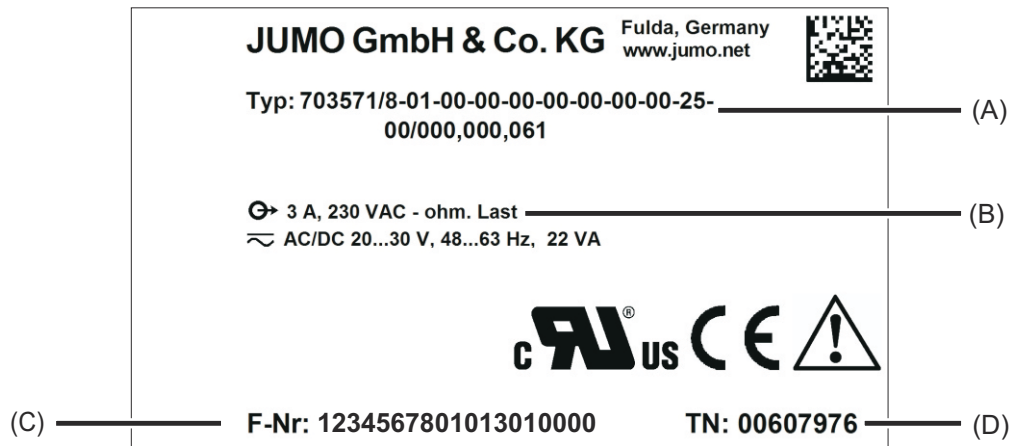

Contents

The nameplates contain important information. This includes:

Description	Designation on the nameplate
Device type (A)	Type
Voltage supply, power consumption (B)	
Fabrication number (C)	F-No.
Part no. (D)	TN

Device type

Compare the specifications on the nameplate with the order.

Identify the supplied device version using the order details (order code).

Part no. (PN)

The part no. clearly identifies an article in the catalog. It is important for communication between the customer and the sales department.

Fabrication number (F-No.:

Among other things, the fabrication number contains the date of production (year/week).

Example: F-No. = 1234567801013010000

The figures in question are in positions 12, 13, 14, and 15 (from the left).

The device was therefore produced in the 1st calendar week of 2013.

Identifying the optional modules

The device type also contains information about optional default modules, as in the following example of the Ethernet interface (Figure 08):

703571/8-01-00-00-00-00-00-00-25-08... (see type key)

Further information on identifying optional modules is included in this chapter:

⇒ B 703571.0 - Chapter 9.2 "Slots", page 51

3.1 Mounting site and climatic conditions

The mounting site should be free from vibration, dust and corrosive media. Install controllers as far away as possible from sources of electromagnetic fields, such as those created by frequency converters or high-voltage ignition transformers. Conditions at the mounting site must correspond to the following environmental influences:

3.1.1 Environmental influences

Ambient/storage temperature range	-5 to +55 °C/-30 to +70 °C
Resistance to climatic conditions	Humidity 3K3 (DIN EN 60721-3-3) with extended temperature range, rel. humidity ≤ 95 % mid-year without condensation

3.1.2 Case

Case type	Plastic front frame with metal case barrel
Front frame dimensions	96 mm × 96 mm
Panel cut-out	92 ^{+0.8} mm × 92 ^{+0.8} mm according to DIN IEC 61554
Close mounting	Spacing between the panel cut-outs, min. 35 mm horizontally and min. 80 mm vertically
Panel thickness	Max. 5 mm
Depth behind panel	Max. 130 mm
Mounting	Four mounting brackets
Operating position (including the viewing angle of the TFT color screen)	Any Horizontal ±65°, vertical +40 to -65°
Protection type	Front IP66, rear IP20, according to DIN EN 60529
Weight (fully fitted)	approx. 1000 g

3 Mounting

3.1.3 Electrical data

Voltage supply Connection Voltage	At the back via screw terminals AC/DC 20 ... 30 V, 48 to 63 Hz or AC 110 to 240 V +10/-15 %, 48 to 63 Hz	
Power consumption	At voltage supply 230 V: max. 38.1 VA/11.5 W At voltage supply 24 V: max. 21.9 VA/11.5 W	
Inputs and outputs Connection Conductor cross section	At the back via screw terminals Max. 2.5 mm ² , wire or strand with end sleeve	
Electrical safety	According to DIN EN 61010-1 Overvoltage category III, pollution degree 2	
Electromagnetic compatibility Interference emission Interference immunity	According to DIN EN 61326-1 Class A - For industrial applications only Industrial requirements	
Memory data recorder	Memory cycle	Recording interval
When recording: 4 analog signals 3 digital signals	1 s	approx. 44 days
	3 s	approx. 220 days
	10 s	approx. 441 days
	60 s	approx. 2646 days (7 years, 91 days)

3.2 Dimensions

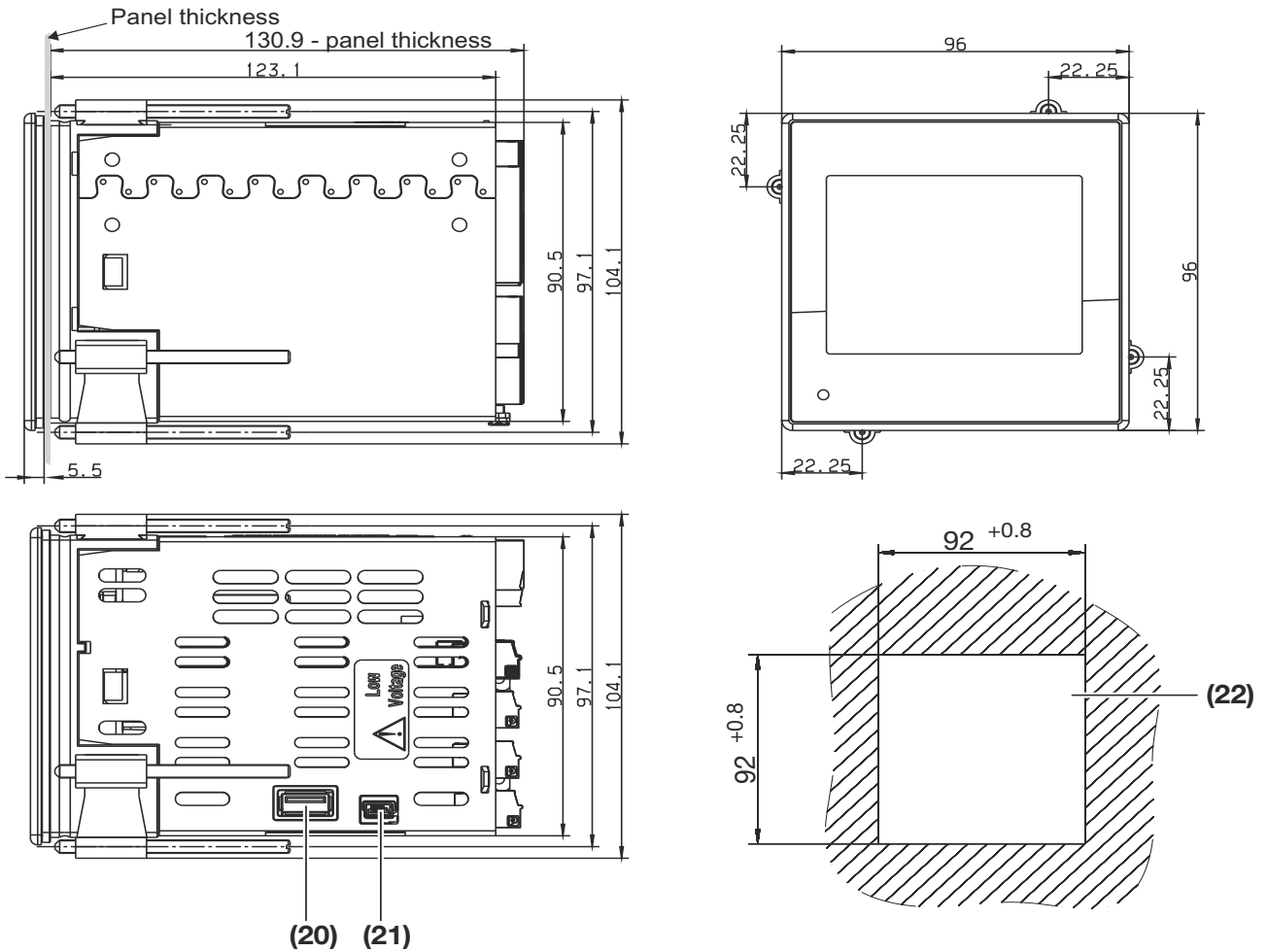

(20) USB host interface

(21) USB device interface for setup

(22) Panel cut-out

3.3 Close mounting

If several devices are mounted on a switch board above or next to each other, the panel cut-outs must be positioned 35 mm horizontally and at least 80 mm vertically away from each other.

3 Mounting

3.4 Insertion in panel cut-out

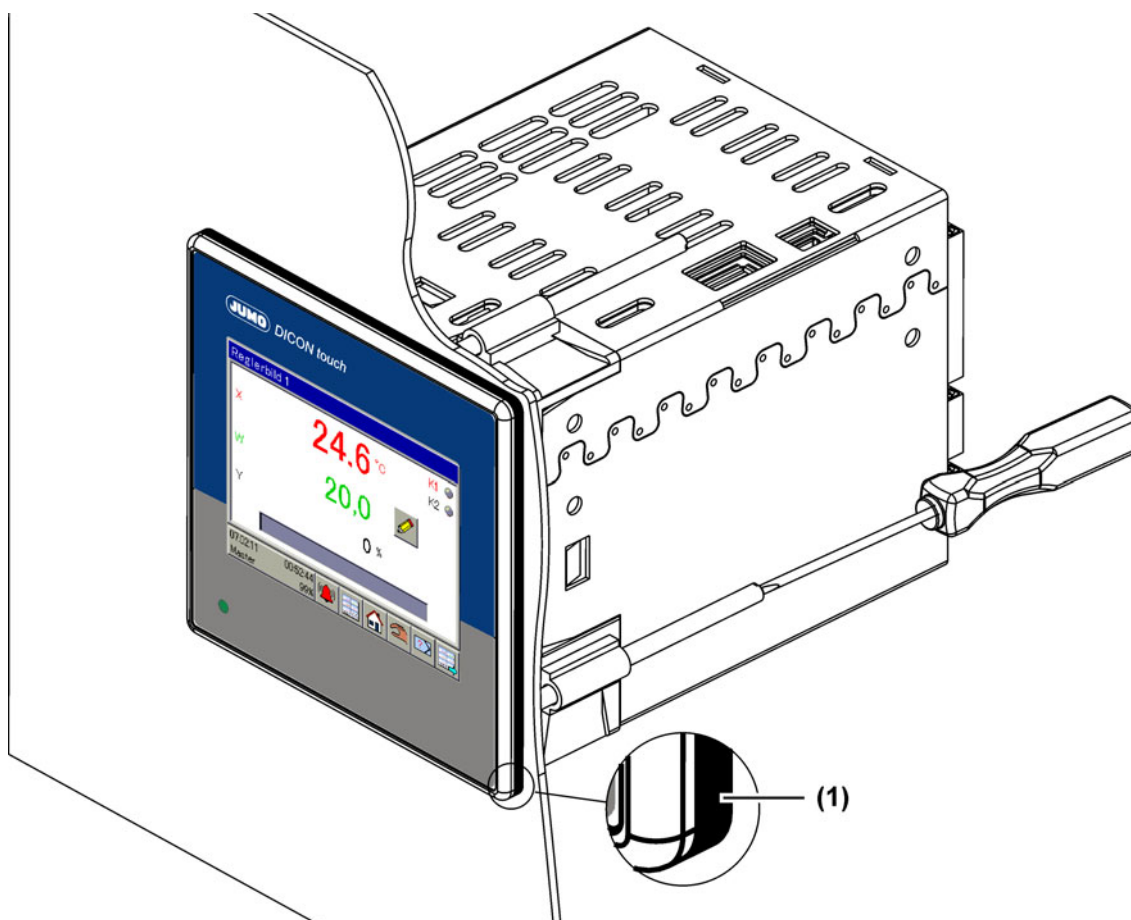

Step	Activity
1	Affix delivered panel seal (1) on the device from the rear
2	Insert the device into the panel cut-out from the front and ensure the panel seal is correctly positioned so that no water or dirt can penetrate the case.
3	From the panel rear, slide the mounting brackets into the guides on the sides of the case. In doing so, the flat faces of the mounting brackets must make contact with the case.
4	Place the mounting brackets against the panel rear and tighten evenly with a screwdriver until the controller housing is firmly positioned in the panel cut-out.

3.5 Care and treatment of the front cover

The front plate can be cleaned with commercial detergents and cleaning agents.



NOTE!

The resistive touchscreen cover reacts to finger pressure or can be operated using commercially available pens with a rounded plastic tip.

**CAUTION!**

Sharp tools can scratch and damage the cover.

The front plate is not resistant to corrosive acids or lyes, abrasives, or cleaning with high-pressure cleaners.

Do not use sharp objects near the device.

3 Mounting

4.1 Installation notes

**CAUTION!**

The delivery status of the device at the first startup does not necessarily correspond to the intended application (for example, Controller 2 inactive).

This may result in undefined plant behavior.

Therefore, where possible during startup, no actuators should be connected and load current circuits should be isolated. The plant installer is essentially responsible for the startup process.

4.1.1 Cables, shielding, and grounding

When selecting the electrical wiring material as well as when installing and connecting the controller electrically, comply with the requirements of DIN VDE 0100 "Low-voltage electrical installations" and the applicable country-specific regulations (for example, based on IEC 60364).

- Where possible, route input, output, and supply cables separately and not parallel to one another.
- Only use shielded and twisted probe and interface cables and where possible, route them at a distance from components or lines that are live.
- For temperature probes, ground the shielding on one side in the control cabinet.
- Do not perform loophroughs on the grounding cables, but route the cables individually to a shared grounding point in the control cabinet; in doing so, ensure that the cables are as short as possible.
- Ensure potential equalizer is correctly routed.

4.1.2 Electrical safety

- The primary fuse protection for the voltage supply should not exceed a value of 20 A (passive) and should not be less than 2 A.
- In order to prevent the destruction of the relay or solid state relay outputs in the event of an external short circuit in the load circuit, the load circuit should be fused to the maximum admissible output current.
- In addition to a faulty installation, incorrectly set values on the controller could also impair the correct function of the following process. Therefore, ensure that safety devices independent of the controller (for example, overpressure valves or temperature limiters/monitors) are available and that it is only possible for qualified personnel to define settings. Please observe the corresponding safety regulations in this context.
- Since not all existing control paths can be controlled with the setting function, the stability of the actual value reached should be monitored.

4.1.3 Intended use, misuse

- The controller is intended for use in the industrial sector.

**WARNING!**

The controller is not suitable for installation in areas with an explosion hazard

There is the risk of an explosion.

The device must only be used outside of areas with an explosion hazard.

4 Electrical connection

4.2 Galvanic isolation

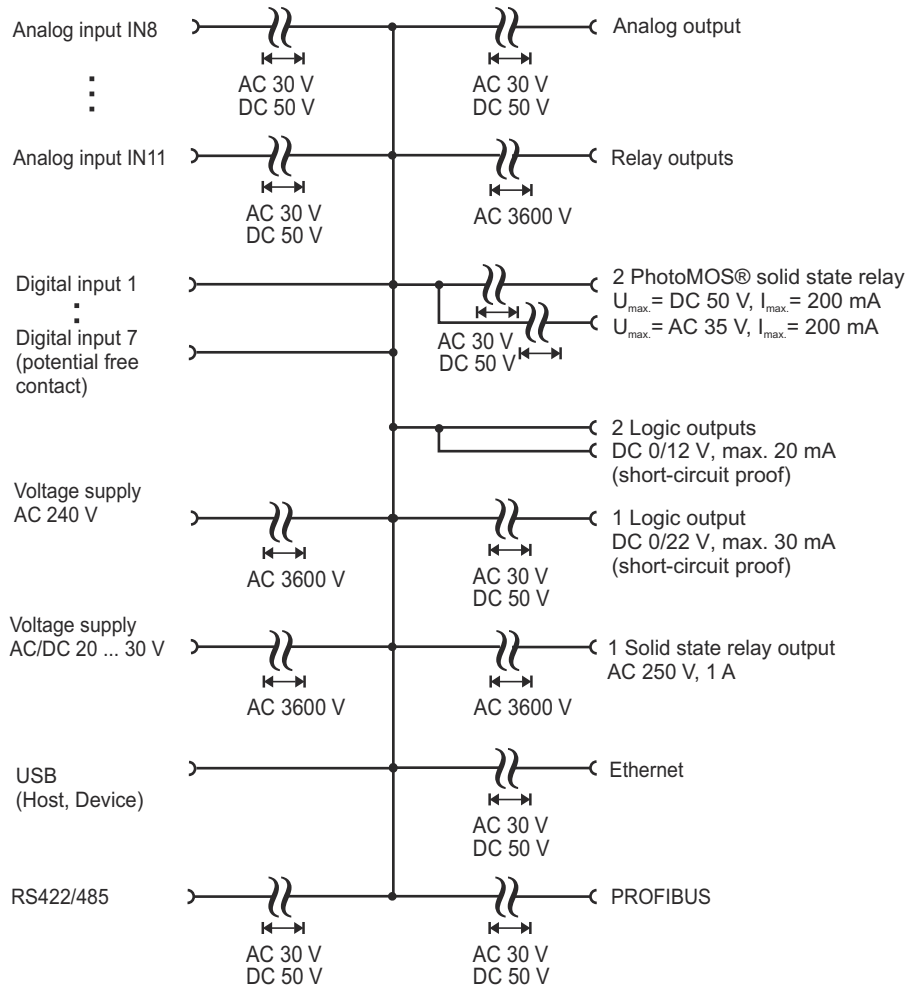

4.3 Connection diagram



DANGER!

Works involving dangerous electrical voltage (230 V) are performed here. There is a risk of electric shock.

Switch off all voltage circuits before routing. The electrical connection must only be carried out by qualified personnel.

4.3.1 Connection elements

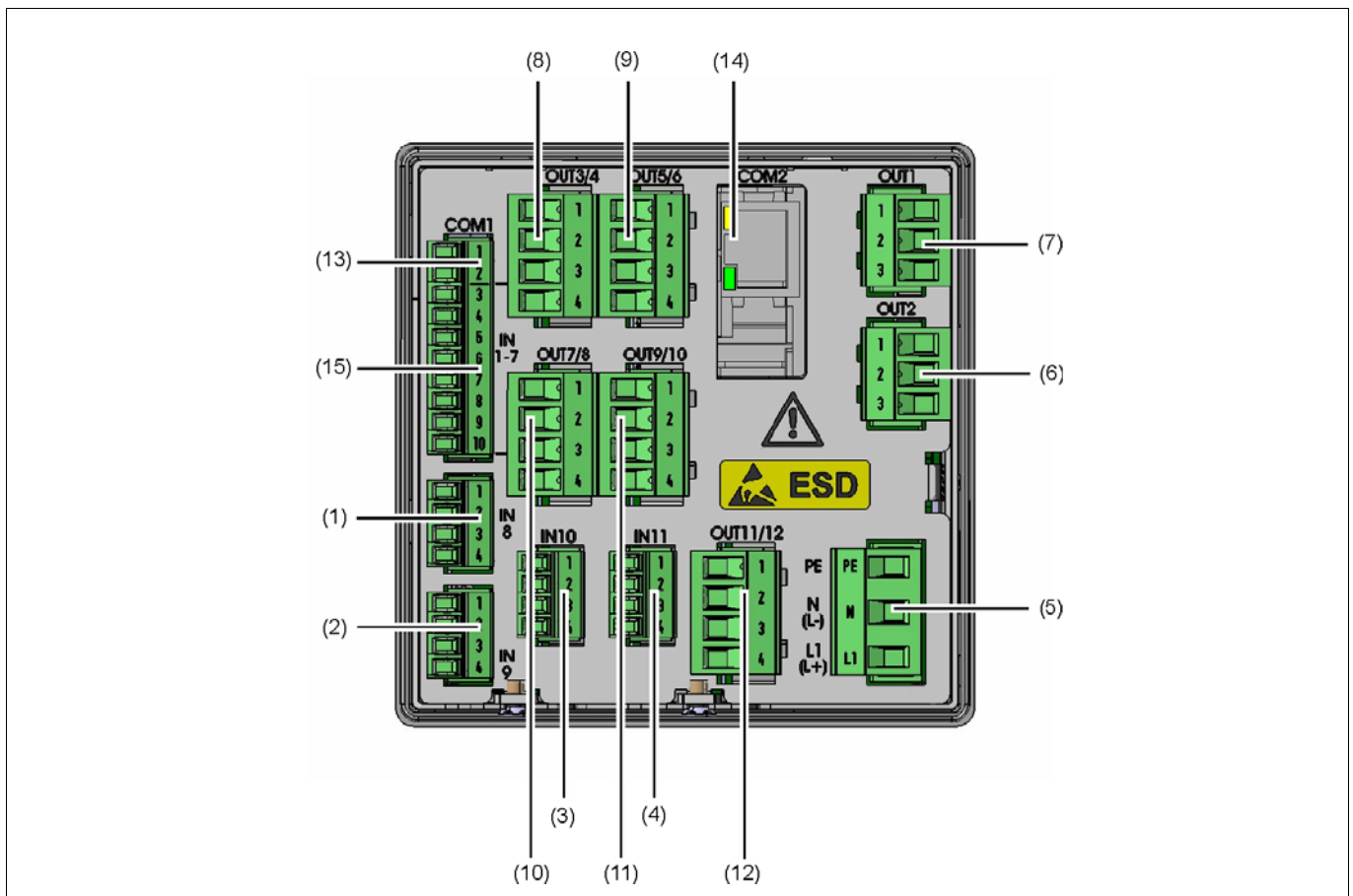



- | | |
|--|--|
| (1) Analog input IN8 | (2) Analog input IN9 |
| (3) Expansion slot for analog input IN10 | (4) Expansion slot for analog input IN11 |
| (5) Voltage supply
AC 240 V +10/-15 %, 48 to 63 Hz, max. 38.1 VA
AC/DC 20 to 30 V, 48 to 63 Hz,
max. 21.9 VA / 11.5 W | (6) Relay output OUT2 |
| (7) Relay output OUT1 | (8) Expansion slot for outputs OUT3/4 |
| (9) Expansion slot for outputs OUT5/6 | (10) Expansion slot for outputs OUT7/8 |
| (11) Expansion slot for outputs OUT9/10 | (12) Expansion slot for outputs OUT11/12 |
| (13) COM1 interface RS485 | (14) Expansion slot for COM2 interface |
| (15) Digital inputs IN1 to 7 | |

4 Electrical connection

4.3.2 Analog inputs

Input IN8, IN9 as standard

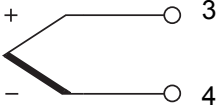
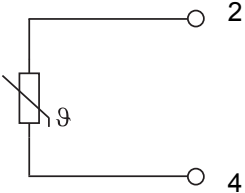
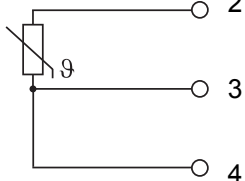
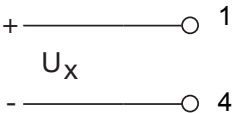
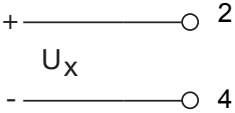
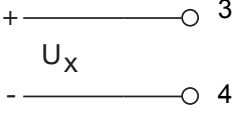
Two analog inputs can be added to input (IN10), (IN11) optional boards

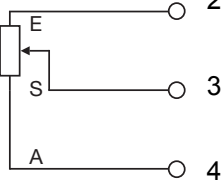
Connection	(Connection element) Input	Symbol and terminal designation
Thermocouple	(1) IN8 (2) IN9 (3) IN10 (4) IN11	
RTD temperature probe Two-wire circuit		
RTD temperature probe Three-wire circuit		
Voltage DC 0(2) to 10 V		
Voltage DC 0 to 1 V		
Voltage DC 0 to 100 mV		
Current DC 0(4) to 20 mA		
Resistance transmitter A = Start E = End S = Slider		

4.3.3 Analog outputs

One analog output can be added to output OUT 3/4 to 11/12 using optional boards

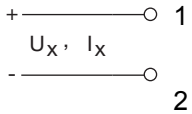
Connection	(Connection element) Input	Symbol and terminal designation
One analog output DC 0/2 to 10 V or DC 0/ 4 to 20 mA (configurable)	(8) OUT3/4 (9) OUT5/6 (10) OUT7/8 (11) OUT9/10 (12) OUT11/12	

4.3.4 Digital inputs

Input IN1 to 7 as standard (cannot be extended)

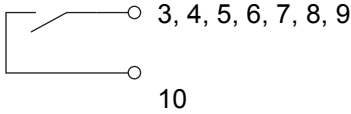
Connection	(Connection element) Input	Symbol and terminal designation
Digital input, potential-free contact as standard	(15) IN1 to 7	

4.3.5 Digital outputs

OUT1 and OUT2 as standard

The controller is fitted with two relay outputs (changeover contacts) as standard.

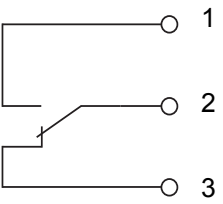
Connection	(Connection element) Output	Symbol and terminal designation
Relay output (changeover contact)	(6) OUT2 (7) OUT1	

4 Electrical connection

Outputs OUT 3/4 to 11/12 can be extended using the following optional boards

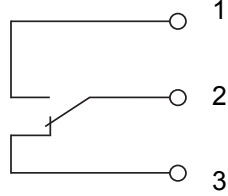
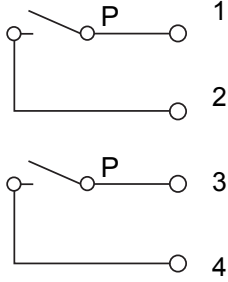
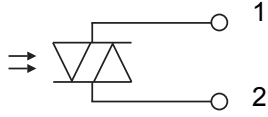
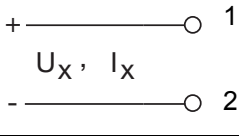
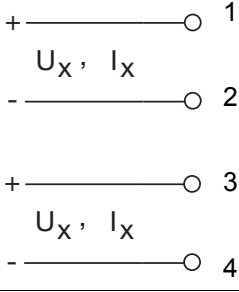
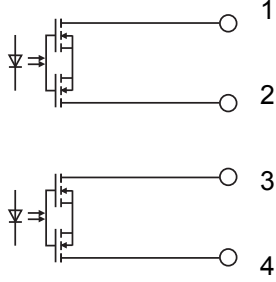
Connection	(Connection element) Output	Symbol and terminal designation
1 relay output (changeover contact)	(8) OUT3/4 (9) OUT5/6 (10) OUT7/8 (11) OUT9/10 (12) OUT11/12	
2 relay outputs (N/O contact) ¹		
1 solid state relay AC 230 V, 1 A		
1 logic output DC 0/22 V max. 30 mA (short-circuit proof)		
2 logic outputs DC 0/12 V max. 20 mA (short-circuit proof, not galvanically isolated from each other)		
2 PhotoMOS® relays ² max. DC 50 V, 200 mA max. AC 35 V, 200 mA (galvanically isolated)		

4 Electrical connection

Connection	(Connection element) Output	Symbol and terminal designation
Two solid state relays AC 230 V, 1 A (for controlling the left and right-hand motor actuators, galvanically isolated)		

¹ Combining a mains voltage circuit with a protective low-voltage circuit on a 2-way normally open contact option is not admissible.

² PhotoMOS is a registered trademark of Panasonic Corporation.

4.3.6 Digital outputs

Standard

Two relay outputs (changeover contact) Switching capacity Contact life	3 A at AC 250 V, resistive load 150,000 operations at rated load
--	---

Per optional board

One relay output (changeover contact) Switching capacity Contact life	3 A at AC 250 V resistive load 150,000 operations at rated load
Two relay outputs (N/O contact) ¹ Switching capacity Contact life	3 A at AC 250 V, resistive load 150,000 operations at rated load
One solid state relay Switching capacity Protection circuitry	1 A at AC 230 V, resistive load Varistor
1 logic output (voltage supply for transmitter)	DC 0/22 V max. 30 mA (short-circuit proof)
2 logic outputs	DC 0/12 V max. 20 mA (short-circuit proof, not galvanically isolated)
2 PhotoMOS® relays ²	DC 50 V, max. 200 mA, (galvanically isolated from each other, not short-circuit proof) AC 35 V, max. 200 mA, (galvanically isolated from each other, not short-circuit proof)

¹ Combining a mains voltage circuit with a protective low-voltage circuit on the "dual normally open contact" option is not permissible.

² PhotoMOS is a registered trademark of Panasonic Corporation.

4 Electrical connection

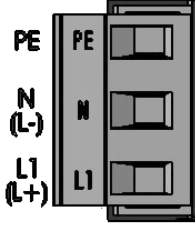

4.3.7 Voltage supply (according to nameplate)

AC 230V (DC 24V)

Connection	(Connection element)	Symbol and terminal designation
Protection conductor	PE	
Neutral conductor	N (L-)	
Line conductor	L1(L+)	

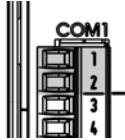

4.3.8 Interfaces

USB device, USB host and COM1 interfaces as standard

Connection	(Connection element)	Symbol and terminal designation
USB device interface (setup)	(21)	
USB host (firmware update)	(20)	
COM1 serial interface RS485 (galvanically isolated)	(13)	 <div style="display: inline-block; vertical-align: middle; margin-left: 20px;"> <p>1 TxD+/RxD+ Transmission/ received data +</p> <p>2 TxD-/RxD- Transmission/ received data -</p> </div>

4 Electrical connection

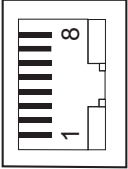
COM2 interface can be expanded using optional boards

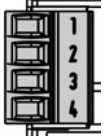
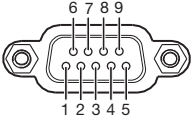
Connection	(Connection element)	Symbol and terminal designation
Ethernet	(14)	 <ul style="list-style-type: none"> 1 TX+ Transmission data + 2 TX- Transmission data - 3 RX+ Received data + 6 RX- Received data -
Serial interface RS422 (galvanically isolated)		 <ul style="list-style-type: none"> 1 RxD+ Received data + 2 RxD- Received data - 3 TxD+ Transmission data + 4 TxD- Transmission data -
Serial interface RS485 (galvanically isolated)		 <ul style="list-style-type: none"> 3 TxD+/RxD+ Transmission/ received data + 4 TxD-/RxD- Transmission/ received data -
PROFIBUS-DP		 <ul style="list-style-type: none"> 3 RxD/TxD-P (B) Transmission/ received data + 5 DGND Ground 6 VP (+5 V) Voltage supply 8 RxD/TxD-N (A) Transmission/ received data -

4 Electrical connection

5.1 Display and operating concept

The DICON touch is operated via a resistive touchscreen and also reacts to finger pressure. Commercially available pens with plastic tips can also be used.

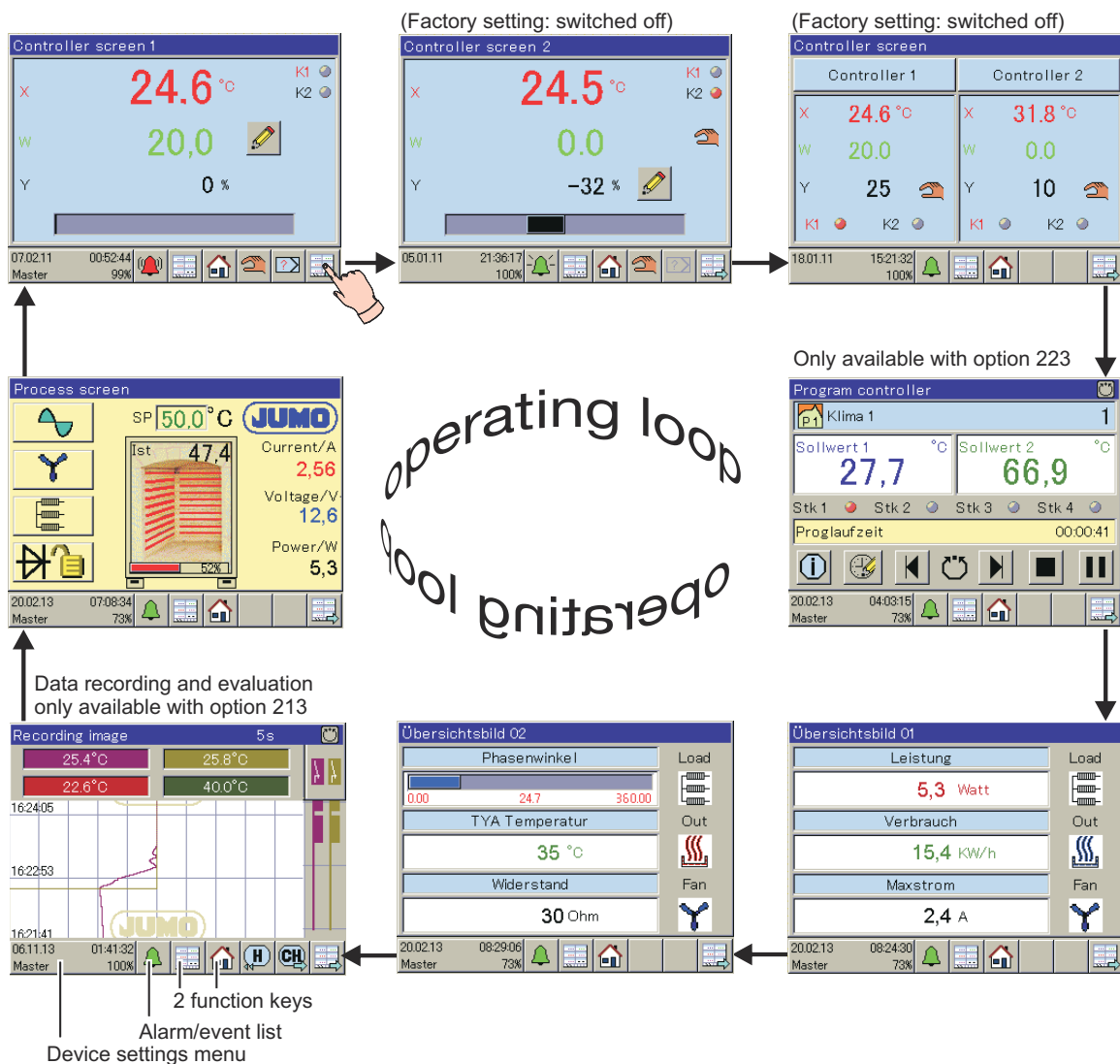
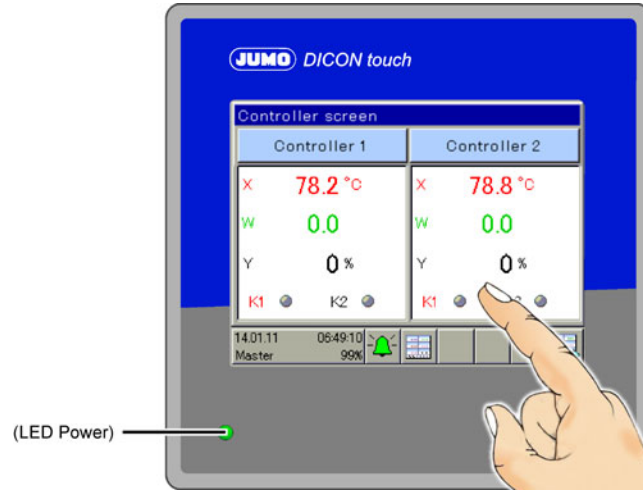

5 Operation

5.2 Device menu

All the functions in the device menu are described in the following sections of the B703571.0de operating manual.

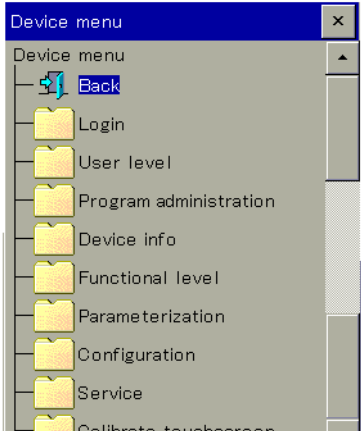
	Chapter 6 "Login", page 43
	B 703571.0 - Chapter 7 "User level (Log-In)", page 45
	Chapter 8 "Program administration", page 47
	B 703571.0 - Chapter 10 "Functional level", page 55
	B 703571.0 - Chapter 11 "Parameterization", page 57
	B 703571.0 - Chapter 12 "Configuration", page 65
	Calibrating the touchscreen: Chapter 14 "Special functions", page 137

5.3 Alarm and event list

In these lists, alarms and events appear that are partly confirmed. Additional entries can be configured to appear in the lists.

- ⇒ B 703571.0 - Chapter 12.9.5 "Alarm", page 105
- ⇒ B 703571.0 - Chapter 12.5.1 "Alarms", page 76

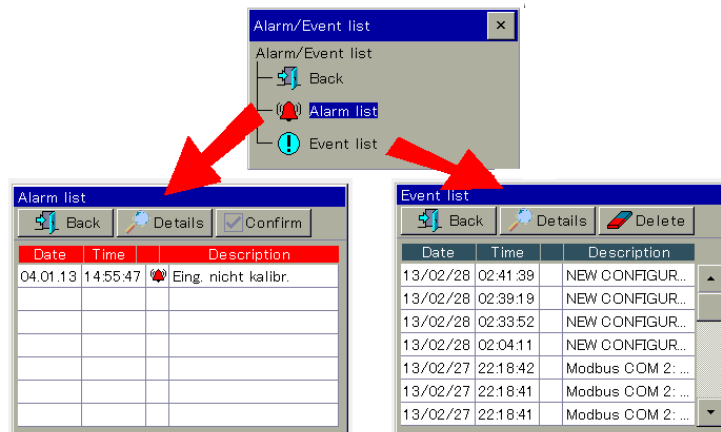

5.4 Function buttons, history and channel changeover

Both these function buttons are set and configurable by default at "Operating level" and "Home" (back to Main view).

- ⇒ B 703571.0 - Chapter 12.10.1 "General configuration", page 106
- The "History"(H) and "Channel changeover"(Ch) buttons enable navigation in the recorder image and change their meaning according to the dialog.
- ⇒ Chapter 5.5.4 "Recording image", page 40

5.5 Images in the operating loop

Start screen

After switch-on, the globe appears until the device software is started up.



Then Controller screen 1 appears (default setting).

Using the icon in the bottom right-hand corner, all the images defined in the operating loop can be called up one after another.

⇒ For the screen settings see B 703571.0 - Chapter 12.10 "Screen", page 106

⇒ To view the images displayed see B 703571.0 - Chapter 12.10.4 "Operating loop", page 108

5.5.1 Controller screen 1, Controller screen 2 and Controller overview

You can change the color of these screens in the setup program.

The basic structure cannot be changed however.

default

Fixed-setpoint controller and Controller 1 are set up.

In order to function properly, the controller requires an actual value, a setpoint value, and an output to influence the actual value (for example, a heat source via a relay as a two-state controller). Self-optimization can only detect new parameters using a closed control loop.

⇒ Chapter 12.6.3 "Self-optimization controller", page 82

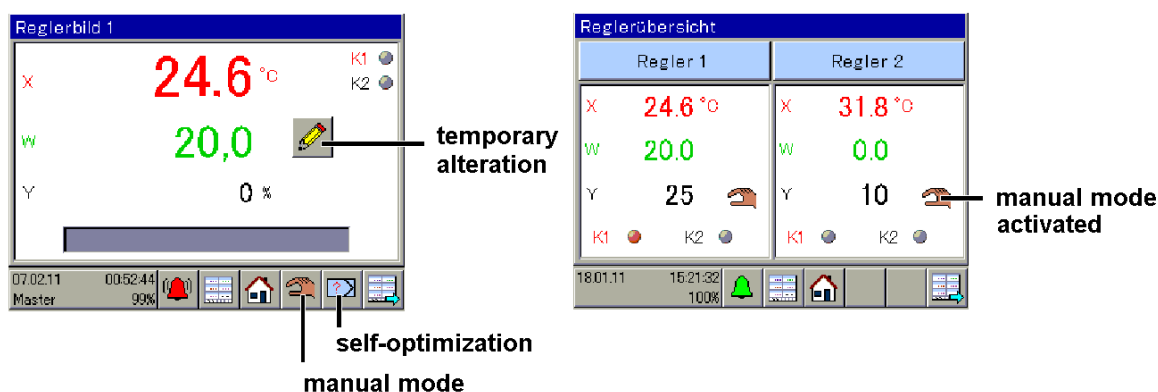

If lines or arrows appear, check the configuration or the connection.

⇒ Chapter 16 "Error and alarm messages", page 165

Enter setpoint values on the device for the fixed-setpoint controller

⇒ Chapter 11.4 "Setpoint values", page 62



Enter setpoint values for the fixed-setpoint controller with the setup program

⇒ Chapter 11.4 "Setpoint values", page 62

5 Operation

Start manual mode

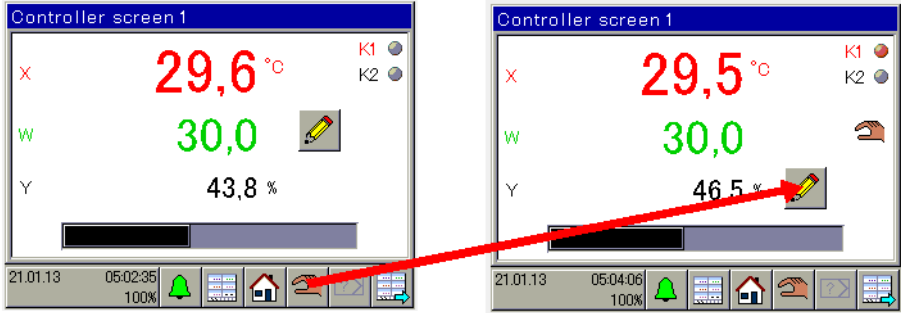
In manual mode, the controller is fixed at a particular output level. First of all, the screens show the active controller, where the output is at approx. 40 %.

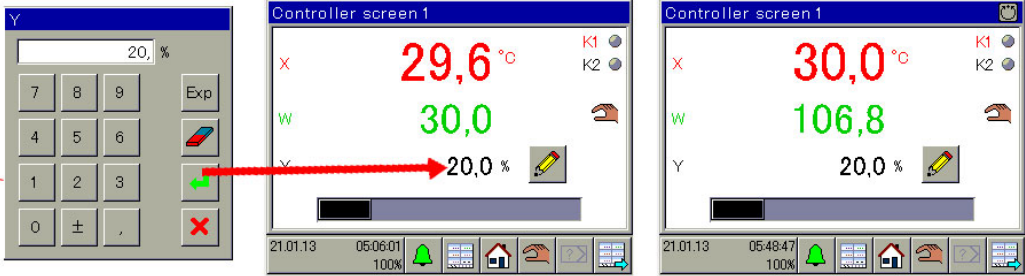
Step	Activity
1	<p>Touch the hand symbol (pencil appears at output level display)</p> 
2	<p>Touch the pencil, enter the manual output level and confirm (green arrow)</p> 
3	<p>The controller operation is interrupted and Controller 1 is now working with a fixed output level of 20 % (the hand symbol appears next to the green setpoint value). You can view the difference between the fixed-setpoint controller and the program controller at the automatic operation icon in the top right-hand corner. The green setpoint value continues, as programmed.</p> 

➔ You can now manually influence the output level (by hand)

Exit manual mode

By touching the screen below the hand, you can exit manual mode and return to normal controller operation.

Self-optimization

⇒ B 703571.0- Chapter 12.6.3 "Self-optimization controller", page 82

5.5.2 Program controller



NOTE!

This screenshot is not available by default and only appears if the extra code for the program controller is enabled and configured.

⇒ Chapter 2.1 "Order details", page 14

default

There are no programs available. The following options are available for ordering a program:

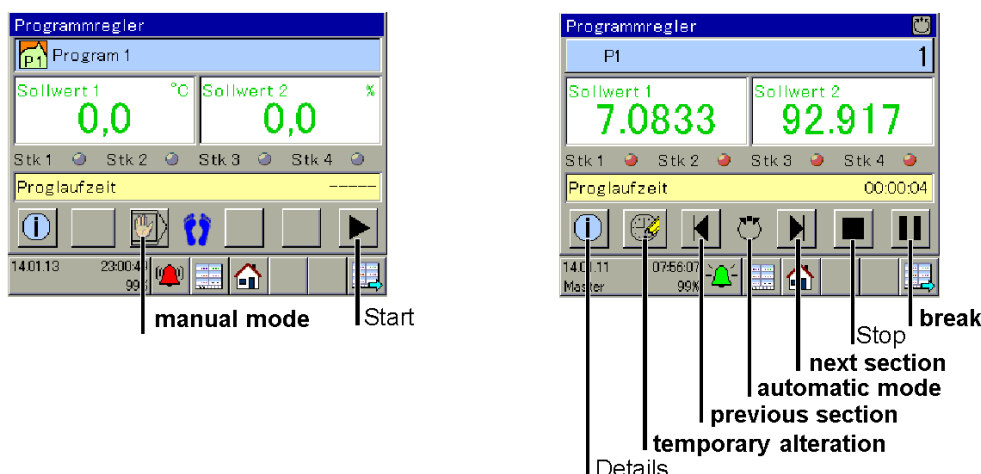

Enter setpoint curves on the device

⇒ Chapter 8.1.1 "On the device", page 47

Enter setpoint curves using the setup program

⇒ Chapter 8.1.2 "About the setup program", page 48

Start, Stop

The black arrow starts an available program. A request appears asking which program should be started and the programmed setpoint curves are then synchronized for both controller channels. The symbol for automatic operation appears in the center. Touching the black rectangle stops the program, adopting the conditions prior to the program starting.

Pause

Pauses the time base of a program in operation, whereby the current setpoint values and the conditions of the control contacts are maintained. Touching the pause button again resumes program operation.

Next section, previous section

The program in operation jumps to the next or previous section.

Temporary alteration

Allow one-time changes to the setpoint values for a program without storing it permanently in the program table. When you next run the program, the original setpoint values will be reactivated.

Start/stop manual mode (for program controller)

Manual mode is performed exactly as for a fixed-setpoint controller.

⇒ Chapter 5.5.1 "Controller screen 1, Controller screen 2 and Controller overview", page 37

Self-optimization

⇒ B 703571.0- Chapter 12.6.3 "Self-optimization controller", page 82

5 Operation

5.5.3 General screen 1.2

default

Two general screens are available that do not contain any variables.

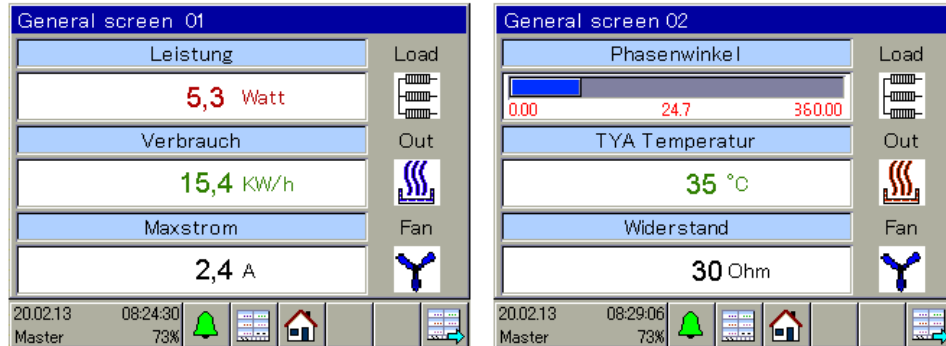

The variables displayed can be configured.

⇒ B 703571.0- Chapter 12.10.8 "General screens 1, 2", page 112

5.5.4 Recording image

default

Here the device is displaying up to four analog and three digital channels, like a line recorder. Extra code 213 is required for data to be recorded and evaluated.

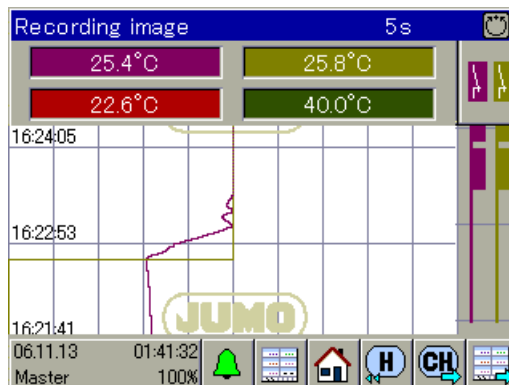

You can view historical data (from previous recordings) with the H button and switch channels with the CH button. If the channels displayed are configured, the screen must still be active for the operating loop display.

⇒ B 703571.0 - Chapter 12.11 "Recording", page 113

5.5.5 Process screen

default

This screen can be freely configured and is empty by default. A background image of your plant can be stored and animated with all the process values for the device.

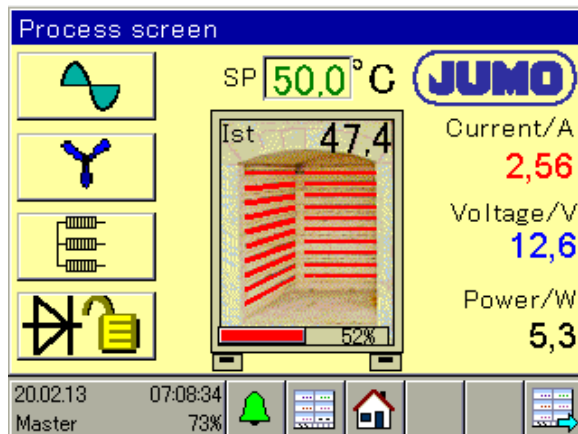

The setup program is required to design the graphics.

⇒ B 703571.0 - Chapter 13.11 "Process screen", page 129

5 Operation

Some of the levels in the device menu are username- and password-protected. The level protection is defined in the user list by the setup program, using five different users. On entering the password, each user is entitled to use the "rights" available.

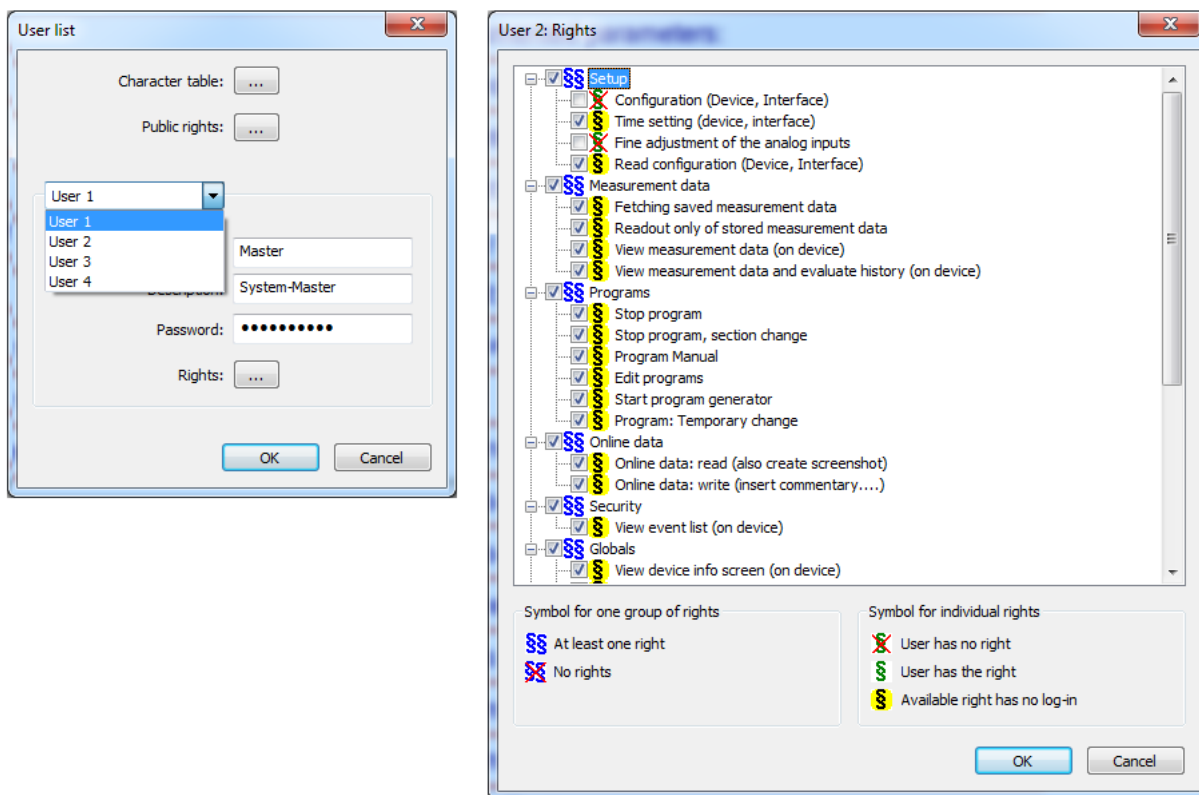

If permitted, the rights and passwords can also be changed on the device.

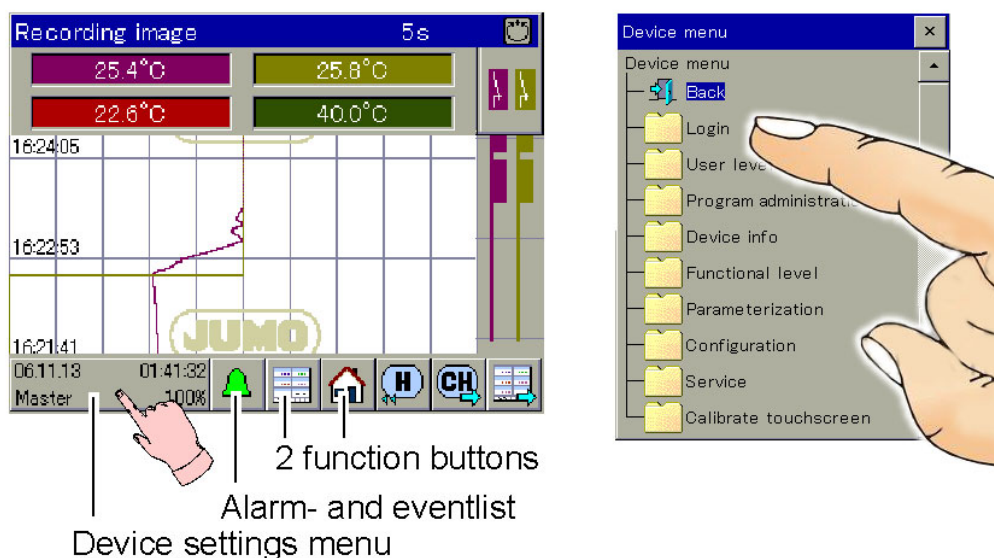

Touching the screen in the bottom left-hand corner opens the device menu window.
Touching the 'Login' function opens the Login window.

6 Login

6.1 Logging on

This sequence shows the logon process as the master user (with the default password 9200):

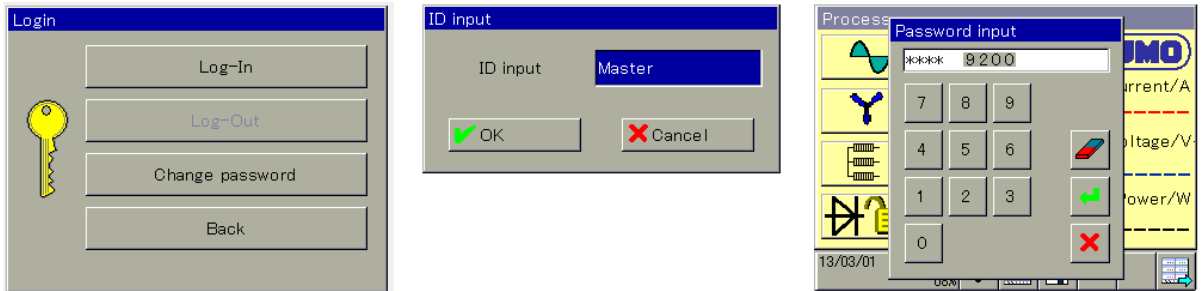

User 1 is now logged on and is permitted to access all functions listed under "Rights".

6.2 Logging out

As soon as you are logged on, the Log-Out button is no longer grayed out and touching it will enable you to log out. Consequently, your user rights will be limited.

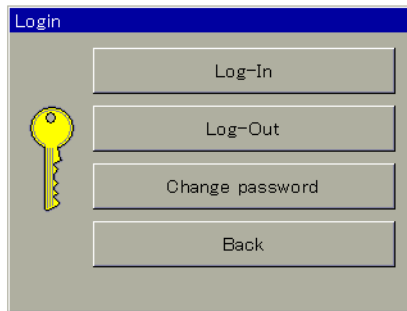

6.3 Changing the password

You can change the user password that you are currently logged in with here. To do this, you must first enter the old password (for the master user) and then the new one. If the password is incorrect, the change will not be accepted.





NOTE!

This level is empty by default and parameters can only be defined using the setup program to appear in the device.

Up to 25 parameters of any type from the configuration or parameter level can be included in this level. These parameters, for example, often need to be changed or made available to operating personnel.

ONLY SETUP > USER LEVEL

Setup dialog

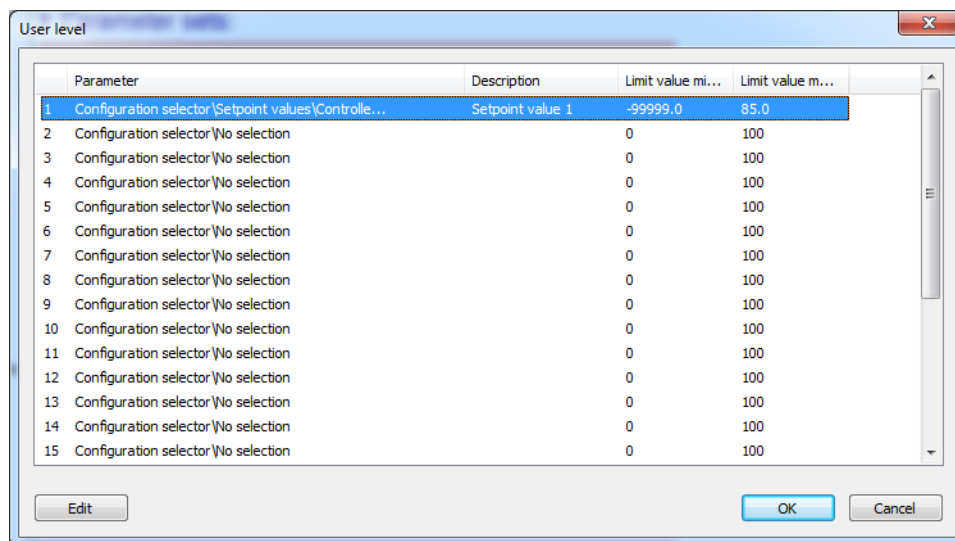

7.1 Example 4 Transferring controller setpoint values to the user level

The four reversible controller setpoint values should be transferred to the user level. Double-clicking on the empty entry opens the selector window.

Setup dialog

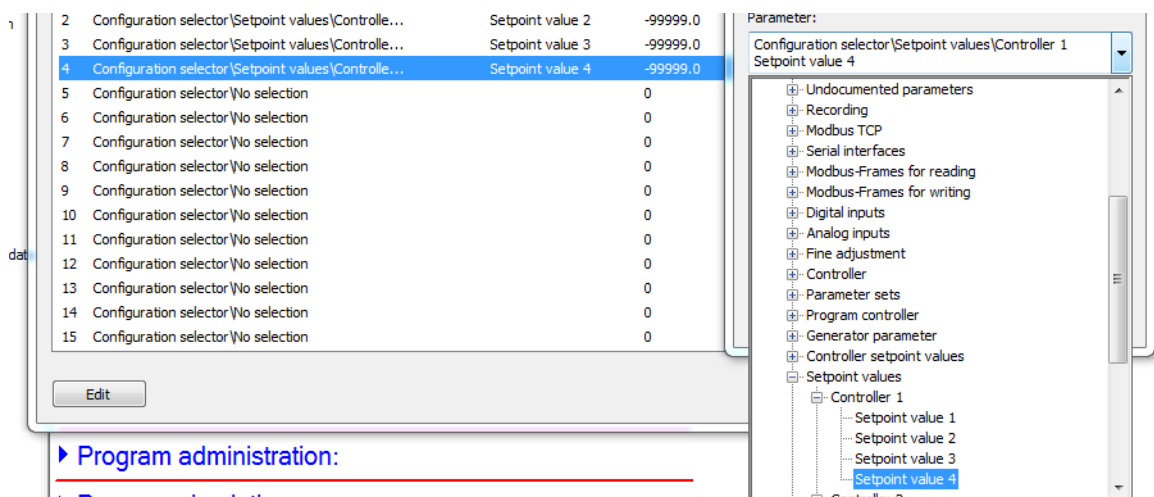

7 User level (Log-In)

Device display

Once the setup data has been transferred to the device, the setpoint values can be entered on the device.

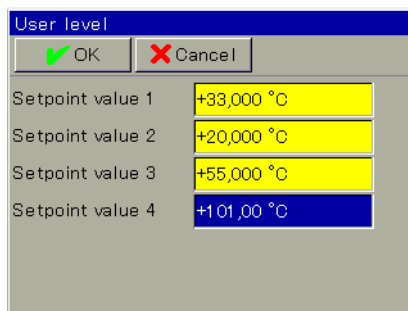

The image shows a dialog box titled "User level" with a blue header bar. Below the header are two buttons: "OK" with a green checkmark icon and "Cancel" with a red X icon. The dialog contains four rows of data, each with a label on the left and a value in a yellow box on the right:

Setpoint value 1	+33,000 °C
Setpoint value 2	+20,000 °C
Setpoint value 3	+55,000 °C
Setpoint value 4	+101,00 °C

8.1 Enter program curves

Ten programs can be entered on the device or in the setup program.

8.1.1 On the device

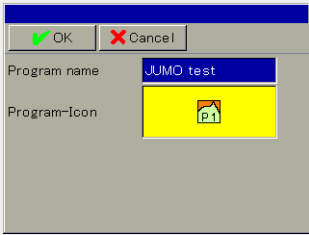
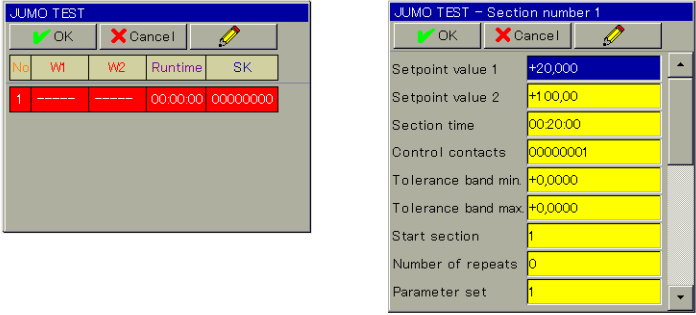
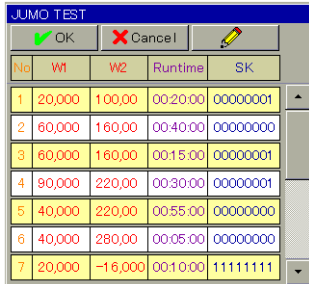
Step	Activity																																								
1	<p>Enter program names and icons</p> 																																								
2	<p>Enter first section: If the program memory is empty, the section will be highlighted in red.</p>  <p>Each section consists of: target values 1 and 2, section time, control contacts, tolerance band, number of repetitions from start section, and parameter block.</p>																																								
3	<p>Repeat section entries until the table is complete</p>  <table border="1" data-bbox="762 1406 1072 1688"> <thead> <tr> <th>No</th> <th>W1</th> <th>W2</th> <th>Runtime</th> <th>SK</th> </tr> </thead> <tbody> <tr> <td>1</td> <td>20,000</td> <td>100,00</td> <td>00:20:00</td> <td>00000001</td> </tr> <tr> <td>2</td> <td>60,000</td> <td>160,00</td> <td>00:40:00</td> <td>00000000</td> </tr> <tr> <td>3</td> <td>60,000</td> <td>160,00</td> <td>00:15:00</td> <td>00000001</td> </tr> <tr> <td>4</td> <td>90,000</td> <td>220,00</td> <td>00:30:00</td> <td>00000001</td> </tr> <tr> <td>5</td> <td>40,000</td> <td>220,00</td> <td>00:55:00</td> <td>00000000</td> </tr> <tr> <td>6</td> <td>40,000</td> <td>280,00</td> <td>00:05:00</td> <td>00000000</td> </tr> <tr> <td>7</td> <td>20,000</td> <td>-16,000</td> <td>00:10:00</td> <td>11111111</td> </tr> </tbody> </table>	No	W1	W2	Runtime	SK	1	20,000	100,00	00:20:00	00000001	2	60,000	160,00	00:40:00	00000000	3	60,000	160,00	00:15:00	00000001	4	90,000	220,00	00:30:00	00000001	5	40,000	220,00	00:55:00	00000000	6	40,000	280,00	00:05:00	00000000	7	20,000	-16,000	00:10:00	11111111
No	W1	W2	Runtime	SK																																					
1	20,000	100,00	00:20:00	00000001																																					
2	60,000	160,00	00:40:00	00000000																																					
3	60,000	160,00	00:15:00	00000001																																					
4	90,000	220,00	00:30:00	00000001																																					
5	40,000	220,00	00:55:00	00000000																																					
6	40,000	280,00	00:05:00	00000000																																					
7	20,000	-16,000	00:10:00	11111111																																					
4	<p>Touching the pencil symbol enables additional editing functions.</p> <ul style="list-style-type: none"> • Editing the program header • Copying and deleting the program • Creating a new section 																																								

- ➔ Two program curves have now been programmed.
They can be started at any section at an adjustable time and run in parallel.

8 Program administration

8.1.2 About the setup program

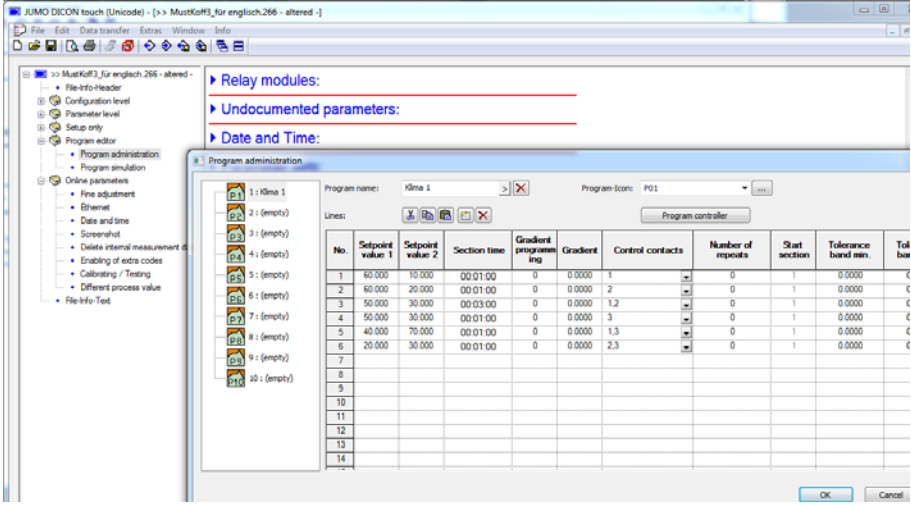
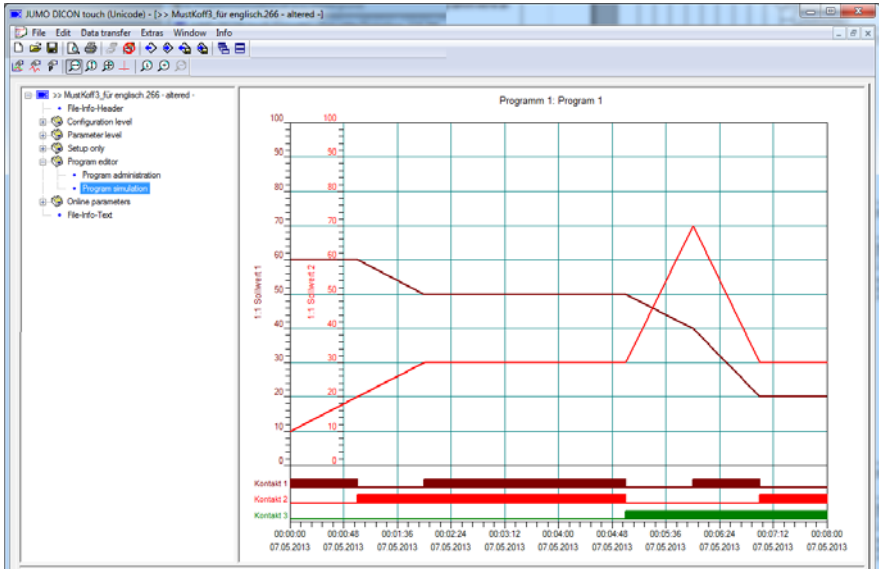
Step	Activity																																																																																																																																																																					
1	<p>Start the setup program and click on Program editor > Program administration in the menu</p>  <table border="1" data-bbox="794 651 1385 898"> <thead> <tr> <th>No.</th> <th>Setpoint value 1</th> <th>Setpoint value 2</th> <th>Section time</th> <th>Gradient programming</th> <th>Gradient</th> <th>Control contacts</th> <th>Number of repeats</th> <th>Start section</th> <th>Tolerance band min.</th> <th>Tol. bar</th> </tr> </thead> <tbody> <tr><td>1</td><td>60.000</td><td>10.000</td><td>00:01:00</td><td>0</td><td>0.0000</td><td>1</td><td>0</td><td>1</td><td>0.0000</td><td>€</td></tr> <tr><td>2</td><td>60.000</td><td>20.000</td><td>00:01:00</td><td>0</td><td>0.0000</td><td>2</td><td>0</td><td>1</td><td>0.0000</td><td>€</td></tr> <tr><td>3</td><td>50.000</td><td>30.000</td><td>00:03:00</td><td>0</td><td>0.0000</td><td>1,2</td><td>0</td><td>1</td><td>0.0000</td><td>€</td></tr> <tr><td>4</td><td>50.000</td><td>30.000</td><td>00:01:00</td><td>0</td><td>0.0000</td><td>3</td><td>0</td><td>1</td><td>0.0000</td><td>€</td></tr> <tr><td>5</td><td>40.000</td><td>70.000</td><td>00:01:00</td><td>0</td><td>0.0000</td><td>1,3</td><td>0</td><td>1</td><td>0.0000</td><td>€</td></tr> <tr><td>6</td><td>20.000</td><td>30.000</td><td>00:01:00</td><td>0</td><td>0.0000</td><td>2,3</td><td>0</td><td>1</td><td>0.0000</td><td>€</td></tr> <tr><td>7</td><td></td><td></td><td></td><td></td><td></td><td></td><td></td><td></td><td></td><td></td></tr> <tr><td>8</td><td></td><td></td><td></td><td></td><td></td><td></td><td></td><td></td><td></td><td></td></tr> <tr><td>9</td><td></td><td></td><td></td><td></td><td></td><td></td><td></td><td></td><td></td><td></td></tr> <tr><td>10</td><td></td><td></td><td></td><td></td><td></td><td></td><td></td><td></td><td></td><td></td></tr> <tr><td>11</td><td></td><td></td><td></td><td></td><td></td><td></td><td></td><td></td><td></td><td></td></tr> <tr><td>12</td><td></td><td></td><td></td><td></td><td></td><td></td><td></td><td></td><td></td><td></td></tr> <tr><td>13</td><td></td><td></td><td></td><td></td><td></td><td></td><td></td><td></td><td></td><td></td></tr> <tr><td>14</td><td></td><td></td><td></td><td></td><td></td><td></td><td></td><td></td><td></td><td></td></tr> </tbody> </table>	No.	Setpoint value 1	Setpoint value 2	Section time	Gradient programming	Gradient	Control contacts	Number of repeats	Start section	Tolerance band min.	Tol. bar	1	60.000	10.000	00:01:00	0	0.0000	1	0	1	0.0000	€	2	60.000	20.000	00:01:00	0	0.0000	2	0	1	0.0000	€	3	50.000	30.000	00:03:00	0	0.0000	1,2	0	1	0.0000	€	4	50.000	30.000	00:01:00	0	0.0000	3	0	1	0.0000	€	5	40.000	70.000	00:01:00	0	0.0000	1,3	0	1	0.0000	€	6	20.000	30.000	00:01:00	0	0.0000	2,3	0	1	0.0000	€	7											8											9											10											11											12											13											14										
No.	Setpoint value 1	Setpoint value 2	Section time	Gradient programming	Gradient	Control contacts	Number of repeats	Start section	Tolerance band min.	Tol. bar																																																																																																																																																												
1	60.000	10.000	00:01:00	0	0.0000	1	0	1	0.0000	€																																																																																																																																																												
2	60.000	20.000	00:01:00	0	0.0000	2	0	1	0.0000	€																																																																																																																																																												
3	50.000	30.000	00:03:00	0	0.0000	1,2	0	1	0.0000	€																																																																																																																																																												
4	50.000	30.000	00:01:00	0	0.0000	3	0	1	0.0000	€																																																																																																																																																												
5	40.000	70.000	00:01:00	0	0.0000	1,3	0	1	0.0000	€																																																																																																																																																												
6	20.000	30.000	00:01:00	0	0.0000	2,3	0	1	0.0000	€																																																																																																																																																												
7																																																																																																																																																																						
8																																																																																																																																																																						
9																																																																																																																																																																						
10																																																																																																																																																																						
11																																																																																																																																																																						
12																																																																																																																																																																						
13																																																																																																																																																																						
14																																																																																																																																																																						
2	Enter sections in the table																																																																																																																																																																					
3	<p>The table is displayed as a graphic with the program simulation</p> 																																																																																																																																																																					

8 Program administration

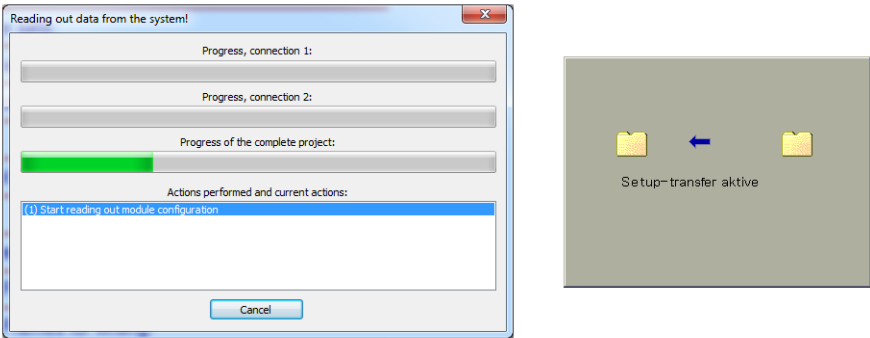
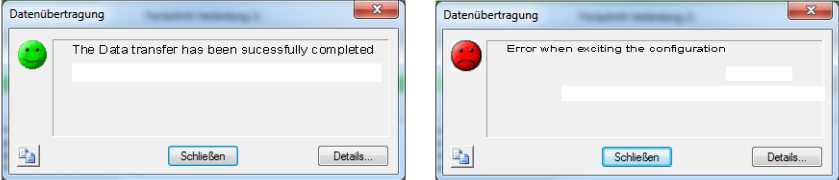
Step	Activity
4	<p>Save the setup file and transfer the setup data to the device</p> 
5	<p>If a green icon (smiley) appears, then the programs have been successfully transferred.</p> 

➔ Two program curves are now saved in the device and can be started at any section at an adjustable time and run in parallel.

8.1.3 Section run time

The period of time between sections.

Setpoint values varying from section to section create a ramp-like setpoint curve (with a negative or positive slope).

8.1.4 Setpoint values 1 and 2

Each program contains 2 setpoint value profiles which can be used to create 2 program controllers.

8.1.5 Control contacts

Eight control contacts can be set at any one time. They are available in the digital selector and can switch on relays, for instance.

⇒ Setup program:

CONFIGURATION LEVEL > DIGITAL OUTPUTS

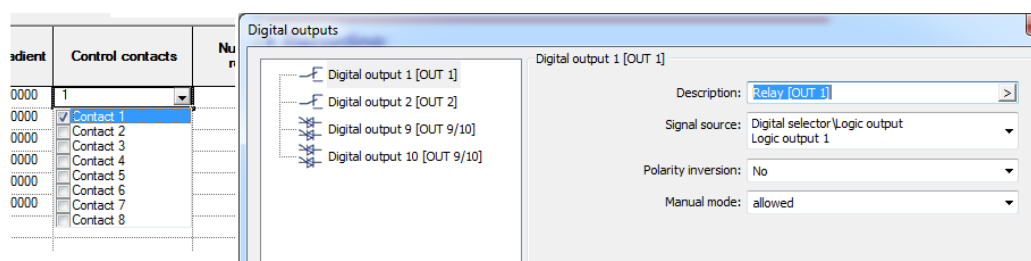

They can also be logically linked or can initiate internal device functions.

8 Program administration

8.1.6 Tolerance band

⇒ B 703571.0 - Chapter 12.6.7 "Ramp function", page 95

8.1.7 Number of repetitions

The number of repetitions is entered for a specific start section.

8.1.8 Start section

Repetition begins from this section.

Example

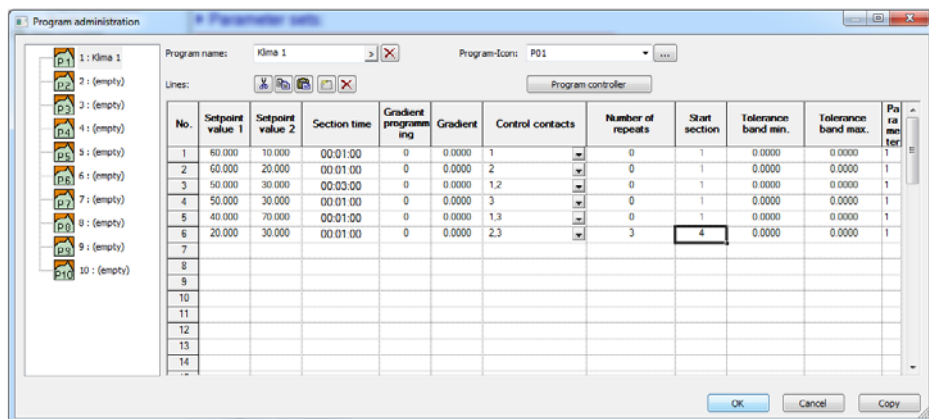

The screenshot shows the 'Program administration' window with a table of program lines. The table has columns for 'No.', 'Setpoint value 1', 'Setpoint value 2', 'Section time', 'Gradient programming', 'Gradient', 'Control contacts', 'Number of repeats', 'Start section', 'Tolerance band min.', 'Tolerance band max.', and 'Parameter'. Line 6 is highlighted, showing 3 repeats starting from section 4.

No.	Setpoint value 1	Setpoint value 2	Section time	Gradient programming	Gradient	Control contacts	Number of repeats	Start section	Tolerance band min.	Tolerance band max.	Parameter
1	60.000	10.000	00:01.00	0	0.0000	1	0	1	0.0000	0.0000	1
2	60.000	20.000	00:01.00	0	0.0000	2	0	1	0.0000	0.0000	1
3	50.000	30.000	00:03.00	0	0.0000	1,2	0	1	0.0000	0.0000	1
4	50.000	30.000	00:01.00	0	0.0000	3	0	1	0.0000	0.0000	1
5	40.000	70.000	00:01.00	0	0.0000	1,3	0	1	0.0000	0.0000	1
6	20.000	30.000	00:01.00	0	0.0000	2,3	3	4	0.0000	0.0000	1
7											
8											
9											
10											
11											
12											
13											
14											
--											

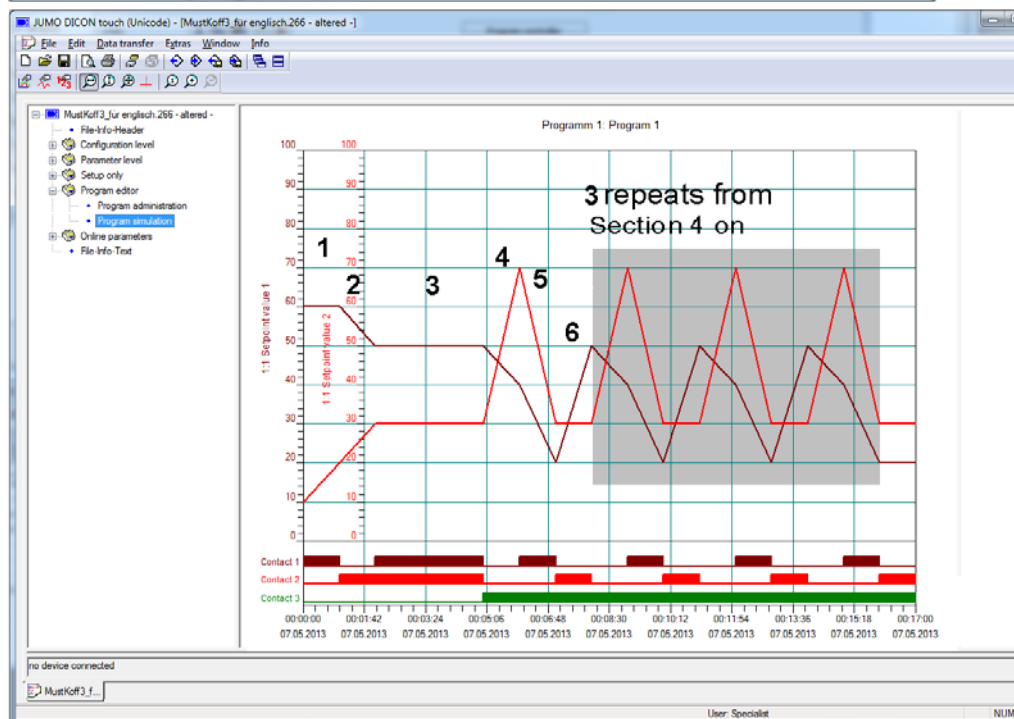

8.1.9 Parameter block

For each controller channel, parameter blocks 1 to 4 are available and can be switched in any combination

The device information function enables hardware and software modules to be displayed.

9.1 General information

The type extra codes enabled in the device are displayed next to the device names.

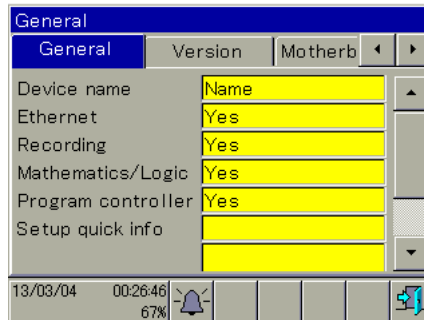

9.1.1 Version, motherboard, Ethernet information

Software version, fabrication number, and testing ID are displayed.

Displays the hardware on the motherboard.

MAC address, IP address, gate address, DNS address, and transfer rate.

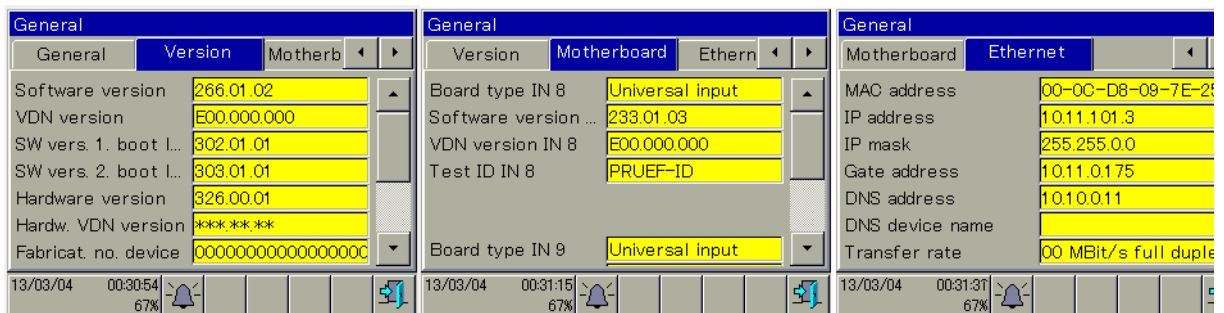

9.2 Slots

Assignment of expansion slots is displayed in the device.

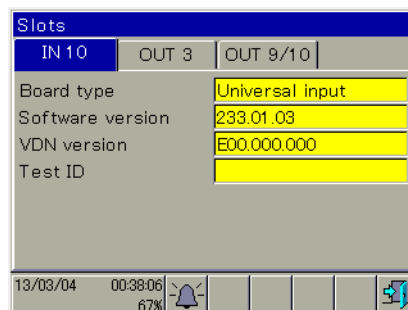

9.3 Inputs/outputs

The switching statuses and measurement values are displayed here.

9 Device information

9.3.1 Digital and analog inputs, digital and analog outputs, external digital, and external analog inputs

The figure displays six screenshots of the 'Inputs/Outputs' configuration interface, arranged in a 3x2 grid. Each screenshot shows a different configuration tab and its corresponding data.

- Top Left: Digital inputs**

IN 1:	1
IN 2:	1
IN 3:	0
IN 4:	0
IN 5:	0
IN 6:	0
IN 7:	0
- Top Right: Analog inputs**

IN 8:	21.686 °C
IN 9:	20.945 °C
IN 10:	----- %
IN 11:	----- %
- Middle Left: Digital outputs**

OUT 1:	0	OUT 7:	0
OUT 2:	0	OUT 8:	0
OUT 3:	0	OUT 9:	0
OUT 4:	0	OUT 10:	0
OUT 5:	0	OUT 11:	0
- Middle Right: Analog outputs**

OUT 3:	8,1201 mA	40,601 %
OUT 5:	0.0000 V	0.0000 %
OUT 7:	0.0000 V	0.0000 %
OUT 9:	0.0000 V	0.0000 %
OUT 11:	0.0000 V	0.0000 %
- Bottom Left: External digital inputs**

1:	0	5:	0
2:	0	6:	0
3:	0	7:	0
4:	0	8:	0
- Bottom Right: External analog inputs**

1:	----- %	5:	----- %
2:	----- %	6:	----- °C
3:	----- %	7:	----- %
4:	----- %	8:	----- %

9.4 Functions

9.4.1 Mathematics, logic signal, limit value outputs

The figure displays three screenshots of the 'Functions' configuration interface, arranged horizontally. Each screenshot shows a different configuration tab and its corresponding data.

- Left: Mathematics**

No.	Mathematics	No.	Mathematics
1	<<<<<<	5	<<<<<<
2	<<<<<<	6	<<<<<<
3	<<<<<<	7	<<<<<<
4	<<<<<<	8	<<<<<<
- Middle: Logic signal**

No.	Logic signal	No.	Logic signal
1	0	5	0
2	0	6	0
3	0	7	0
4	0	8	0
- Right: Limit value outputs**

No.	Output	No.	Output
1	0	9	0
2	0	10	0
3	0	11	0
4	0	12	0
5	0	13	0

9.4.2 Timer signal, digital controller signals, control contacts, controller, analog flag, digital flag

The following tables represent the data shown in the screenshots:

Timer signals

No.	Timer run time	Timer output
1	00:00:00	0
2	00:00:00	0

Digital control signals

No.	Output	No.	Output
1	0	5	0
2	0	6	0
3	0	7	0
4	0	8	0

Control contact

No.	Control contact	No.	Control contact
1	0	5	0
2	0	6	0
3	0	7	0
4	0	8	0

Controller

Controller	Parameter set	Setpoint value
1	1	1
2	1	1

Analog flag

No.	Analog flag	No.	Analog flag
1	0.0000	5	0.0000
2	0.0000	6	0.0000
3	0.0000	7	0.0000
4	0.0000	8	0.0000

Digital flag

No.	Digital flag	No.	Digital flag
1	0	5	0
2	0	6	0
3	0	7	0
4	0	8	0

9.5 Status

9.5.1 Ethernet status 1 to 9

The screenshot shows the following data:

Ethernet status	Value
Ethernet status 1	342162
Ethernet status 2	49362
Ethernet status 3	15396
Ethernet status 4	0
Ethernet status 5	14649
Ethernet status 6	0
Ethernet status 7	16001
Ethernet status 8	0
Ethernet status 9	0

9 Device information

10.1 General information



NOTE!

The functional level is faded out by default and must be activated using the setup program.

10.1.1 Activate functional level

The functional level is activated in the screen menu and subsequently appears in the device menu.

⇒ Chapter 12.10 "Screen", page 106

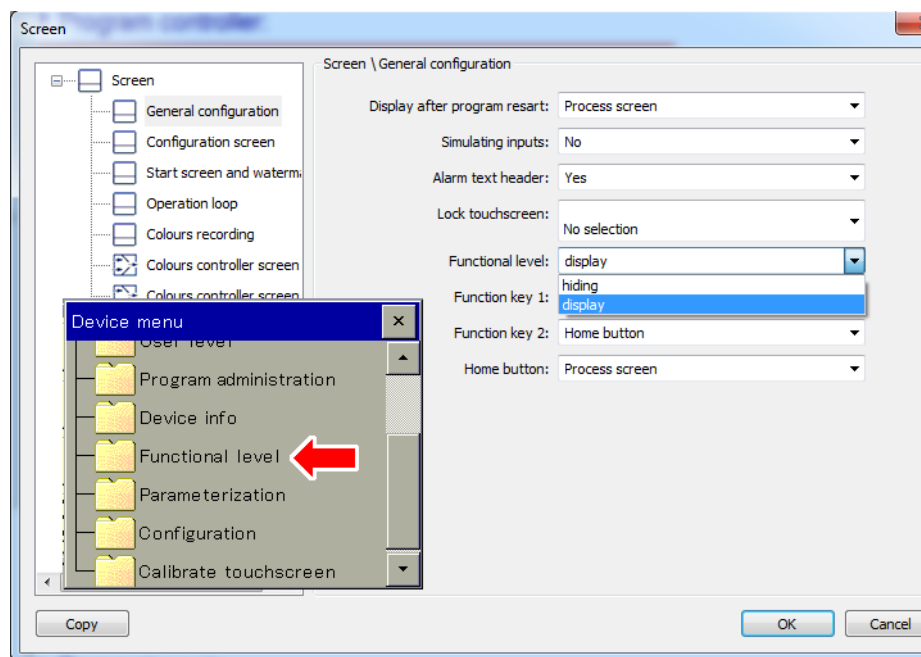

The functional level is used primarily for testing and diagnostic purposes. Analog and binary values of the outputs can be controlled manually here. This may be useful, for instance, for checking an individual piece of equipment in a plant. For maintenance and repair works, for example, the timer, ramp function, and limit value monitoring can be operated and switching operation can be acknowledged.

Example for the timer

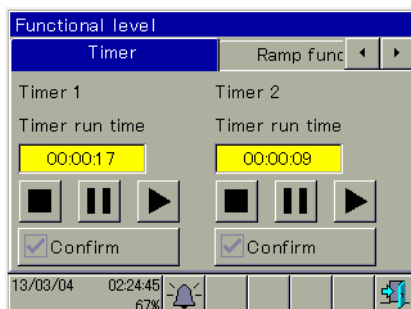

10 Functional level



NOTE!

The parameters described in this section can be entered either in the setup program or in DI-CON touch. This is where the parameters that are directly linked to the alignment of the controller with the control path are set, after the system has been commissioned.

You must be logged in to change the parameters.

- ⇒ Device menu section > Login
- ⇒ Chapter 7 "User level (Log-In)", page 45

Setup dialog

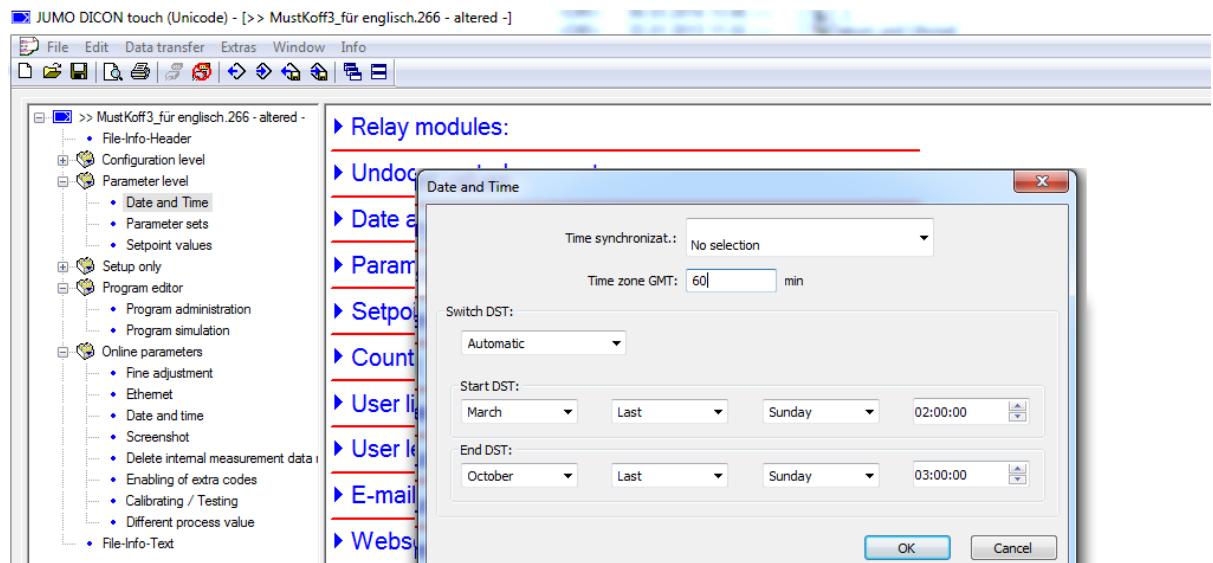

11.1 Date and time

The following table shows the time settings for the device.

Parameter	Setting	Description
Current date	2011/01/01 2083/12/31	Enter the date here.
Current time	00:00:00 23:59:59	Enter the time here.

11.2 Daylight saving time

The following table shows the settings for daylight saving time.

Parameter	Setting	Description
Synchronization	No function Digital selector	A digital signal can be selected here to synchronize the time.
Switch daylight saving time	Automatic Inactive	Enables you to set the time to change automatically.

11 Parameterization

Parameter	Setting	Description
Start DST	Month: March Week: last week Day: Sunday Time: 02:00:00	
End DST	Month: October Week: last week Day: Sunday Time: 03:00:00	

11.3 Controller/parameter blocks

Setup dialog

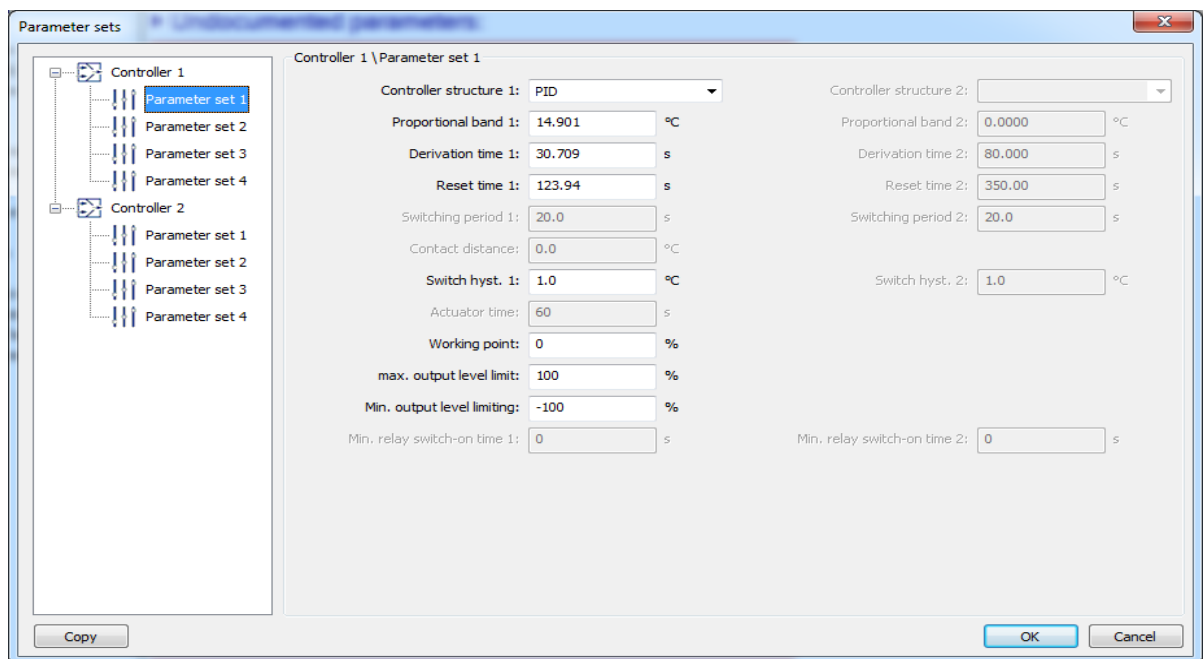

The following table shows the parameters in a parameter block. These parameters are also available for the other three parameter blocks. Two parameter blocks can be defined for each of the two controller channels. Switching the parameter blocks is performed separately for each controller channel via a digital signal.

Depending on the controller type configured, certain parameters may be omitted or ineffective. Parameters that appear in pairs such as Proportional band 1 and 2 refer to the first and second controller outputs (for instance, with three-state controllers).

The parameter blocks are assigned to both controllers in the configuration level.

⇒ B 703571.0 - Chapter 12.6.2 "Controller inputs", page 80

11 Parameterization

Parameter	Setting	Description
Proportional band 1 (Xp1)	0 ... 9999	Value for the proportional band The controller structure has no effect if $X_p = 0$ (behavior identical to limit value monitoring)! For a continuous controller, X_p must be > 0 .
Proportional band 2 (Xp2)	0 ... 9999	
Derivative time 1 (Tv1)	0 ... 80 ... 9999 s	The derivative time influences the differential component (D component) of the controller output signal. The greater the derivative time, the more effect the D component has.
Derivative time 2 (Tv2)	0 ... 80 ... 9999 s	
Reset time 1 (Tn1)	0 ... 350 ... 9999 s	The reset time influences the integral component (I component) of the controller output signal. The greater the reset time, the less effect the I component has.
Reset time 2 (Tn2)	0 ... 350 ... 9999 s	
Cycle time 1 (Cy1)	0 ... 20 ... 999.9 s	When using a switched output, the cycle time should be chosen so that the energy supply to the process is as continuous as possible without overloading the switching elements.
Cycle time 2 (Cy2)	0 ... 20 ... 999.9 s	
Contact spacing (Xsh)	0 ... 999.9	Spacing between the two control contacts for a three-state controller, modulating controller, and continuous controller with integrated position controller
Switching differential 1 (Xd1)	0 ... 1 ... 999.9	Hysteresis for a switching controller with proportional band $X_p = 0$
Switching differential 2 (Xd2)	0 ... 1 ... 999.9	
Actuator time (TT)	5 ... 60 ... 3000 s	Control valve running time range used for a modulating controller and continuous controller with integrated position controller
Working point (Y0)	-100 to 0 to +100 %	Working point correction for a P or PD controller (correction value for the output level) If the actual value (x) has reached the setpoint value (w), the output level (y) corresponds to the working point (Y0).
Max. output level limit (Y1)	0 to 100 %	Admissible maximum output level (only effective if $X_p > 0$)

11 Parameterization

Parameter	Setting	Description
Min. output level limit (Y2)	-100 to +100 %	Admissible minimum output level (only effective if $X_p > 0$)
Minimum relay ON period 1 (Tk1)	0 to 60 s	Limits the frequency of switching for switched outputs
Minimum relay ON period 2 (Tk2)	0 to 60 s	

Transmission behavior

The transmission behavior (controller structure) is determined by the configuration of the parameters for the proportion band (P component), derivative time (D component), and reset time (I component).

Two-state controller

This controller has a switched output and can be parameterized with P, PI, PD, or PID transmission behavior. The proportional band X_p must be greater than 0 for the controller structure to take effect.

If $X_p = 0$, the behavior corresponds to the function of limit value monitoring with switching differential X_{d1} (working point $Y_0 = 0\%$):

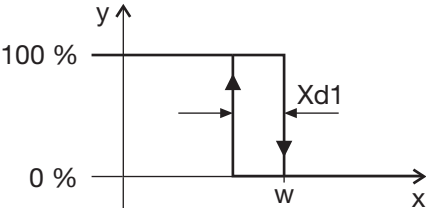

Influence of working point Y_0 on the switching behavior

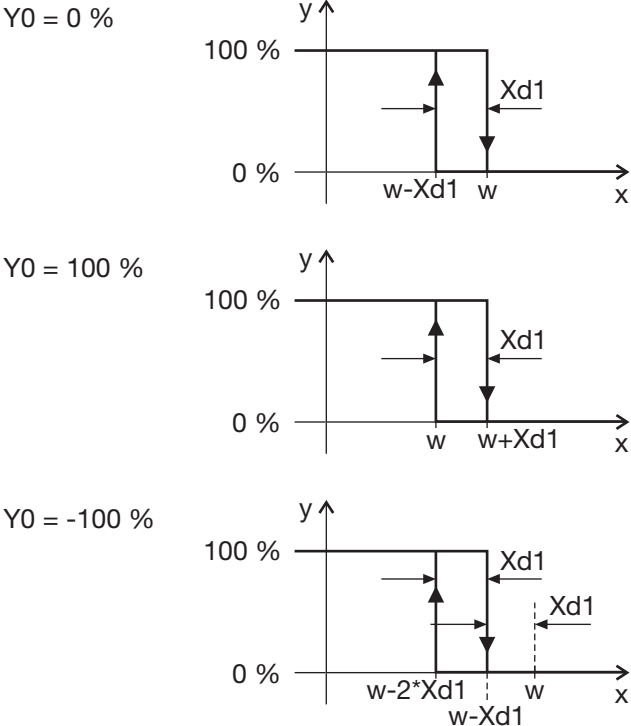

11 Parameterization

Three-state controller

This controller has two outputs, which can be configured as continuous (analog output) or switched (digital output). In both cases, the controller can be parameterized with P, PI, PD, or PID transmission behavior. The proportional bands $Xp1$ and $Xp2$ must be greater than 0 for the controller structure to take effect.

If $Xp1 = 0$ and $Xp2 = 0$, the behavior corresponds to the function of limit value monitoring with switching differential $Xd1$ and $Xd2$, and contact spacing Xsh (working point $Y0 = 0\%$):

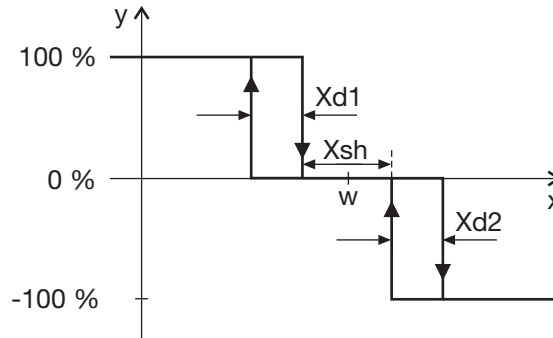

Modulating controller

This controller has two switched outputs and can be parameterized with PI or PID transmission behavior. The proportional band Xp must be greater than 0 for the controller structure to take effect.

The modulating controller is used for actuator drives with three switching statuses (actuator open, closed, hold). If output level feedback is available, the active output is deactivated when the output level limits are reached.

Continuous controller

This controller has a continuous output (analog output) and can be parameterized with P, PI, PD, or PID transmission behavior. The proportional band Xp must be greater than 0 for the controller structure to take effect (the setting $Xp = 0$ is normally used in practice).

Position controller

This controller is a continuous controller with integrated position controller and two switched outputs (digital outputs) with PI or PID transmission behavior.

The position controller is used for actuator drives with three switching statuses (actuator open, closed, hold). An output level feedback is required.

11.4 Setpoint values

Four switchable setpoint values are assigned to a fixed-setpoint controller and can be entered on the device or in the setup program.

The following table shows the setpoint changeover for fixed-setpoint controllers using two digital signals that can be Chapter 12.6.6 "Controller setpoint values", page 93 set.

For program controllers

⇒ Chapter 8.1 "Enter program curves", page 47

11 Parameterization

Type	Signal 2 (Bit 1) setpoint changeover	Signal 1 (Bit 0) setpoint changeover	Setpoint value, Controller 1	Setpoint value, Controller 2
Fixed-setpoint controller	0	0	Setpoint value 1	Setpoint 1
	0	1	Setpoint value 2	Setpoint value 2
	1	0	Setpoint value 3	Setpoint value 3
	1	1	Setpoint value 4	Setpoint value 4
Program controller			W1 and W2 are predefined by the program generator	

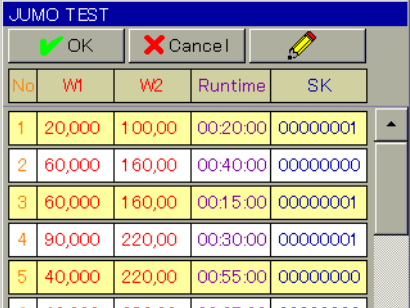

11.4.1 Entered on the device

The setpoint values in the parameter level are entered on the device.

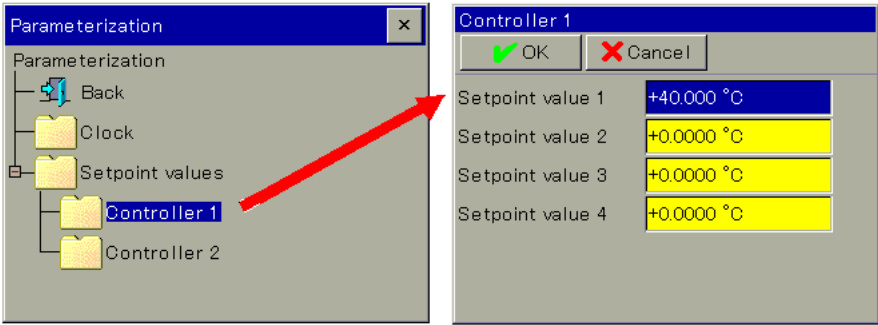

11.4.2 Entered using the setup program

The setpoint values are entered in the setup dialog parameter level.

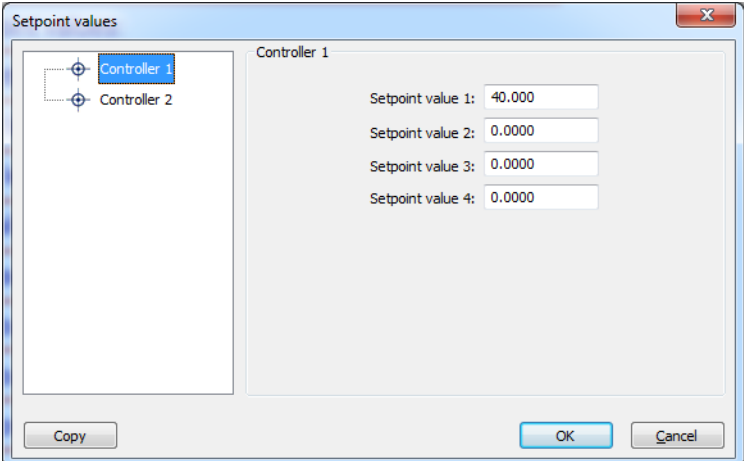

11 Parameterization



NOTE!

The parameters described in this section can be edited using either the setup program or DICON touch. The settings (for example, measured value recording, outputs, Ethernet, and controller type) that are required immediately for commissioning in a specific plant and therefore that seldom need to be changed, are set here.

Depending on the configuration, signals which are not in use are grayed out. Functions available in both selectors are highlighted in a specific color.

12.1 Analog selector

- Analog selection
- No selection
- Analog inputs
- External analog input
- Mathematics
- Controller
- Setpoint values
- Program setpoint val.
- Section end values
- Flag
- Service
- Sampling periode

The analog selector contains all analog signals available in the configuration dialogs of a tree structure in the DICON touch.

All analog signals are shown in the following table. The entry in the "Type" column indicates the source of the signal:

- Internal: Internal signal for the DICON touch (including signals from the analog inputs)
- External: External input, for example, one that can be transmitted via an interface

Category	Signal	Type	Description
No function			No signal selected
Analog inputs	Analog input (IN8) Analog input (IN9) Analog input (IN10) Analog input (IN11)	Internal	Measured values for analog inputs 1 to 4 ⇒ Siehe 7312.5 Analog inputs IN8, IN9, IN10, IN11
External analog inputs	External analog inputs 1 to 8	External	Analog value for the external analog input 1 to 8 ⇒ Siehe 13512.18 External analog inputs
Mathematics	Mathematics 1 to 8	Internal	Result of mathematical function 1 to 8 ⇒ Siehe 13012.15 Mathematics/logic
Controller 1	Actual value for Controller 1 Setpoint value, Controller 1 Controller differential, Controller 1 Output level display, Controller 1 Output 1, Controller 1 Output 2, Controller 1 Cascade output level, Controller 1	Internal	⇒ Siehe 7712.6.1 Controller configuration
Controller 2	Actual value, Controller 2 Setpoint value, Controller 2 Controller differential, Controller 2 Output level display, Controller 2 Output 1, Controller 2 Output 2, Controller 2 Cascade output level, Controller 2		

12 Configuration

Category	Signal	Type	Description
Setpoint values	Ramp end value, Controller 1 Setpoint specification, Controller 1 Setpoint value 1 to 4, Controller 1 Ramp end value, Controller 2 Setpoint specification, Controller 2 Setpoint value 1 to 4, Controller 2	Internal	Setpoint value for controller channel 1 to 2 as fixed setpoint controller ⇒ Siehe 9312.6.6Controller setpoint values
Program setpoint	Program setpoint 1, 2	Internal	Setpoint value for controller channel 1 to 2 as program controller ⇒ Siehe 11612.12Program controller
Section end values	Section end value 1 to 2	Internal	
Flags	Flags 1 to 8	Internal	Analog value of the analog flag ⇒ Siehe 13212.16Flags/service
Service	Terminal temperature	Internal	Measured value (internal Pt100)
Sampling rate	Sampling rate	Internal	Measured value, sampling rate

12.2 Digital selector

- Digital selector
- No selection
- + Controller
- + Digital inputs
- + External digital inputs
- + Digital control signals
- + Limit value outputs
- + Timer
- + Logic output
- + Ramp signals
- + Program controller
- + Control contacts

The digital selector contains all digital signals that are available in the configuration dialogs of a tree structure in the DICON touch.

All the digital signals are shown in the following table. The entry in the "Type" column indicates the source of the signal:

- Internal: Internal signal for the DICON touch (including digital input signals)
- External: External value is transferred via the interface, for example

Category	Signal	Type	Description
No function			No signal selected
Controller 1	1st output, Controller 1	Internal	Switching outputs, Controller 1 Logic level "0", function inactive Logic level "1", function inactive ⇒ Siehe 7712.6.1Controller configuration
	2nd output, Controller 1		
	Self-optimization, Controller 1		
	Manual mode, Controller 1		
	Controller 1, off		
	Controller cycle alarm 1		
Controller 2	1st output, Controller 2	Internal	Switching outputs, Controller 2 Logic level "0", function inactive Logic level "1", function inactive ⇒ Siehe 7712.6.1Controller configuration
	2nd output, Controller 2		
	Self-optimization, Controller 2		
	Manual mode, Controller 2		
	Controller 2, off		
	Controller cycle alarm 2		
	Output level alarm 1		
	Output level alarm 2		

12 Configuration

Category	Signal	Type	Description
Digital inputs	Digital input 1 to 7	Internal	Logic level for connected floating contacts 1 to 7 ⇒ Siehe 7212.4Digital inputs IN1 to 7
External digital inputs	External digital input 1 to 8	External	Logic level for the external digital inputs 1 to 8 ⇒ Siehe 13412.17External digital inputs
Digital controller signals	Digital controller signals 1 to 8	Internal	Logic level for the defined digital controller signals 1 to 8 ⇒ Siehe 12612.14Digital controller signals
Limit value outputs	Limit value output 1 to 16	Internal	Logic level of the limit value monitoring 1 to 16 ⇒ Siehe 10012.9Limit value monitoring
Timer	Timer output 1 Timerendsignal 1 Timertoleranceband 1 Timerstoppsignal 1 Timeroutput 2 Timerendsignal 2 Timertoleranceband 2 Timerstoppsignal 2	Internal	Logic level of the output signals for Timer 1, 2 Logic level "0", function inactive Logic level "1", function inactive ⇒ Siehe 12412.13Timer or time switch
Logic output	Logic output 1 to 8	Internal	Result of logic function 1 to 8 ⇒ Siehe 13012.15Mathematics/logic
Ramp signals	Rampendsignal 1 Tolerancebandsignal 1 Rampendsignal 2 Tolerancebandsignal 2	Internal	Logic level "0", function inactive Logic level "1", function inactive ⇒ Siehe 9512.6.7Ramp function
Program controller	Program end signal Programautosignal Tolerancebandsignal Programstoppsignal	Internal	Logic level "0", function inactive Logic level "1", function inactive ⇒ Siehe 11612.12Program controller
Control contacts	Control contacts 1 to 8	Internal	Logic level of the control contacts, for example in automatic mode. ⇒ Siehe 498.1.5Control contacts
Flags	Digital flags 1 to 8	Internal	Logic level of the digital flag ⇒ Siehe 13212.16Flags/service
Service	Service signal	Internal	Logic level of the service signal ⇒ Siehe 13212.16Flags/service

12 Configuration

Category	Signal	Type	Description
Function buttons	Function button 1 to 2	Internal	Logic level of the two function buttons ⇒ Siehe 355.1 Display and operating concept
Analog input alarm	MinAlarm IN8 MaxAlarm IN8 MinAlarm IN9 MaxAlarm IN9 MinAlarm IN10 MaxAlarm IN10 MinAlarm IN11 MaxAlarm IN11	Internal	Min and max alarm signals of the analog inputs 1 to 4 ⇒ Siehe 7312.5 Analog inputs IN8, IN9, IN10, IN11
Ext. analog entry alarm	MinAlarm Ext. AE 1 MaxAlarm Ext. AE 1 MinAlarm Ext. AE 2 MaxAlarm Ext. AE 2 MinAlarm Ext. AE 3 MaxAlarm Ext. AE 3 MinAlarm Ext. AE 4 MaxAlarm Ext. AE 4 MinAlarm Ext. AE 5 MaxAlarm Ext. AE 5 MinAlarm Ext. AE 6 MaxAlarm Ext. AE 6 MinAlarm Ext. AE 7 MaxAlarm Ext. AE 7 MinAlarm Ext. AE 8 MaxAlarm Ext. AE 8	Internal	Min and max alarm signals for the ext. analog inputs 1 to 8 ⇒ Siehe 13512.18 External analog inputs
Math alarm	MinAlarm Math 1 MaxAlarm Math 1 MinAlarm Math 2 MaxAlarm Math 2 MinAlarm Math 3 MaxAlarm Math 3 MinAlarm Math 4 MaxAlarm Math 4 MinAlarm Math 5 MaxAlarm Math 5 MinAlarm Math 6 MaxAlarm Math 6 MinAlarm Math 7 MaxAlarm Math 7 MinAlarm Math 8 MaxAlarm Math 8	Internal	⇒ Siehe 13012.15 Mathematics/logic

12 Configuration

Category	Signal	Type	Description
Digital alarms	Digital alarm 1 to 7	Internal	Alarms for connected floating contacts 1 to 7 ⇒ Siehe 7212.4Digital inputs IN1 to 7
Ext. digital alarms	Ext. digital alarm 1 to 8	External	Alarms for ext. digital inputs ⇒ Siehe 13412.17External digital inputs
Digital control alarms	Digital control alarm 1 to 8	Internal	Alarms for the defined digital controller signals 1 to 8 ⇒ Siehe 12612.14Digital controller signals
Limit value alarms	Limit value alarm 1 to 16	Internal	Alarms for the limit value monitoring 1 to 16 ⇒ Siehe 10012.9Limit value monitoring
Logic alarms	Logic alarms 1 to 8	Internal	Alarms for logic function 1 to 8 ⇒ Siehe 13012.15Mathematics/logic
Alarms and internal signals	Collective alarm	Internal	Collective alarm for the controller
	Collective alarm acknowledged		
	Memory alarm		Memory alarm limit exceeded ⇒ Siehe 7012.3Basic settings
	Fault		
	Field bus error		
	Battery empty		Back-up battery must be replaced
	Pre-alarm battery		Back-up battery voltage under 2.6 V
	Login		Logic level "0", user not logged on Logic level "1", user logged on
	USB inserted		Logic level "0" USB not inserted Logic level "1", USB inserted
	Temp. in Fahrenheit		Logic level "0", temp. not °F Logic level "1", temp. in °F
	Inside temperature too high	Logic level "0", inside temperature not too high Logic level "1", inside temperature too high	

12 Configuration

12.3 Basic settings

The settings are applicable for the entire device.

Setup dialog

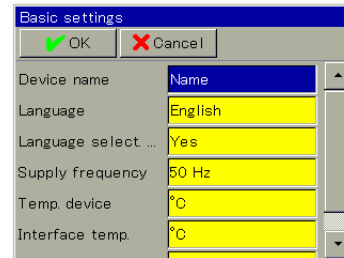
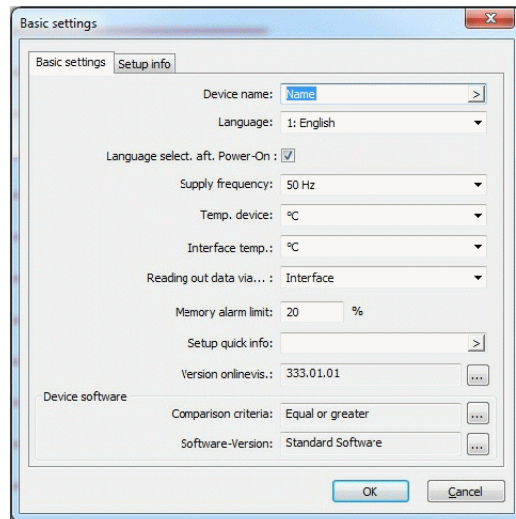

Parameter

Parameter	Selection/settings	Description
Device name	Name	20 characters of editable text
Language	1.German 2.English	The device can save up to two languages. Additional languages can only be added using the setup program: EDIT > SETUP ONLY > COUNTRY SETTINGS . ⇒ Chapter 13.3 "Country settings", page 122
Language selection after "power on"		
&	Not selected (empty); no Selected (); yes	The device starts without language selection The language selection appears
Supply frequency	50 Hz 60 Hz	
Temp. of device	Deg. Celsius Deg. Fahrenheit	Temperature unit for displaying the temperature in the device
Temp. of interface	Deg. Celsius Deg. Fahrenheit	Temperature unit for displaying the temperature values using the interface
Read out data using: (only setup)	Interface USB	Secure recording data using the interface Secure recording data on the stick ⇒ Chapter 12.11 "Recording", page 113
Memory alarm limit (in the device) 📖	0 to 20 % to 100 %	If the enabled memory data recorder does not reach this limit in the device, an alarm will be issued.
Setup quick info	-	Any text may be transferred to the device during the data transfer.

Parameter	Selection/settings	Description
Online version vis. (only setup)	Standard online visualization	Software version of the webserver software
	No online visualization	
	Example 333.01.01-13	If relevant, additional versions are listed that can be selected in the version library and can be specifically selected for the software update.
Comparison criteria (only setup)	Compatible Equal to or greater than	Setup software<->device software
Software version (only setup)	Standard software	The device software version is available here

Language selection after power ON

This setting means that language selection appears following "power on", which gives the user the opportunity to select their preferred language.

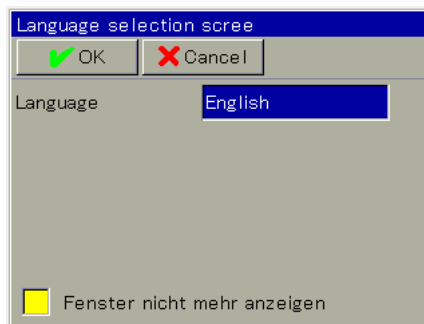

Memory alarm limit

If 20 % of the enabled memory is not used during recording, for example, an entry will be made in the alarm list. This enables the user to recover the recording data using the USB stick or the interface (as indicated).

The value of the free memory only returns to 100 % when the data has been recovered. If the remaining 20 % is used up, the oldest recorded data is overwritten and replaced with the new data. In this case, there will be a recording gap.

12 Configuration



12.4 Digital inputs IN1 to 7

A maximum of seven digital inputs (IN 1 to 7) are available for connecting to floating contacts with a common ground.

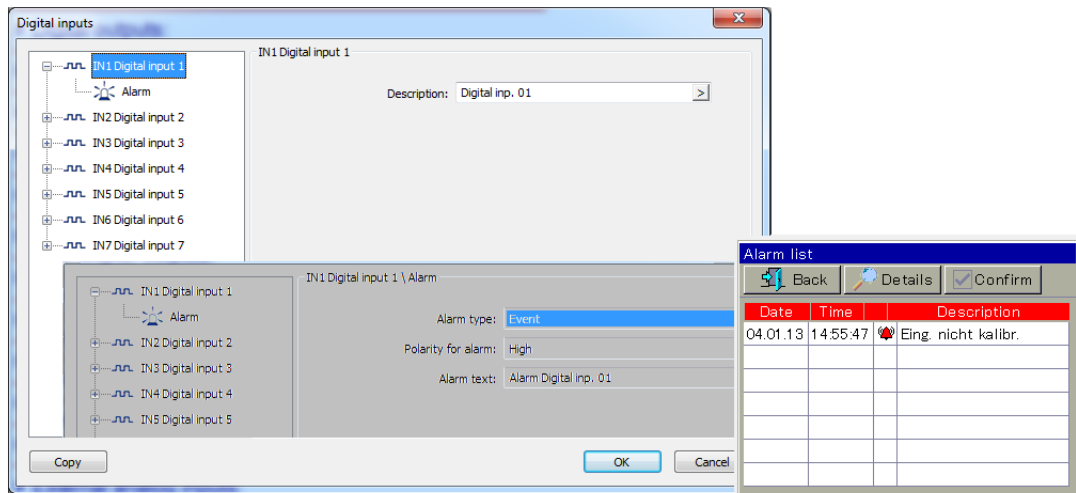
Setup dialog



Parameter

Parameter	Selection/settings	Description
Channel description	Digital input 01	(15 characters) of editable text that indicates, for example, what the signal will be used for.
Alarm type	Off	Alert switched off.
	Alarm	A message will be entered in the alarm list depending on the signal level that has been set.
	Event	A message will be entered in the events list depending on the signal level that has been set.
Polarity for alarm  (only setup)	Signal level that triggers an alarm or an event. High Low	Contact closed: high (logic "1") Contact open: low (logic "0")
Alarm text (only setup) 	Digital input alarm 01	20 characters of editable text which is entered into the alarm or event list.

Polarity for alarm

An alarm is only displayed for as long as the signal level (closed contact) is also selected. If the contact is opened, the alarm entry disappears automatically.

Alarm text

The setup program is required to view and edit the texts.

12.5 Analog inputs IN8, IN9, IN10, IN11



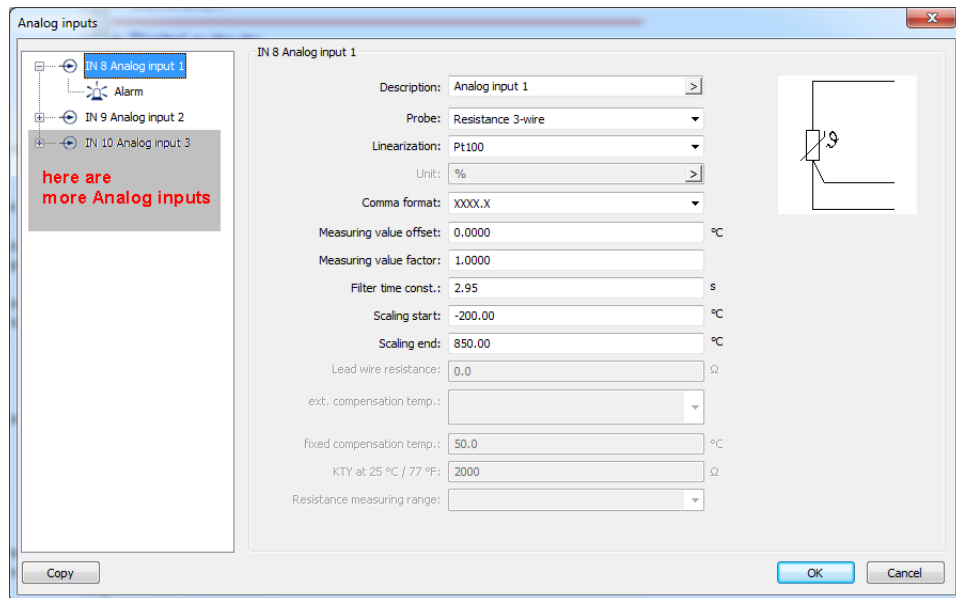

Analog inputs IN8 and IN9 are installed by default as universal measuring inputs for RTD temperature probes, thermocouples, resistance transmitters/resistance potentiometers, and standard signals. Two additional analog inputs, IN10 and IN11, can be retrofitted.

Setup dialog



Parameter

Parameter	Selection/settings	Description
Channel description	Analog input IN8, IN9, IN10, IN11	(15 characters) of editable text
Probes	Selection of measuring probe for the relevant analog input	
	No function	No sensor selected
	Res.three-wire	RTD temperature probe in three-wire circuit
	Res.two-wire	RTD temperature probe in two-wire circuit
	Int. thermocouple	Internal thermocouple Cold-junction temperature
	Ext. thermocouple	External thermocouple Cold-junction temperature
	Constant thermocouple	Constant thermocouple Cold-junction temperature
	Resistance transmitter	Resistance transmitter
	0 to 20 mA	Standard signal
	0 to 10 V	Standard signal
	0 to 1 V	Standard signal
	0 ...to 100 mV	Standard signal
	4 to 20 mA	Standard signal
	2 to 10 V	Standard signal

Parameter	Selection/settings	Description
Measured value offset 	-100 to 0 to +100	Parallel translation of all measured values
Measured value factor 	1,000	Slope
Filter time constant 	0 to 0.6 to 100	Time constant for adjusting the digital input filter (0 s = filter off)
Start of scaling 	Default setting depends on sensor and linearization.	
	-99999 to +99999	Start value of display range for standard signals
Scaling end 	Default setting depends on sensor and linearization.	
	-99999 to +99999	End value of display range for standard signals
Lead wire resistance	0 Ω	The lead wire resistance is entered here with a two-wire circuit.
Ext. compensation temperature	No selection Analog selector	- The measurand used to record the cold-junction temperature is set here.
	Fixed compensation temperature	0 to 50 to 100 °C If the cold junction has a fixed temperature, this is entered here.
KTY at 25 °C/77 °F	0 to 2000 to 10000 Ω	Basic resistance of a KTY probe at 20 °C
Resistance measuring range	0 to 400 Ω	The following measuring ranges are available for a customer-specific linearized resistance measurement
	0 to 4000 Ω	

Linearization

Linearization is dependent upon the probe that is connected (measuring probe).

The predefined linearizations can be supplemented with **customer-specific linearization**.

⇒ Setup program:

SETUP ONLY > CUSTOMER-SPECIFIC LINEARIZATION

Measuring value offset, measuring value factor

The value for the measuring value offset provides parallel translation of all measured values and the value for the measuring value factor influences the increase in the values displayed.

Filter time constant

The filter time constant adjusts the digital input filter (2nd order filter). If the input signal changes suddenly, approx. 26 % of the change is recorded following a period that corresponds to the filter time constant (2× filter time constant: approx. 59 %; 5× filter time constant: approx. 96 %). A large filter time constant means: high attenuation of interference signals, slow reaction to the actual value display, low limit frequency (low-pass filter).

Scaling start, end

The maximum measuring range limits are displayed here, depending on the probe selected and the linearization. These limits only affect the recording. If, for example, the scaling end for a Pt100 is reduced from 850 °C to 400 °C, the recording only displays values up to 400 °C.

12 Configuration

Lead wire resistance

On connecting a RTD temperature probe in a two-wire circuit, longer lines may lead to measuring errors. This value is used to compensate the resistance of the probe line and depends on the line length. Enter the ohmic resistance of the probe line here to achieve the best possible temperature measurement.

12.5.1 Alarms

Limit value monitoring with one or two alarms and various alarm types can be activated for each analog input. In addition, this function is required in order to trigger the collective alarm of the controller module if the event of deviation above or below the measuring range (out of range).

This limit value monitoring is available in addition to the functions described in Chapter 12.9 "Limit value monitoring", page 100 and is independent of these.

Setup dialog

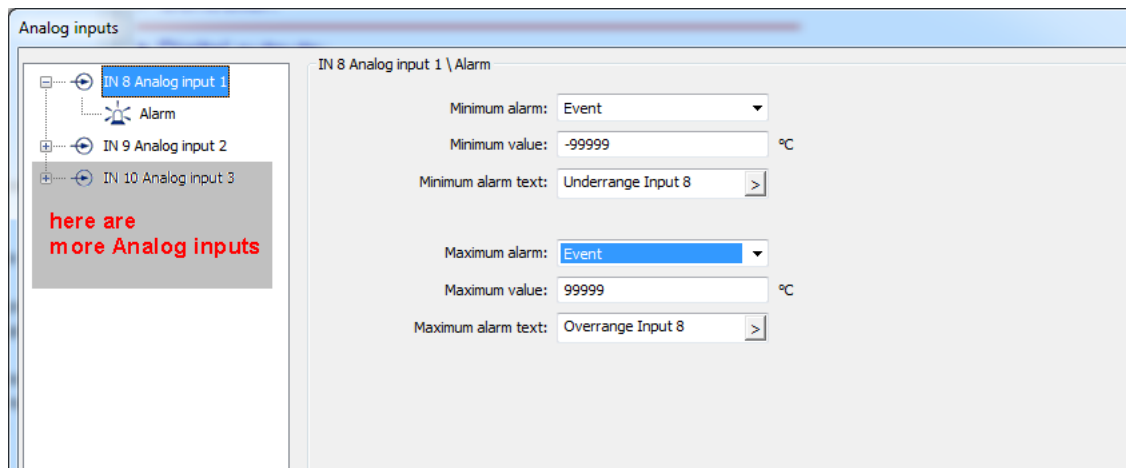

Parameter

Parameter	Selection/settings	Description
IN 8 Analog input 1, IN9 Analog input 2		
Minimum alarm	Off Alarm Event	Monitoring is not active. Alarm results in an entry in the alarm list. Alarm results in an entry in the event list.
Minimum value	-99999 to 0 to +99999	Limit value at which an alarm is issued.
Minimum alarm text	Underrange AE1	Text which is entered into the alarm or event list in the event of deviation.
Maximum alarm	Off Alarm Event	Monitoring is not active. Alarm results in an entry in the alarm list. Alarm results in an entry in the event list.
Maximum value	-99999 to 0 to +99999	Limit value at which an alarm is issued.
Maximum alarm text	Overrange AE1	Text which is entered into the alarm or event list in the event of deviation.

12.6 Controller1, 2

Two controllers (controller channels) are available. The parameters listed here can be configured independently of each other for controller 1 to controller 2.

12.6.1 Controller configuration

The controller type, the control direction, the output level for changeover to manual mode and for deviation above or below the measuring range, as well as the output level standardization and the deadband width are specified here.

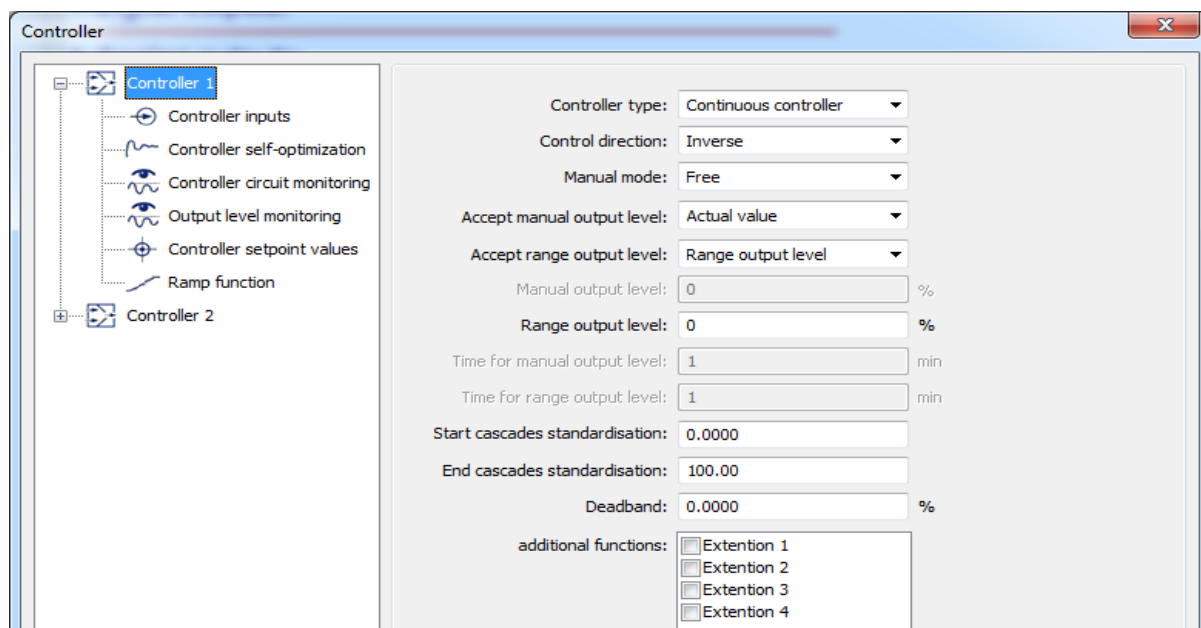

Setup dialog



Parameter

Parameter	Selection/settings ¹	Description
Controller 1, Controller 2		
Controller type	Off Two-state controller Three-state controller Modulating controller Continuous controller Position controller	Controller channel is switched off (default setting for Controller 2) Controller with a switched output (default setting for controller 1) Controller with two continuous or switched outputs (for example, for heating/cooling) Controller with two switched outputs (for motor actuator) Controller with a continuous output (analog signal) Continuous controller with integrated position controller (for motor actuator)
Control direction	Direct (2) Inverse (1)	The controller output level is positive if the actual value is greater than the setpoint value (cooling). The controller output level is positive if the actual value is smaller than the setpoint value (heating).

12 Configuration

Parameter	Selection/settings ¹	Description
Manual mode 	Enabled Disabled	Manual mode possible on the device Manual mode disabled
Y in manual mode		Defines the output level (%) that the controller should adopt after switching to manual mode.
	Y manual mode Current value Average value	The value set below for Y manual mode is adopted. The current controller output level before switching to manual mode is adopted. The average value calculated using the set time below is adopted.
Y with error		Defines the output level (in %) that the controller should display, if one of the analog values relevant for the controller is invalid (incorrect actual value, setpoint value, output level feedback, etc).
	Y substitute value Current value Average value	The Y substitute value set below is adopted. The current output level before deviation above or below the measuring range is adopted. The average value calculated using the set time below is adopted.
Y manual mode	0 to 100 %	
Y substitute value	0 to 100 %	
Time for manual average value	1 to 3600 min	Time for the average value when "Y in manual mode" average value is set
Time for substitute average value	1 to 3600 min	Time for averaging of values if the "Y with error" average value is set
Start of cascade standardization	0 to 100 %	The output level can be standardized here (only for cascade controllers).
End of cascade standardization	0 to 100 %	
Deadband (neutral zone) 	0.00 to 100 %	Output level movements within the deadband are suppressed, for example by noisy signals. The deadband is only effective for controller structures with I-component.
Additional functions not selected (empty)		
(only setup)	<input type="checkbox"/> Expansion 1 <input type="checkbox"/> Expansion 2 <input type="checkbox"/> Expansion 3 <input type="checkbox"/> Expansion 4	Reserved functions for service

¹ Bold: default setting

Control direction

Is set inversely by default (1) for heating mode.

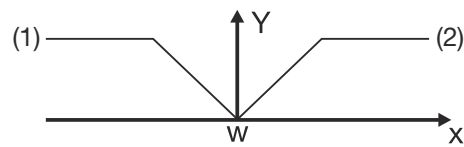

Manual mode

If the setting is disabled, manual mode is not possible on the device and the button for manual mode will be grayed out.

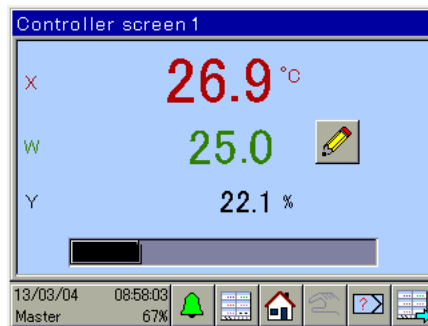

Deadband

Default is 0, i.e. no distance between heating and cooling contact.

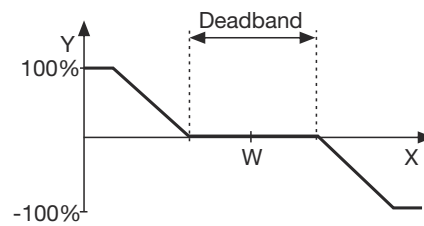

12 Configuration

12.6.2 Controller inputs

The analog inputs for the controller are configured in this menu – including the signals for switching off the controller and switching on the parameter block – as well as the parameters for manual mode.

Setup dialog

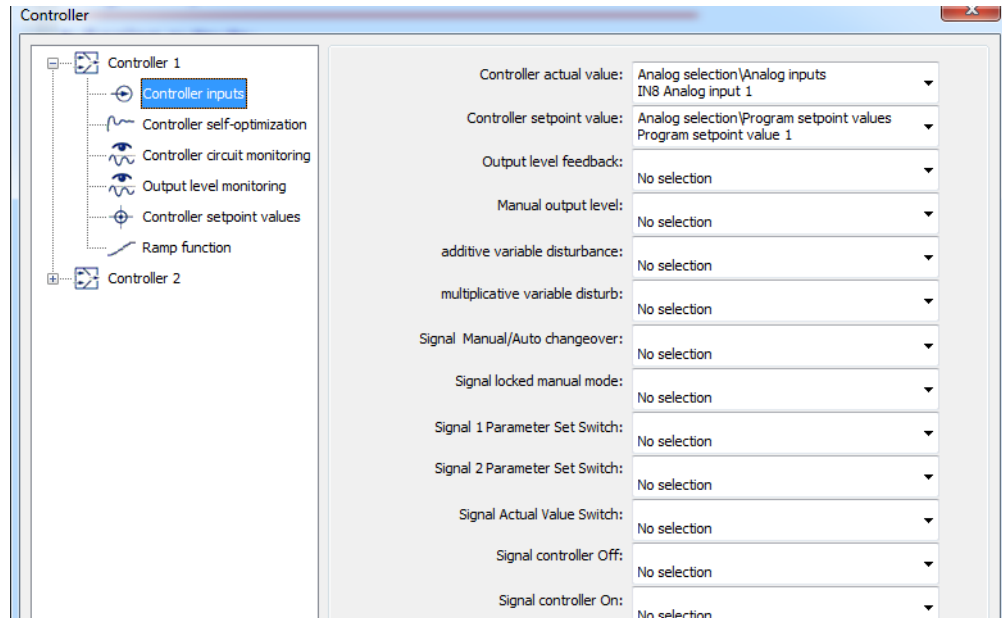

Parameter

Parameter	Selection/settings	Description
Controller 1, Controller 2		
Controller actual value	IN8 analog input 1 Analog selector	Analog signal for actual value
Controller setpoint value	Setpoint specification for Controller 1 Analog selector	Analog signal for setpoint value
Output level feedback	No selection	Analog signal for output level feedback
Manual output level	Analog selector	Analog signal for manual output level
Additive variable disturbance		Analog signal for additive variable disturbance
Multiplicative variable disturbance		Analog signal for multiplicative variable disturbance

Parameter	Selection/settings	Description
Manual signal/auto-switching	No selection	This signal switches between manual mode and automatic mode.
Locking signal for manual mode	Digital selector	This signal locks manual mode
Signal 1 Parameter block switching	Digital selector	The parameter blocks entered in the Chapter 11.3 "Controller/parameter blocks", page 58 are switched using both these signals.
Signal 2 Parameter block switching		
Signal for actual value switching 		
Controller signal off	Digital selector	The controller can be switched to On or Off using this signal.
Controller signal on		

Actual value switching

Provided that no signal is selected for switching the actual value, the actual values set from the analog selector for the controller configuration are active. If, however, a signal is set for switching the actual value, then the High signal level (logic "1"), is switched to the actual value outlined in red.

Controller 1 is then linked to IN9 (analog input 2) and Controller 2 to IN10 (analog input 3).

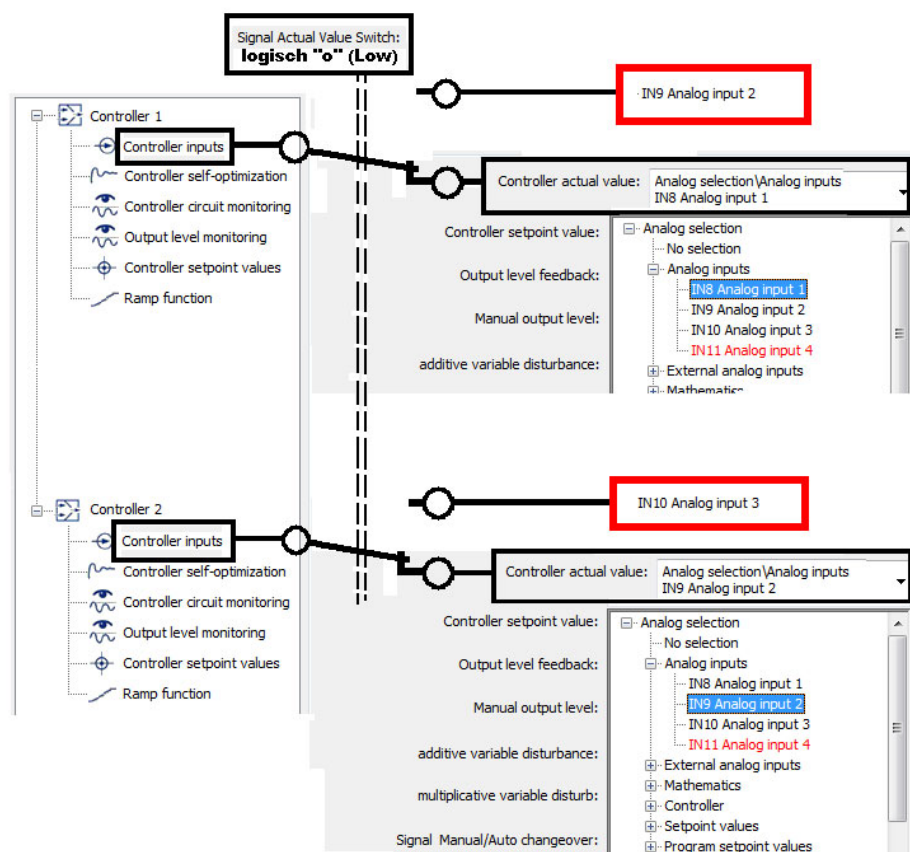

12 Configuration

12.6.3 Self-optimization controller

Self-optimization determines the optimum controller parameters for a PI or PID controller.

Setup dialog

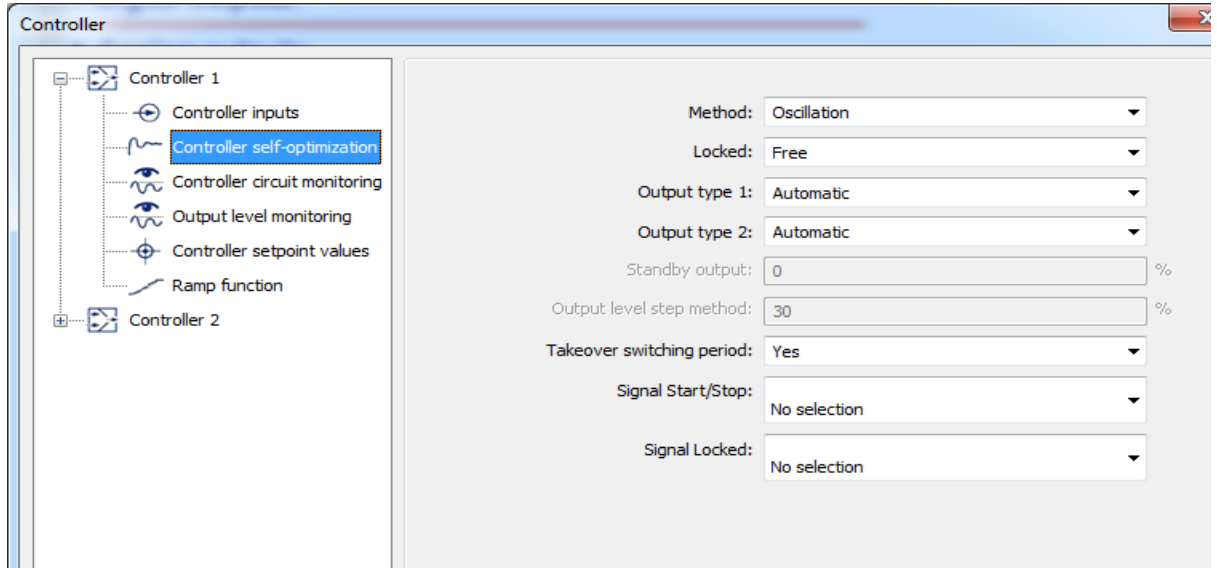

Parameter

Parameter	Selection/settings ¹	Description
Method 	Oscillation Step response	Oscillation method Step response method
Lock	Enabled Disabled	Self-optimization can be started on the device Self-optimization is disabled
Exit type 1, 2 	Automatic Relay Solid state, logic analog	Output level is recognized automatically. Output level is displayed using the relay... ... using the solid state relay or digital signal... ... using the analog output.
Standby output	0 to 100 %	
Output level for step method	0 to 30 to 100 %	Output level for step response level
Acquisition of switching period (Cy)	Yes No	Cy is detected during self-optimization Cy is not detected
Signal start/stop	No selection Digital selector	Start/stop signal for self-optimization
Locking signal	No selection Digital selector	Signal for locking self-optimization

¹ Bold: default setting

Method

The standard method is the oscillation method, whereas the step response method is used specifically in the plastics industry.

With the oscillation method, the output level is set alternately to 100 % and 0 %, which produces oscillation of the control variable. With the step response method, a step of a specified size is made from the standby output. In both cases, the controller determines the optimum controller parameters from the response of the actual value.

⇒ Chapter 12.6.3 "Self-optimization controller", page 82 and following pages

Optimization according to the oscillation method or Optimization according to the step response method

Exit type 1, 2

The cycle time is calculated on the basis of the type of controller output.

Optimized controller parameters

With both self-optimization methods, certain parameters are optimized according to the configured controller type and configured parameters. The controller structure is derived from the type of the optimized parameters: Proportional band X_p (P component), derivative time T_v (D component), and reset time T_n (I component).

The cycle time C_y and the filter time constant dF are also optimized.

Configured controller type	Configured parameter	Optimized parameter	Optimized controller structure
Two-state controller	$X_{p1} = \text{any};$ $T_{v1} = 0; T_{n1} > 0$	$X_{p1}, T_{n1}, C_{y1}, dF$	PI
	All other settings	$X_{p1}, T_{v1}, T_{n1}, C_{y1}, dF$	PID
Three-state controller	$X_{p1} = X_{p2} = \text{any};$ $T_{v1} = 0; T_{n1} > 0$	$X_{p1}, X_{p2}, T_{n1}, C_{y1}, C_{y2}, dF$	PI
	All other settings	$X_{p1}, X_{p2}, T_{v1}, T_{n1}, C_{y1}, C_{y2}, dF$	PID
Modulating controller	$X_{p1} = \text{any};$ $T_{v1} = 0; T_{n1} > 0$	X_{p1}, T_{n1}, dF	PI
	All other settings	$X_{p1}, T_{v1}, T_{n1}, dF$	PID
Continuous controller	$X_{p1} = \text{any};$ $T_{v1} = 0; T_{n1} > 0$	X_{p1}, T_{n1}, dF	PI
	All other settings	$X_{p1}, T_{v1}, T_{n1}, dF$	PID
Position controller	$X_{p1} = \text{any};$ $T_{v1} = 0; T_{n1} > 0$	X_{p1}, T_{n1}, dF	PI
	All other settings	$X_{p1}, T_{v1}, T_{n1}, dF$	PID

For first-order control paths, the parameters required for the PI controller structure are optimized, independently of the configured parameters.

Error handling

If the actual value deviates above or below the measuring range during self-optimization, self-optimization is aborted. In this case, the configured parameters are not changed.



WARNING!

During self-optimization according to the oscillation method, output level limits Y_1 and Y_2 are not active for switched outputs or solid state outputs.

The output level may exceed or fall below the set limits.

It must be ensured that this does not result in damage to the plant.

12 Configuration



NOTE!

Optimization must be performed under genuine operating conditions and requires a closed control loop, whose actuator influences the actual value (heating controlled by relay output). It can be performed as many times as required.

Start of self-optimization

Self-optimization can be started using any signal from the digital selector. Any other signal from the digital selector can be used to abort (stop) autotuning.

Optimization according to the oscillation method

In the case of a large control deviation between the setpoint value and actual value (for example, in the startup phase), the controller determines a switching line around which the control variable performs a forced oscillation during self-optimization. The switching line is determined so that the actual value does not exceed the setpoint value if possible.

In the case of minor control deviation (for example, if the control loop is in a steady state during operation), oscillation is forced around the setpoint value. Here, the setpoint value is exceeded in any case.

The controller automatically chooses between two procedures depending on the extent of the control deviation:

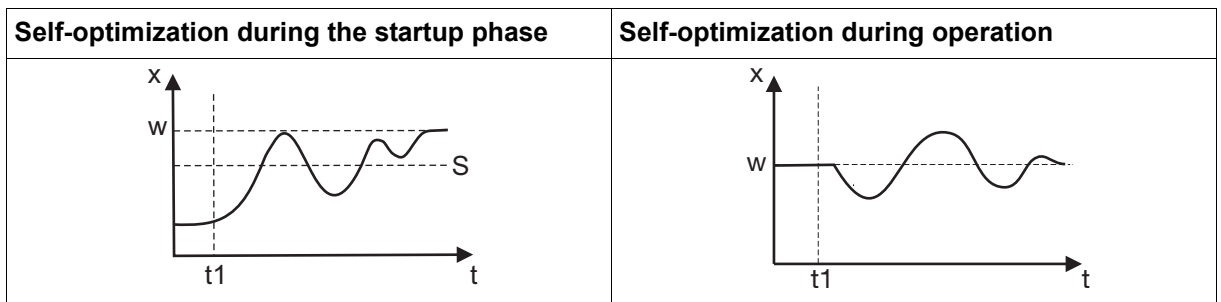

x Actual value
S Switching line

w Setpoint value
t1 Start of self-optimization

Optimization according to the step response method

Initially, a configurable standby output is produced until the actual value "settles" to a constant. This is automatically followed by a configurable output level step (step size) to the control path.

Main applications of the step response method:

- Optimization immediately after "power on" during startup (considerable time saving, standby output setting = 0 %)
- Control path does not oscillate easily (for example, extremely well insulated furnace with low losses, long oscillation period)
- Actual value must not exceed setpoint value

If the output level is known for the corrected setpoint value, overshooting is prevented with the following setting:

Standby output + step size \leq output level in corrected state

The progression of the output level and actual value depends on the status of the process at the point when self-optimization starts:

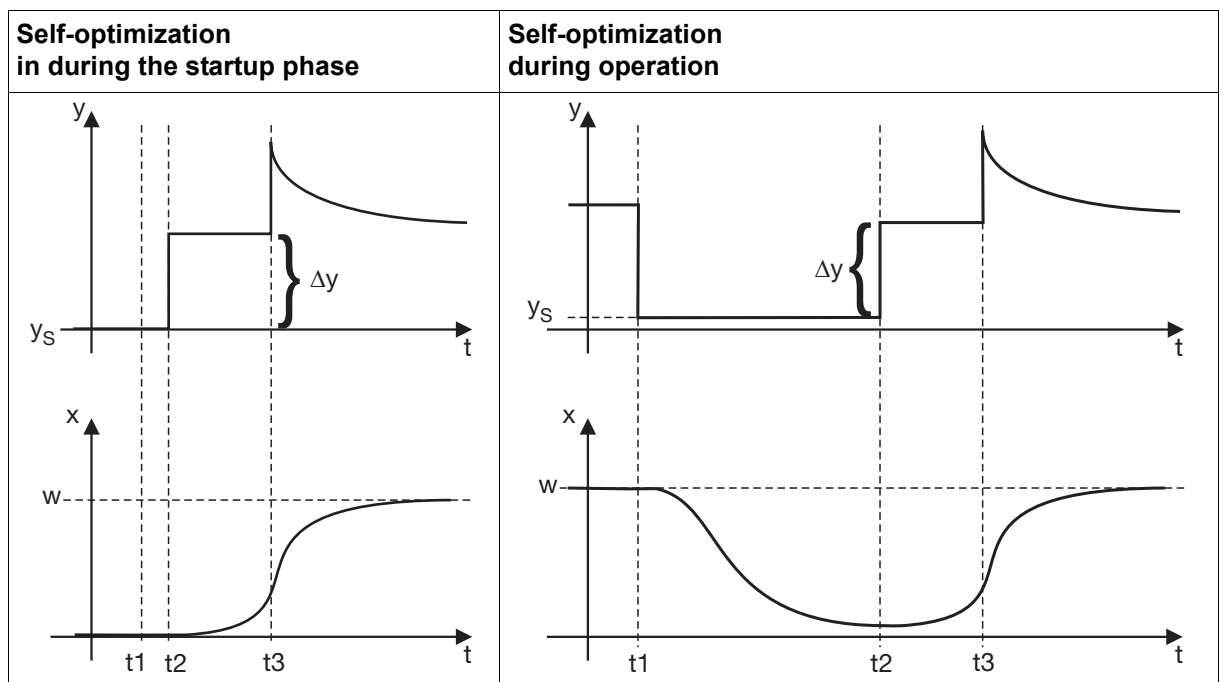

y Output level
 y_s Standby output
 x Actual value
 w Setpoint value

Δy Step size
 t1 Start of self-optimization
 t2 Point of output level step
 t3 End of self-optimization

12 Configuration

Checking the optimization

You can check for optimum adjustment of the controller to the control path by recording the startup process (with "Startup", for example) with a closed control loop. The diagrams below indicate possible incorrect adjustments and correction of these.

Here, the guiding behavior of a third-order control path for a PID controller is recorded as an example. The procedure for setting the controller parameters can also be applied to other control paths.

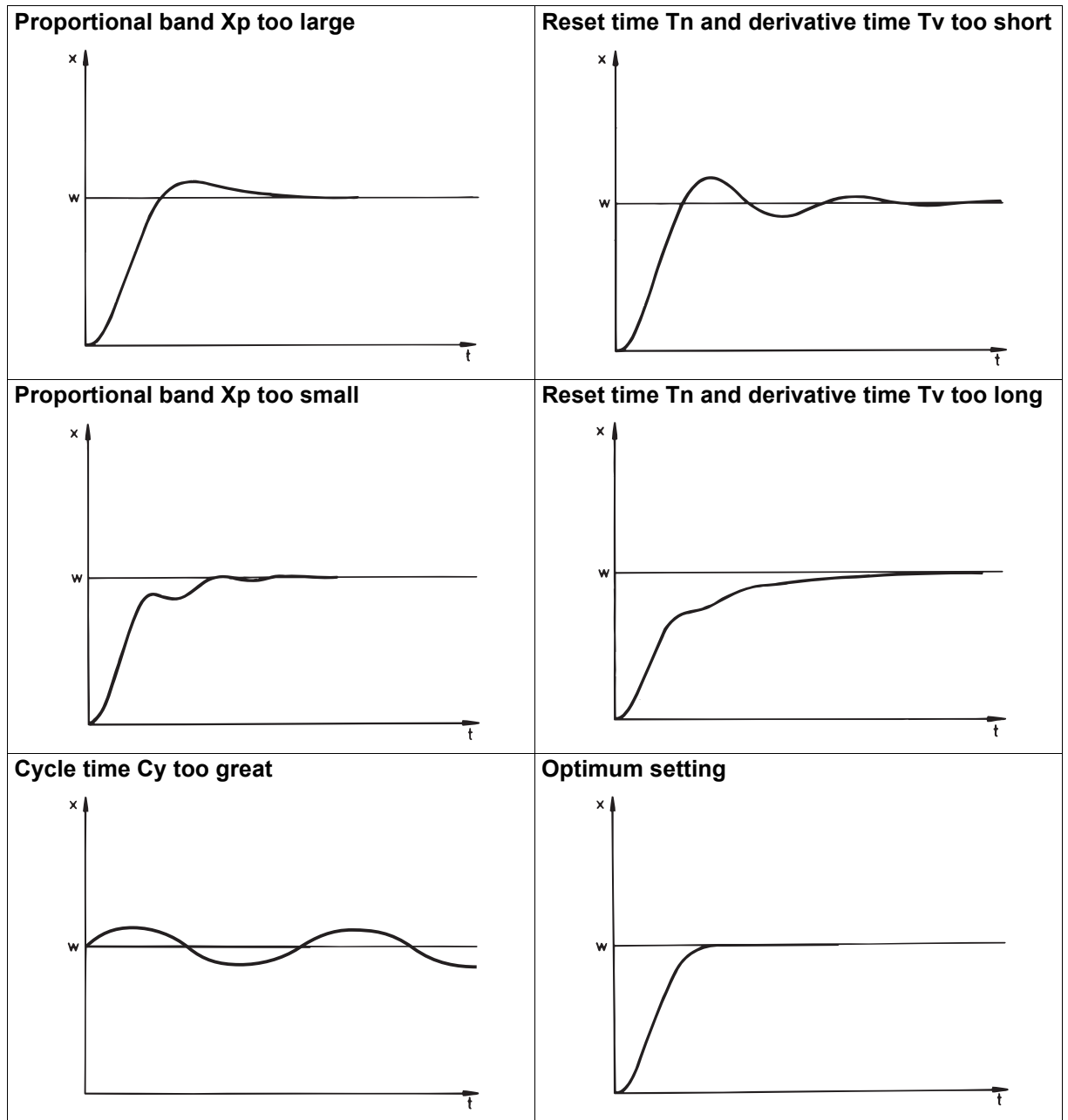

12.6.4 Control loop monitoring

Control loop monitoring monitors the control behavior during startup of a plant and in the event of a setpoint value step by analyzing the change of the actual value during an output level change. An alarm is issued if the actual value does not respond according to the specifications. The alarm signal is available from the digital selector and can be processed further at any time.

Setup dialog

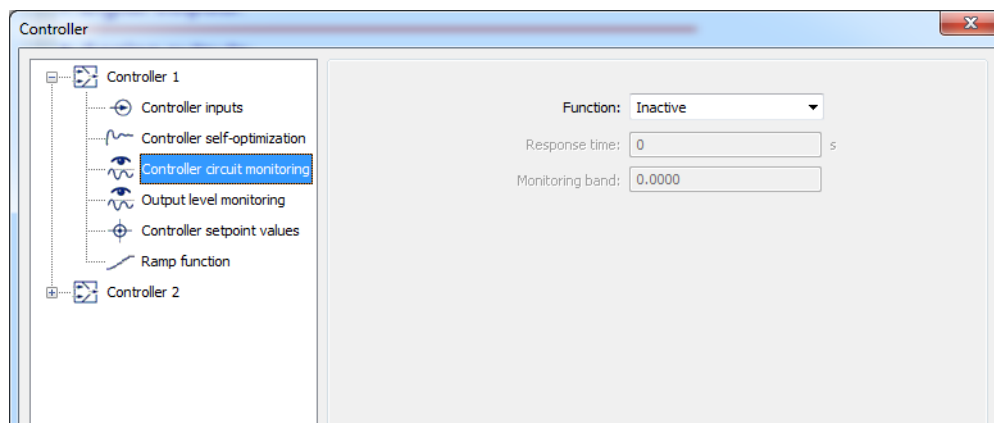

Parameter

Parameter	Selection/settings	Description
Function &	Inactive	Control loop monitoring is generally not permitted
	Active	Control loop monitoring is generally permitted
Response time	0 to 1999	Time period in which the actual value must leave the monitoring band. "0 s" setting means: Response time = reset time T_n
Monitoring band	0.0000 to 1999	Monitoring band width that must leave the actual value within the response time "0" setting means: Monitoring band = $0.5 \times$ proportional band (X_p)

12 Configuration

Description of the function

Monitoring starts as soon as the maximum output level is produced in heating mode (see example) or as soon as the minimum output level is produced in cooling mode. Starting from this point, the actual value must leave the monitoring band – the range around the current value at the start of monitoring – within the response time. If it is not, an alarm is triggered.

On leaving the monitoring band, the actual value at the time is used as a reference value for a new monitoring band. The response time starts over.

Monitoring ends as soon as the maximum or minimum output level is no longer produced.

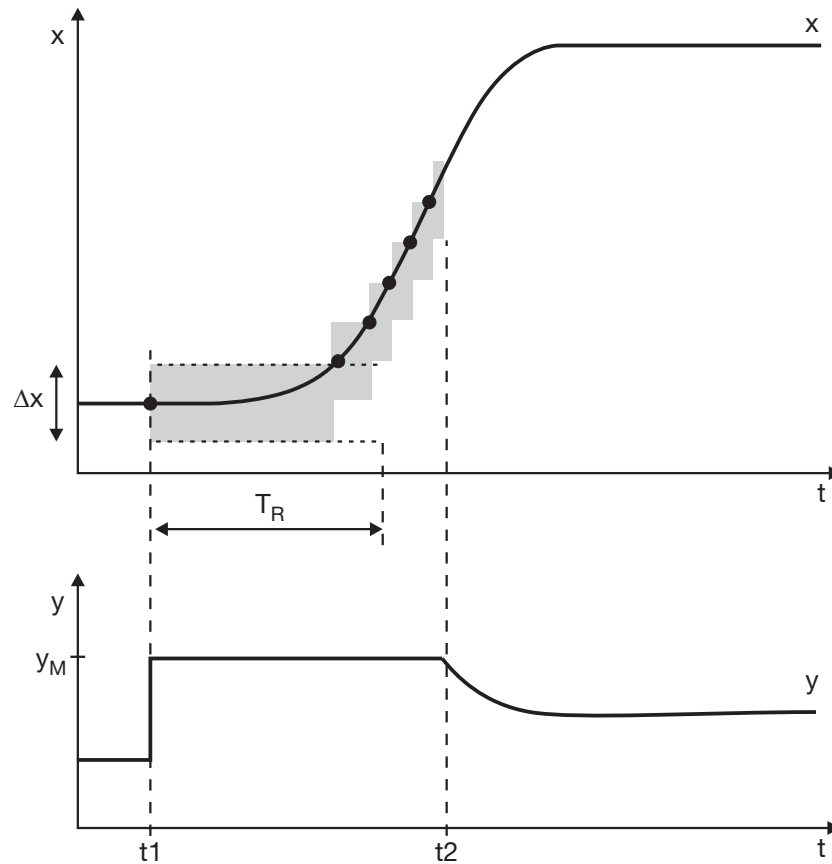

x Actual value
 y Output level
 t1 Start of monitoring
 t2 End of monitoring

Δx Monitoring band
 y_M Max. output level (for example, 100 %)
 T_R Response time

12 Configuration

If the actual value does not leave the monitoring band within this timeframe, an alarm signal is generated. The alarm signal is maintained for as long as the maximum or minimum output level is produced and the actual value is within the monitoring band.

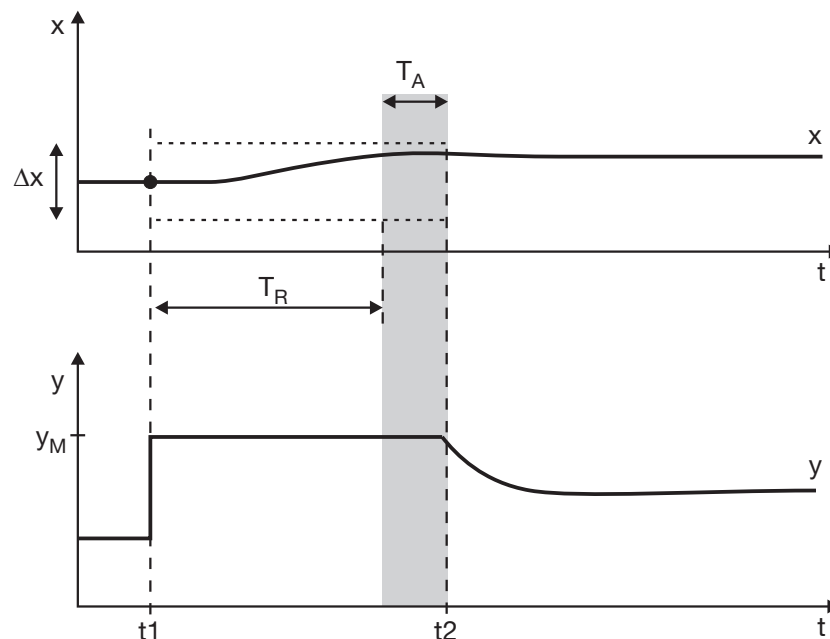

x	Actual value	Δx	Monitoring band
y	Output level	y_M	Max. output level (for example, 100 %)
t1	Start of monitoring	T_R	Response time
T_A	Alarm period	t2	End of monitoring

An alarm may be caused by:

- Partial or total failure of heating elements or other parts in the control loop
- Reversal of the control direction (for example, "cooling" instead of "heating")

12 Configuration

12.6.5 Output level monitoring

Output level monitoring monitors the output level in the corrected state. The output level must be within a definable range around a mean output level. If it is not, an alarm is issued.

The alarm signal is available from the digital selector and can be processed further at any time.

Setup dialog

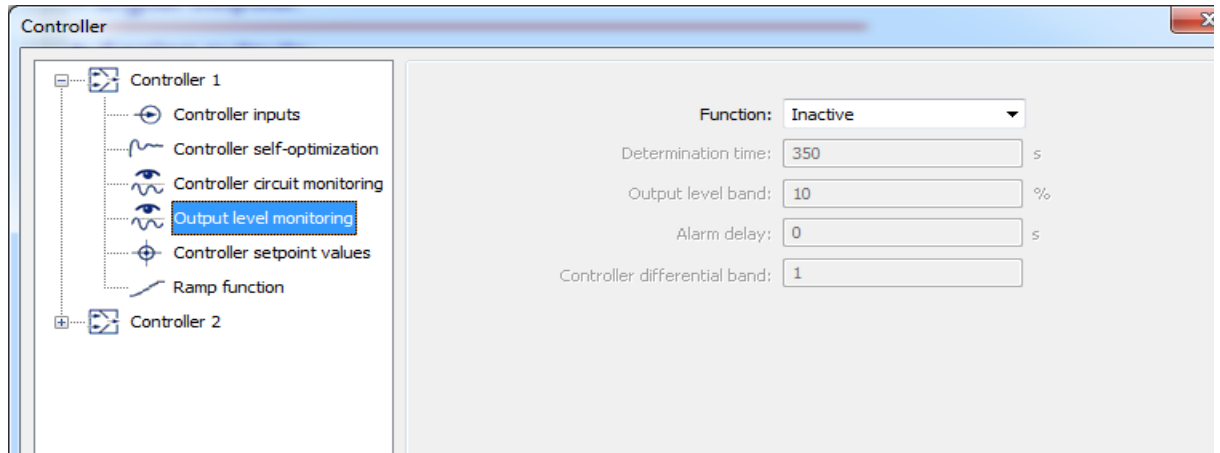

Parameter

Parameter	Selection/settings	Description
Lock	Inactive	Output level monitoring generally not permitted
	Active	Output level monitoring generally not permitted
Determination time	0 s to 350 s to 9999 s	Calculation time for the mean output level
Output level band	0 % to 10 % to 100 %	Monitored output level band (admissible range around the mean output level)
Alarm delay	0 s to 9999 s	Delay time for alarm triggering
Controller differential band	0 to 1 to 1999	Controller differential band (admissible range around the actual value in corrected state)

Description of the function

Once the output level monitoring has been activated, determination of the mean output level starts as soon as the actual value is within the controller differential band. When the mean output level has been determined, the current output level must be within the monitored output level band. If it is not, an alarm is triggered.

In the event of a setpoint value change, the output level monitoring is temporarily deactivated until the actual value returns to the controller differential band. The mean output level is then determined again.

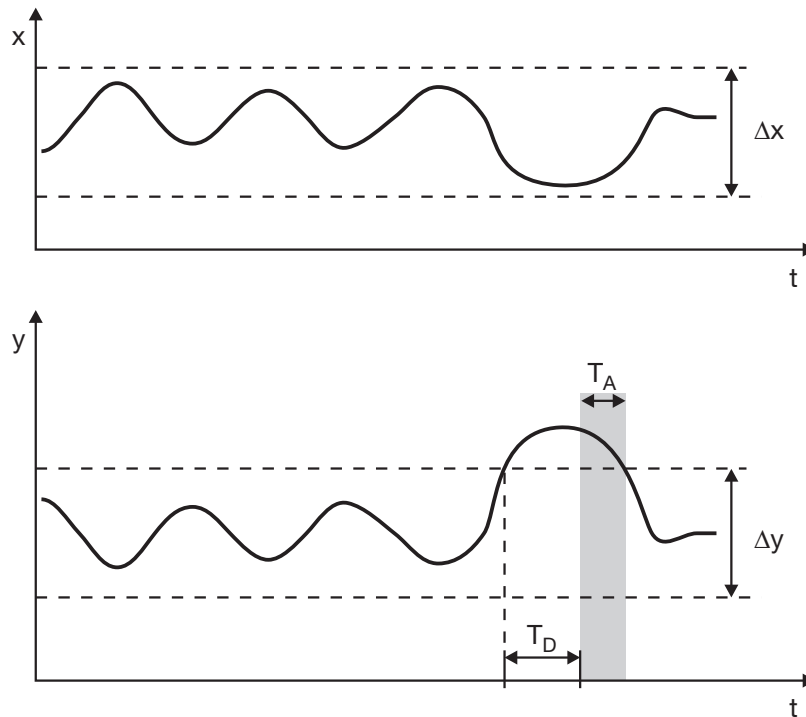

x Actual value
y Output level
 T_D Alarm delay

Δx Controller differential band
 Δy Monitored output level band
 T_A Alarm period

Application examples:

- Monitoring of signs of aging and faults on heating elements
- Reporting of faults during operation

Functional limitations

Output level monitoring is not active in the following cases:

- Proportional band $X_p = 0$
- Self-optimization active
- Manual mode
- Ramp function active
- Controller operating as program controller
- Modulating controller without output level feedback (or output level feedback in "out of range" state)
- Position controller with output level feedback in "out of range" status

12 Configuration

Parameter dimensioning

Appropriate dimensioning of parameters used for determining the mean output level is required for the output level monitoring to function correctly.

The **controller differential band** around the actual value defines the corrected state. It should be dimensioned so that it is adhered to during normal operation. The progression of the actual value can, for example, be recorded with the recording function on the device or with the startup function of the setup program. Determination of the mean output level starts when the actual value enters the control differential band. Calculation of the mean output level starts over if there is temporary deviation from the control differential band during output level determination or if the setpoint value is changed by more than $0.5 \times$ control differential band Δx .

An average output level is calculated over the **determination time** by a sliding average. The time selected should be sufficiently long to ensure as accurate a calculation as possible. A waiting time of $0.5 \times$ reset time T_n is connected to the determination time, during which time the actual value and output level are checked to see if they are within in the specified limits. If the limits are exceeded, the calculation will restart. Once the calculation is successful, the output level monitoring will be activated.

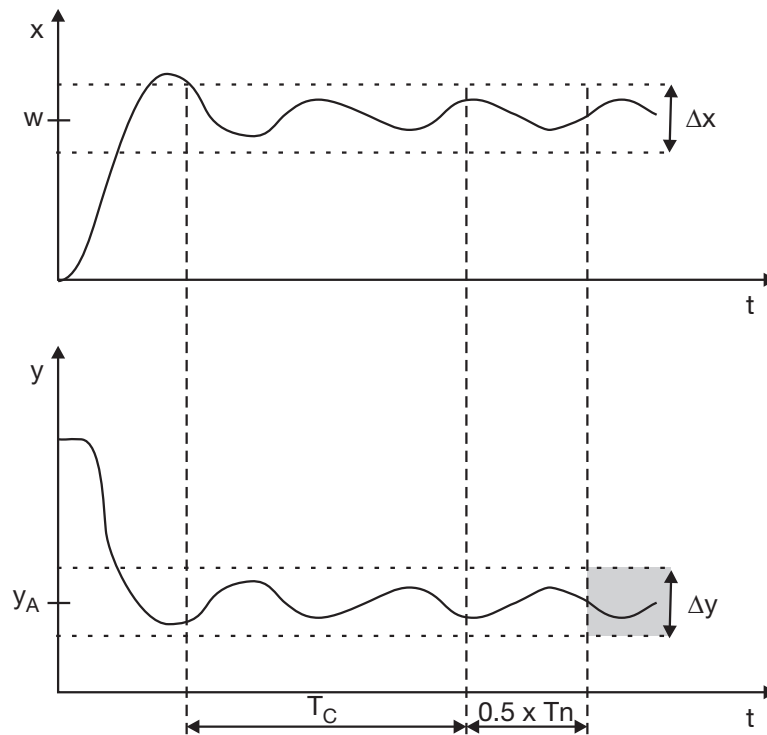

- | | | | |
|----------------|--------------------|----------------|------------------------------|
| x | Actual value | w | Setpoint value |
| y | Output level | y _A | Average output level |
| T _C | Determination time | T _n | Reset time |
| Δy | Output level band | Δx | Controller differential band |

12.6.6 Controller setpoint values

With this separate setpoint value function, the setpoint values and the ramp function can be configured flexibly for both controller channels (Controller 1 to 2).

Up to four setpoint values are available for each controller channel and can be switched using two digital signals.

The analog signal for the setpoint value (external setpoint value 1 to 2) is selected from the analog selector. This signal can be charged with a correction value (setpoint value 1 to 4). If no analog signal is selected (inactive), the correction value acts as a stable setpoint value.



NOTE!

The active setpoint value is not automatically used as a setpoint value for the controller channel; it must first be assigned in the controller configuration (see Chapter 12.6.2 "Controller inputs", page 80).



NOTE!

If an analog signal is used as a setpoint value without a correction value, it can also be directly assigned in the controller configuration. In this case, setpoint value limitation, setpoint changeover, and the ramp function are not available.

Equally, a fixed setpoint value can be assigned directly in the controller configuration (see Chapter 12.6.2 "Controller inputs", page 80).

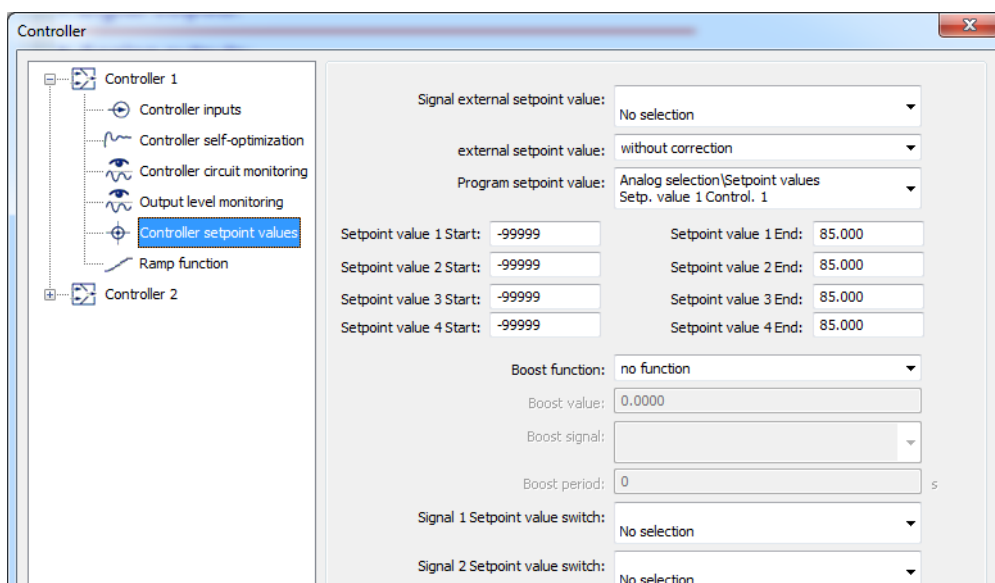

Setup dialog



Parameter

Parameter	Selection/settings	Description
Signal for ext. setpoint value	No function	Signal source for ext. setpoint value.
	Analog selector	
External setpoint value	No offset	There is no ext. setpoint offset
	Offset	The external setpoint value is added to the internal setpoint value of the fixed setpoint controller or program controller.

12 Configuration

Parameter	Selection/settings	Description
Program setpoint value 	Program setpoint value 1 Program setpoint value 2	The source for the program setpoint value is selected here for the active program controller.
Setpoint value 1 to 4 start	-99999 to +99999	Setpoint limit start
Setpoint value 1 to 4 end	-99999 to +99999	Setpoint limit end
Boost function &	No function	Boost function switched off
	Delta value	Setpoint value is increased by a Delta value.
	Percentage value	Setpoint value is increased by a percentage value.
Boost value	0.00 to 99999	Amount by which the setpoint value is increased (in K or % by the setpoint value)
Boost signal	No selection	-
	Digital selector	The boost function is switched on using this signal.
Boost duration	0 to 999	Duration of boost period (in s)
Signal 1 setpoint changeover 	No selection Digital selector	Signal 1 is selected here for the setpoint changeover for the fixed-setpoint controller.
Signal 2 setpoint changeover 		Signal 2 is selected here for the fixed-setpoint changeover

Program setpoint value

This setting is only available if the program controller is configured. The setpoint values can then be read off the program curves that are entered.

Boost function

The boost function is used to release tools in the plastics industry during the production process. The setpoint values for all heating zones are thereby increased by a specific Delta or percentage value for a specific time period.

Setpoint changeover

The setpoint values 1 to 4 for both fixed-setpoint controllers are located in the parameter level and can be entered as follows:

⇒ Chapter 11.4 "Setpoint values", page 62

Switching can be performed using digital signals from the digital selector.

Signal 2 (Bit 1) setpoint changeover	Signal 1 (Bit 0) setpoint changeover	Active setpoint value, Controller 1	Active setpoint value, Controller 2
0	0	Setpoint value 1	Setpoint value 1
0	1	Setpoint value 2	Setpoint value 2
1	0	Setpoint value 3	Setpoint value 3
1	1	Setpoint value 4	Setpoint value 4

12.6.7 Ramp function

The ramp function enables the setpoint value to be continually changed up to the ramp end value (active setpoint value).

A tolerance band can be set around the setpoint value curve to monitor the actual value. If the actual value deviates from the tolerance band, a digital signal (tolerance band signal) is activated.

Setup dialog

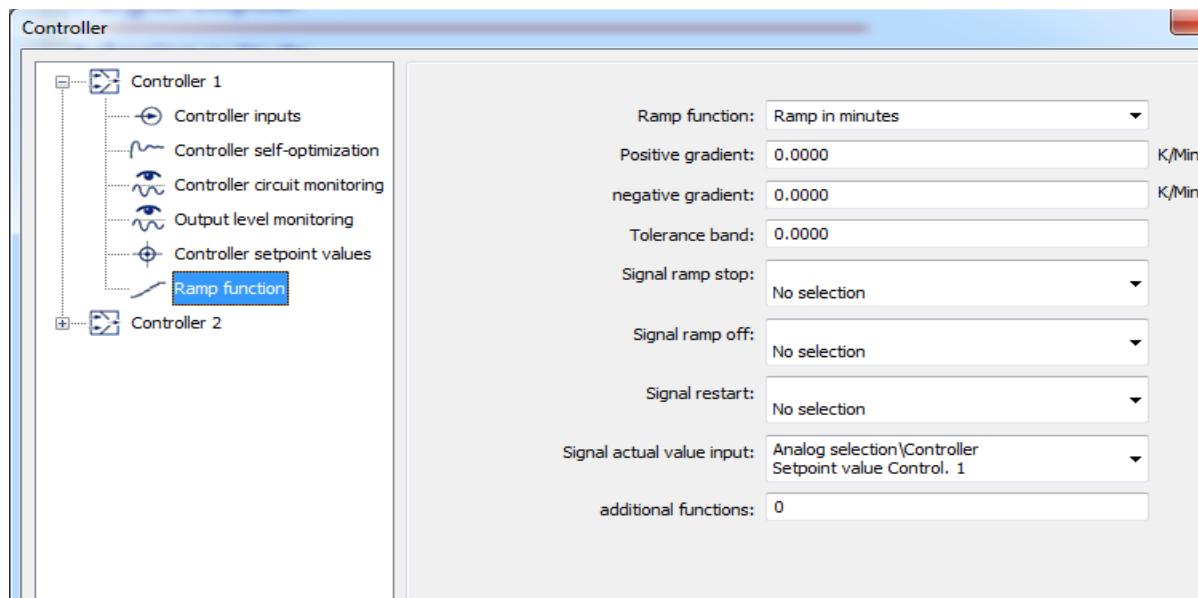

Parameter

Parameter	Selection/settings	Description
Ramp function 	Ramp off Ramp in minutes Ramp in hours Ramp in days	Ramp function switched off Ramp function switched on
Positive gradient	0.00 to 999.00	In the event of a setpoint value step, the ramp rises depending on the time unit that has been set.
Negative gradient	0.00 to 999.00	In the event of a setpoint value step, the ramp declines depending on the time unit that has been set.
Tolerance band 	0.00 to 999.00	The tolerance band monitors deviation of the actual value from the current setpoint value (tolerance band = admissible deviation)
Signal for ramp stop	No selection Digital selector	The ramp can be stopped with this signal (see t4 in image)
Signal for ramp off	No selection Digital selector	The ramp can be switched off with this signal

12 Configuration

Parameter	Selection/settings	Description
Restart signal	No selection Digital selector	The ramp can be restarted with this signal
Signal actual value input	Analog selector/Controller 1 Actual value for Controller 1	This actual value is monitored by the tolerance band
Additional functions (only setup)	0.00 to 999.00	Reserved functions for service

Ramp function

This function creates a ramp-like setpoint curve out of a step-like setpoint curve, where the rising and declining slopes can have different gradients.

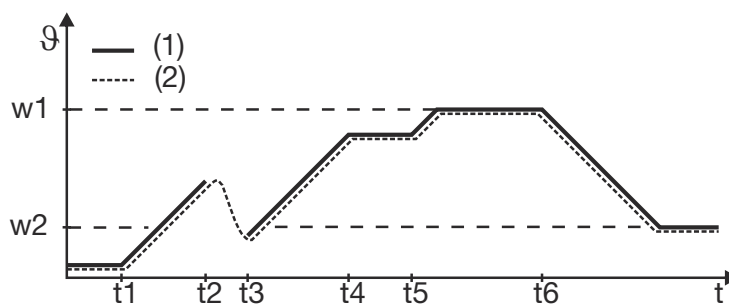

- $t1$ Power ON
 - $t2 \dots t3$ Power failure, manual mode, probe break
 - $t3$ Ramp start at current value
 - $t4$ to $t5$ Ramp stop by digital input
 - $t6$ Setpoint changeover to $w2$
- (1) Setpoint value
(2) Actual value

Tolerance band function

For a program controller/generator and ramp function, a tolerance band can be laid to monitor the actual value of the setpoint value curve. If the upper and lower limits are exceeded, a tolerance band signal is triggered, which can be processed further internally or issued via an output.

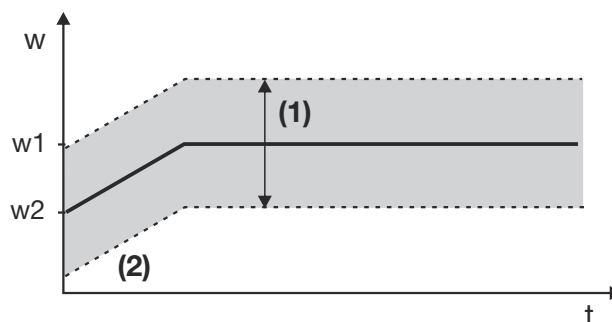

- (1) Tolerance band
- (2) Ramp

12.7 Digital outputs

Depending on how the expansion slots have been mounted, two fixed digital outputs called OUT1 and OUT2 and ten additional digital outputs (OUT3/4 to OUT11/12) are available.

Setup dialog

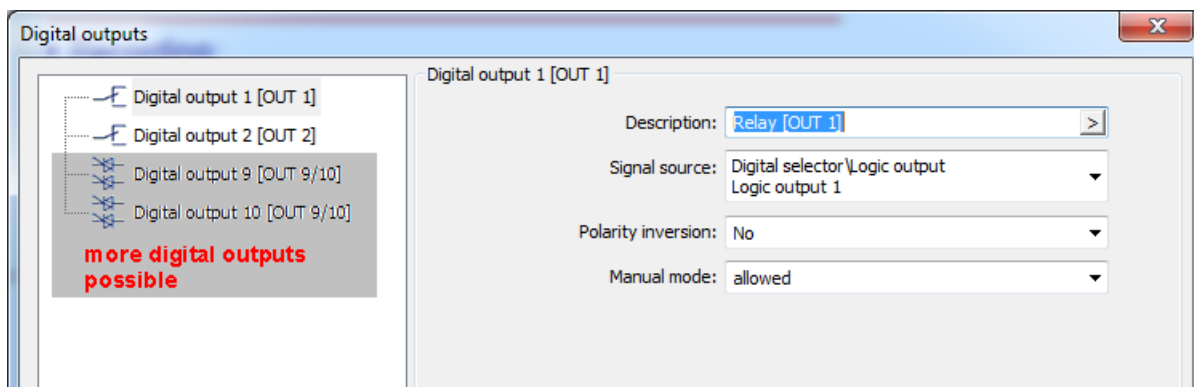

Parameter

Parameter	Selection/settings	Description
Designation	Relay [OUT 1]	(15 characters) of editable text For example, for the signal that is issued via the digital output.
Signal source	Digital selector/controller 1st output, Controller 1	This signal is issued at the digital output.
Inversion	No Yes	Switching behavior remains unchanged Inverts the switching behavior
Manual mode	Not permitted Permitted	Digital output can be edited in manual mode.
Designation	Relay [OUT 2]	Signal designation issued via the digital output. Inactive = output inactive
Signal source	Digital selector/controller 2nd output, Controller 1	This signal is issued at the digital output.
Inversion	No Yes	Switching behavior remains unchanged Inverts the switching behavior
Manual mode	Not permitted Permitted	Digital output can be edited in manual mode.

12 Configuration

12.8 Analog outputs

A maximum of three analog outputs can be configured as current or voltage outputs (standard signal) and are freely scalable.

Setup dialog

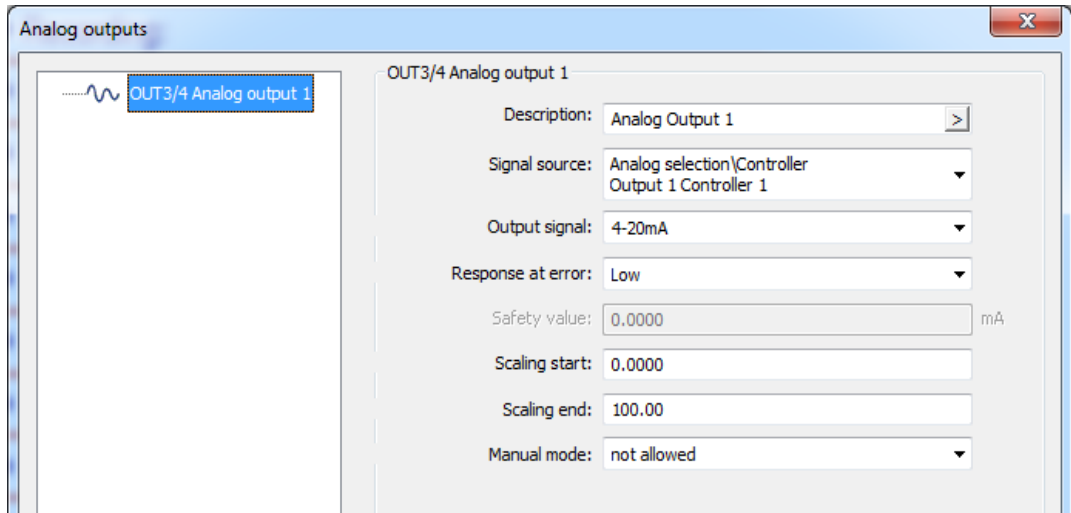

Parameter

Parameter	Selection/settings	Description
Designation	Analog output 1	(15 characters) of editable text for the signal issued via the analog output (for example, a math function event).
Signal source	No selection Analog selector	- This signal is issued via the analog output.
Output signal	0-10 V 0-20 mA 4-20 mA 2-10 V	
Signal in the event of an error	Low High Namur Low Namur High Frozen Substitute value	Lower unit signal limit is issued Upper unit signal limit is issued See table (limits according to Namur) See table (limits according to Namur) Retains the last valid values Issues the set substitute value
Substitute value	For example, 0 to 10 V	Substitute value which can be set within the output signal limits (for example, 0 to 10 V).
Scaling start	0.00 to 100.00	
Scaling end	100.00 to. 0.00	
Manual mode	Not permitted	Analog output not editable in manual mode
	Permitted	Analog output editable in manual mode.

Behavior on error

Limits according to NAMUR recommendation NE 43:

	Signal type 2 to 10 V	Signal type 4 to 20 mA
Measurement information M	1.9 to 10.25 V	3.8 to 20.5 mA
Failure information A for deviation below measured value/short-circuit ("NAMUR Low")	≤ 1.8 V	≤ 3.6 mA
Failure information A for deviation above measured value/probe break ("NAMUR High")	≥ 10.5 V	≥ 21 mA

Zero point and end value

A value range is assigned to the physical output signal by specifying the zero point and end value (scaling). The default setting corresponds to a value range of 0 to 100 (for example, an output level of 0 % to 100 % for a controller output).

If, for example, a temperature with a value range from 150 °C to 500 °C is issued via an analog output with signal type 0 to 20 mA, the zero point must be set to 150 (corresponds to 0 mA) and the end value must be set to 500 (corresponds to 20 mA).

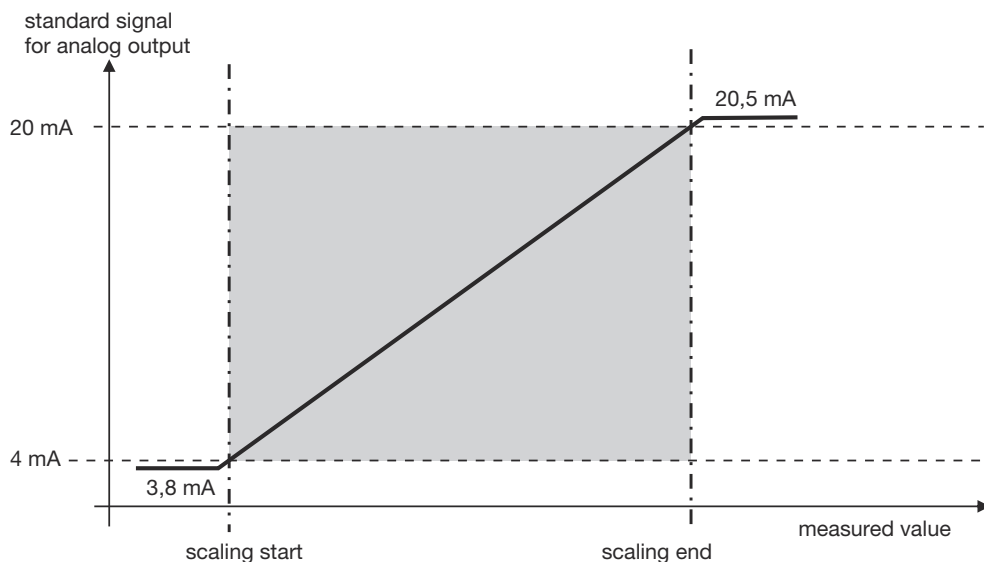

Status after change of configuration

Modified parameters are incorporated immediately.

Behavior after power on

During the initialization phase of the controller module, the output signal adopts a value of 0 % (in relation to the value range of the signal type).

Error handling

The behavior in the event of deviation above or below the measuring range (out of range) can be configured. The settings made there also apply for probe/conductor breaks or probe/conductor short-circuits. This results in a safe state for operation in the event of an error.

Error detection depends on the type of measuring probe (see technical data, measuring circuit monitoring).

12 Configuration

12.9 Limit value monitoring

One of eight alarm functions can be selected for all 12 limit value monitorings, to monitor a freely selectable input value (actual value) against a fixed limit values AF7 and AF8 or a limit value related to the setpoint value (setpoint value \pm limit value) (AF1 to AF6). Each limit value monitoring delivers an output signal that can be linked to or issued to a digital output.

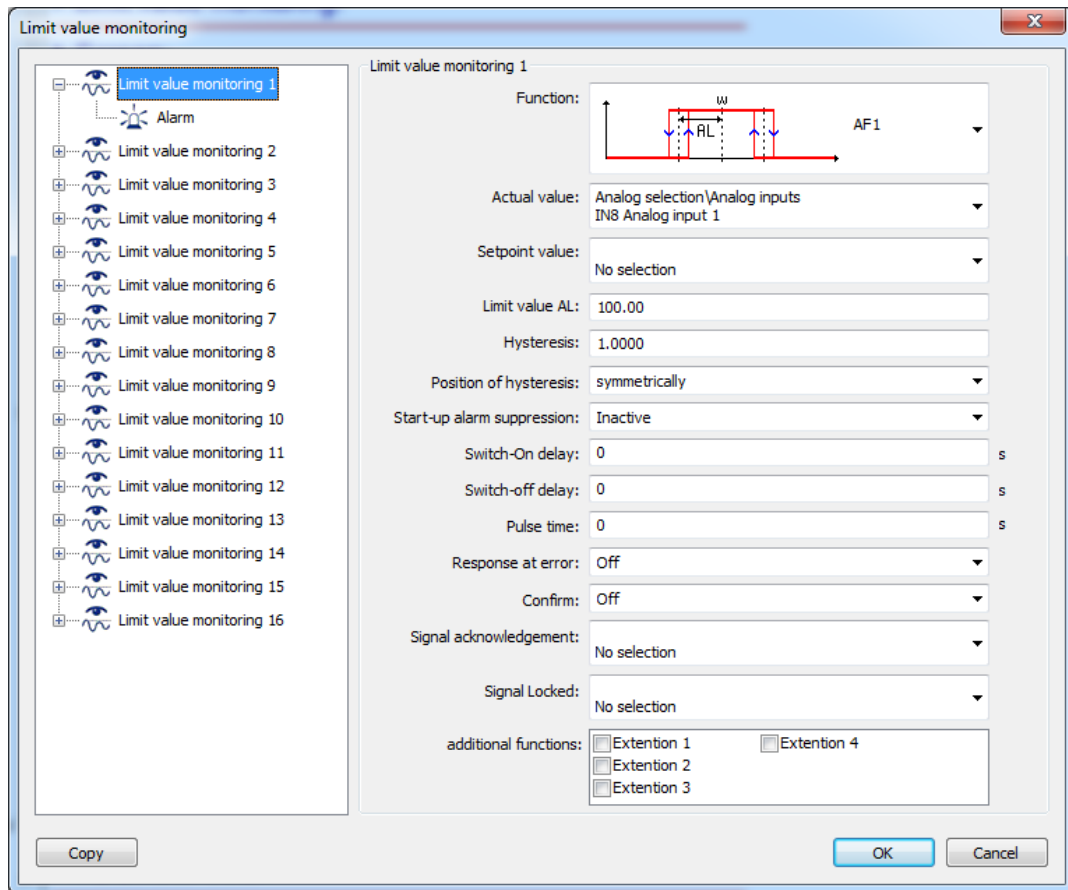

Setup dialog



Parameter

Parameter	Selection/settings	Description
Function	No function AF1 to AF8	Alarm function (AF 1 to 8) selectable
Actual value	No selection Analog selector	Analog signal to be monitored
Setpoint value	No selection Analog selector	Setpoint value w (reference signal for AF1 to AF6)
Limit value AL	0.0000 to 99999	- For AF1 to 6, in relation to a changing setpoint value w - For AF7 and AF8, in relation to a fixed limit value
Hysteresis	0.0000 to 1 to 9999.9	Switching distance between switch-on and switch-off

12 Configuration

Parameter	Selection/settings	Description
Position of hysteresis	Standard Non-standard left Non-standard right	Here you can adjust the setting for which side the hysteresis should be on.
Start-up alarm suppression 	Inactive	AF switching behavior is not suppressed
	Active	AF switching behavior is suppressed, provided that value has is not within the valid range.
Switch-on delay	0.0000 to 99999	After entering the AF event, the time for the switch-on delay begins to elapse. The AF output remains unchanged at first until the set time has completely elapsed and the AF event is relayed to the AF output. If the AF actual value leaves the "bad area" for the switch-on delay during this time, the count-down begins again for each new limit value violation.
Switch-off delay	0.0000 to 99999	Identical behavior as with switch-on delay, except that the AF switch-off process is delayed. Self-locking takes priority over the switch-off delay.
Pulse time	0.0000 to 99999	AF output is automatically deactivated after the pulse time. The output is only re-activated to the maximum level via the set pulse time after repeated deviation above or below the alarm values. Self-locking takes priority over the switch-off delay.
Signal in the event of an error		
	Off	AF output is switched off in the event of an error
	On	AF output is switched on in the event of an error
Self-locking 	Off	The alarm function is automatically reset following a limit value violation.
	"Inactive" status	Self-locking can only be acknowledged if the AF actual value is re-located in the valid range.
	"Active" status	Self-locking can always be acknowledged if it has been activated
Acknowledging self-locking	No selection	No acknowledgement possible
	Digital selector	This signal acknowledges self-locking.
Locking signal	No selection	This signal locks the alarm function.
	Digital selector	
Additional functions not selected (empty)		
(only setup)	<input type="checkbox"/> Expansion 1	Reserved functions for service
	<input type="checkbox"/> Expansion 2	
	<input type="checkbox"/> Expansion 3	
	<input type="checkbox"/> Expansion 4	

12 Configuration

12.9.1 Function and hysteresis

For the AF1 to AF6 alarm functions, the final limit value depends on the setpoint value – the entered limit value is added to or subtracted from the setpoint value. The AF7 and AF8 alarm functions work with a fixed limit value which corresponds to the limit value entered. Shown with the associated hysteresis functions (non-standard left, standard, non-standard right)

Limit value in relation to the setpoint value

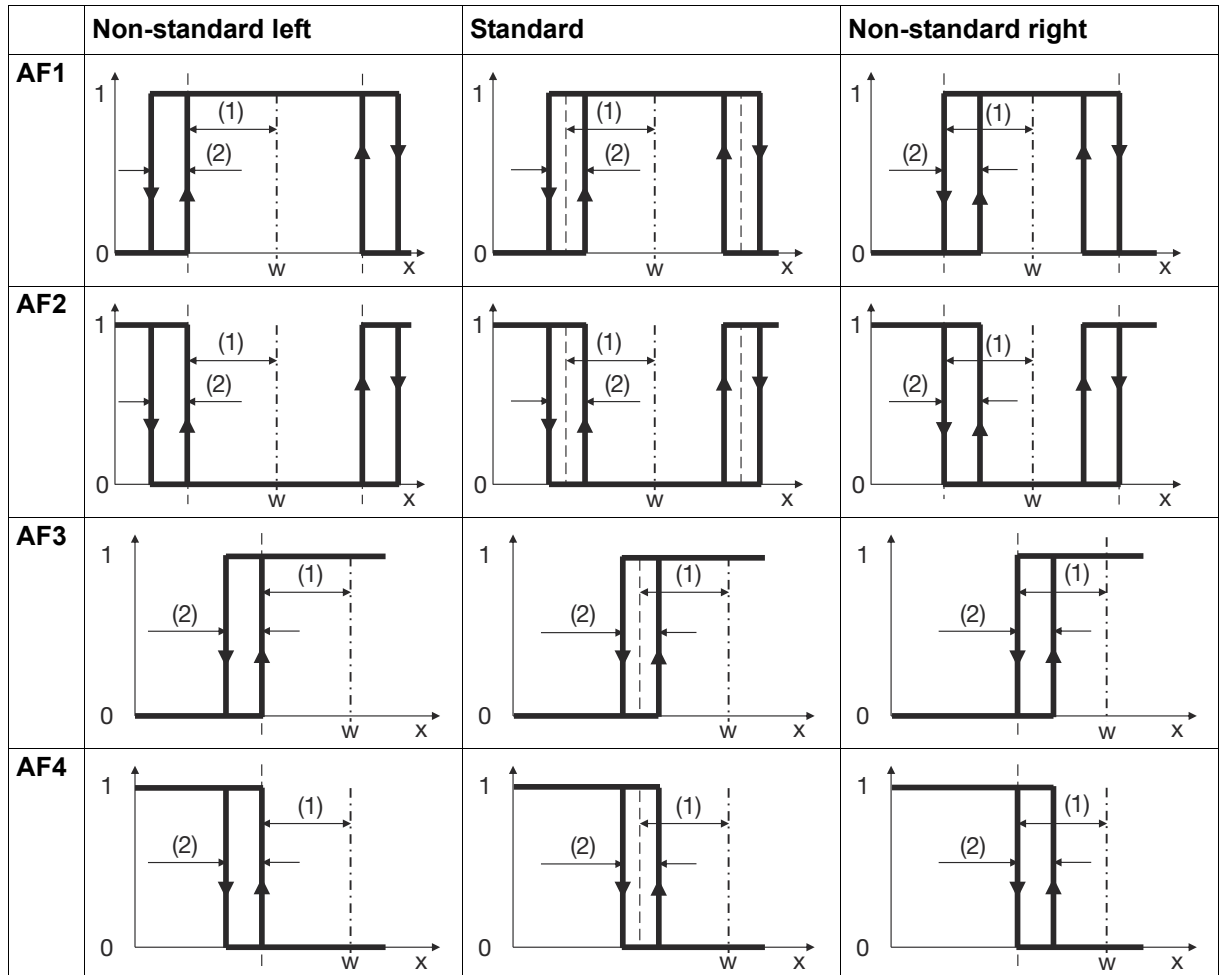

- 1 Output signal active
- 0 Output signal not active
- x Actual value
- w Setpoint value
- (1) Limit value (setpoint value distance)
- (2) Hysteresis

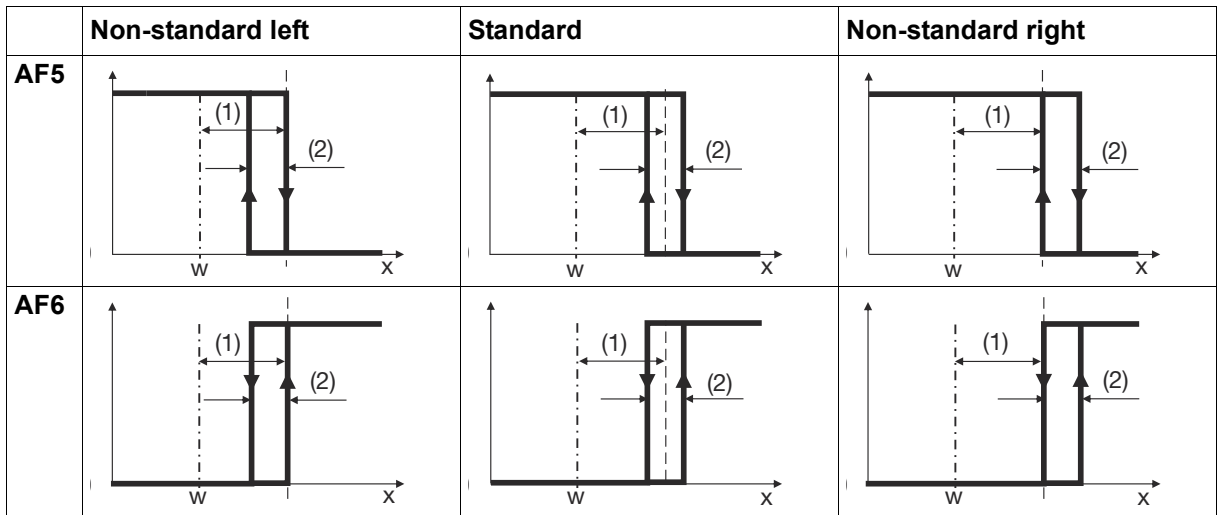

1 Output signal active
 0 Output signal not active
 x Actual value
 w Setpoint value
 (1) Limit value (setpoint value distance)
 (2) Hysteresis

Fixed limit value

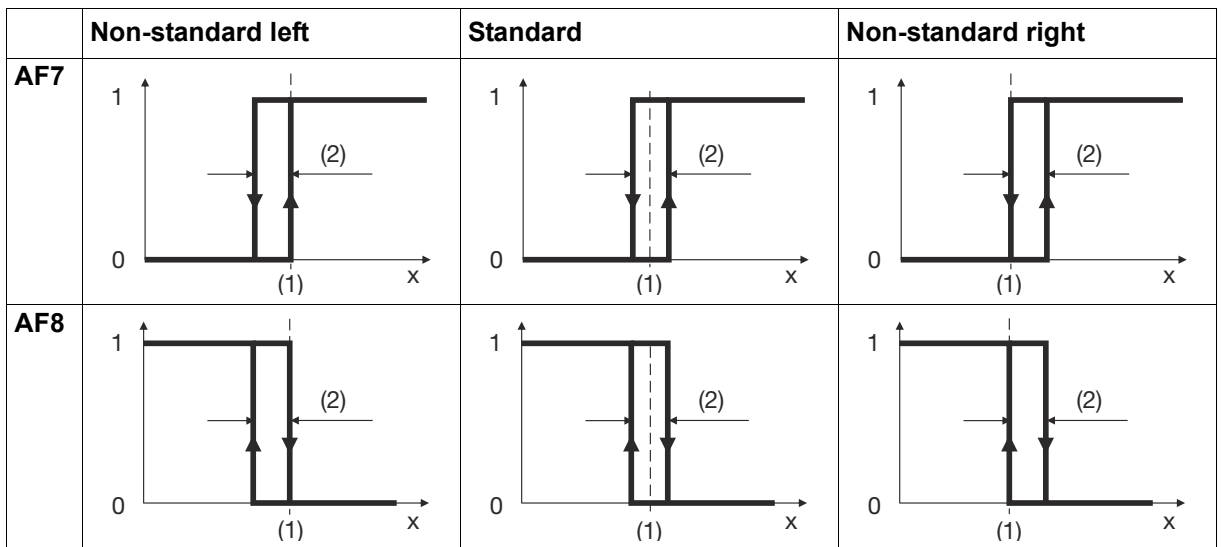

1 Output signal active
 0 Output signal not active
 x Actual value
 (1) Limit value
 (2) Hysteresis

12.9.2 Hysteresis

The designations "Non-standard left" and "Non-standard right" typically relate to alarm functions AF3/AF4 and AF7/AF8. The designation is not conclusive for alarm functions AF1/AF2 and AF5/AF6.

⇒ Chapter 12.9.1 "Function and hysteresis", page 102

12 Configuration

12.9.3 Start-up alarm suppression

Active start-up alarm suppression means:

- After power on, the output signal remains inactive, even if the actual value is in the alarm range.
- If the limit value or setpoint value is changed so that the actual value moves from outside of the alarm range to within the alarm range, the output signal remains inactive
- The limit value monitoring only starts to operate according to its alarm function again once the actual value has left the alarm range. This means that the output signal remains inactive until the actual value returns to the alarm range.

Example of active start-up alarm suppression

The following example shows monitoring of the actual value "x" with the alarm function AF4 (without hysteresis) for a specified limit value (1). The setpoint value is changed from w1 to w2.

Output state: The output signal is not active as the actual value is outside of the alarm range (gray area).

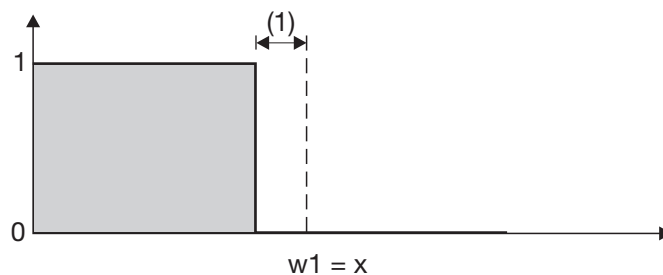

Change of setpoint value: The output signal remains inactive, although the actual value is now within the alarm range.

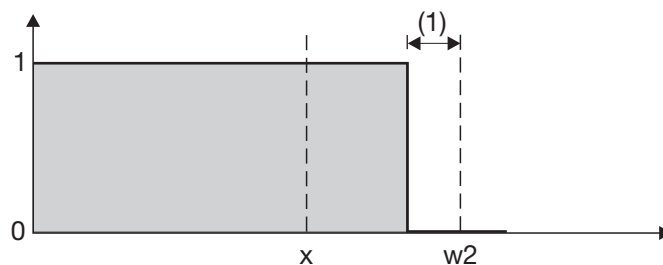

Set state: The actual value has left the alarm range and reached the new setpoint value. The output signal remains inactive until the actual value returns to the alarm range.

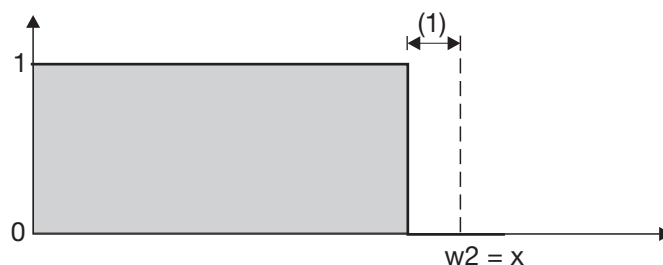

12.9.4 Acknowledging self-locking

For an alarm function, for example, one that is set to monitor an important process temperature, it may be necessary leave it permanently in this state rather than automatically resetting it.

If **INACTIVE STATUS** is set, this self-locking is only acknowledged if the actual value returns to the permitted area.

If **ACTIVE STATUS** is set, this self-locking can always be acknowledged.

Self-locking takes priority over the switch-off delay.

12.9.5 Alarm

In addition to evaluation of the limit value monitoring output signal, there is also the option to make an entry in the event list in the case of an alarm.

Setup dialog

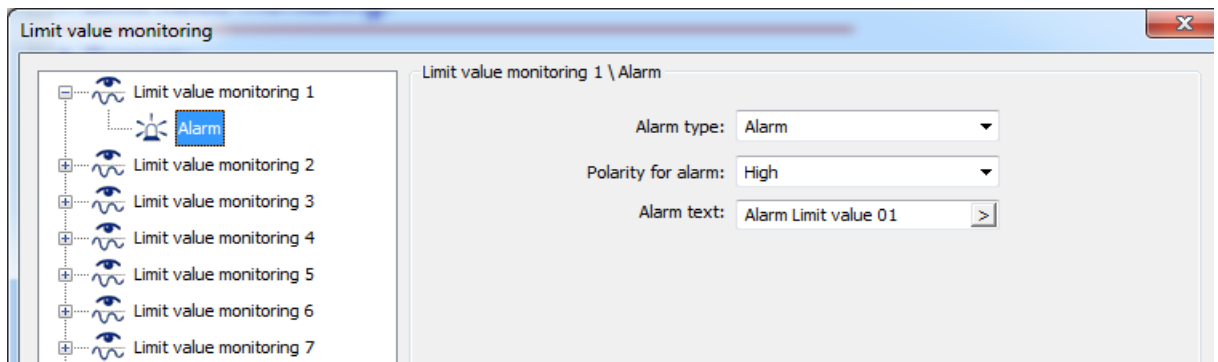

Parameter

Parameter	Selection/settings	Description
Alarm type	Off	Alert switched off.
	Alarm	A message will be entered in the alarm list depending on the signal level that has been set.
	Event	A message will be entered in the events list depending on the signal level that has been set.
Polarity for alarm	High Low	Limit value monitoring: High (logic "1") Limit value monitoring: Low (logic "0")
Alarm text 	Alarm limit value 01	20 characters of editable text which is entered into the alarm or event list.

Alarm text

Setup program: Selection of text from a list

Clicking on the ">" button opens a list with text numbers and the associated texts. The texts are editable.

12 Configuration

12.10 Screen

The screen selection and the appearance of those screens in the operating loop is set using this function.

12.10.1 General configuration

Setup dialog

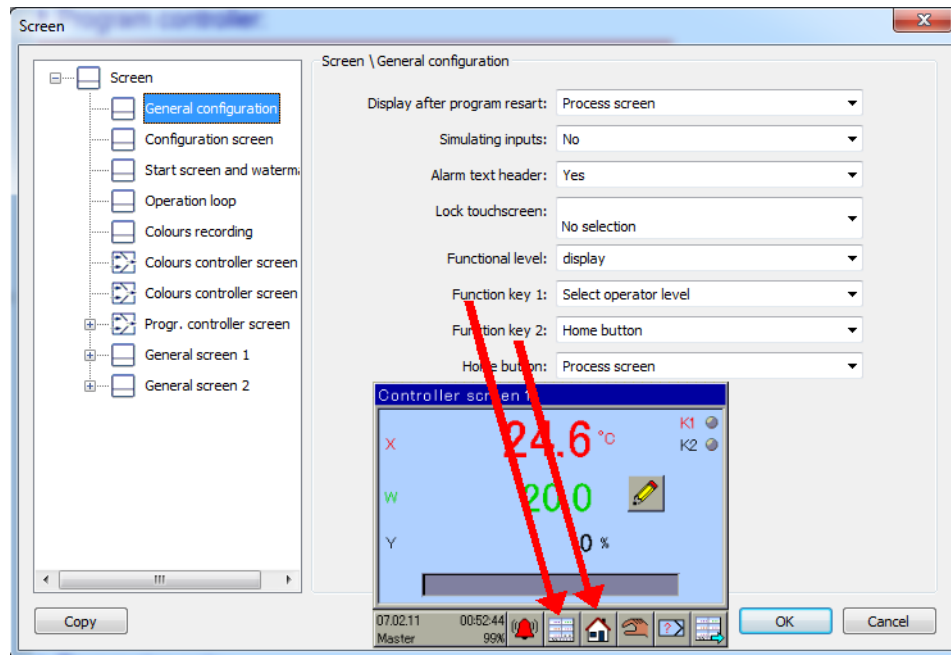

Parameter

Parameter	Selection/settings	Description
Display after restart	Controller screen 1	Any of the screens in the operating loop can be selected as the start screen.
Simulate inputs	No	Genuine recorded data is shown.
	Yes	Simulated data is displayed within the measuring range.
Alarm text for header	Yes	Alarms are inserted cyclically in the header.
	No	Alarms are not inserted.
Lock touchscreen	No selection	The screen can be locked to prevent unauthorized operation.
	Digital selector	
Functional level	Display	⇒ Chapter 10.1 "General information", page 55
	Fade out	
Function button 1	Selecting user level	A selection of functions appears here that can be started using the function buttons.
Function button 2	Home button	
Home button	Controller screen 1	Any of the screens in the operating loop can be selected.

12.10.2 Configuring the screen

The screen brightness and the screensaver can be set using this function.

Setup dialog

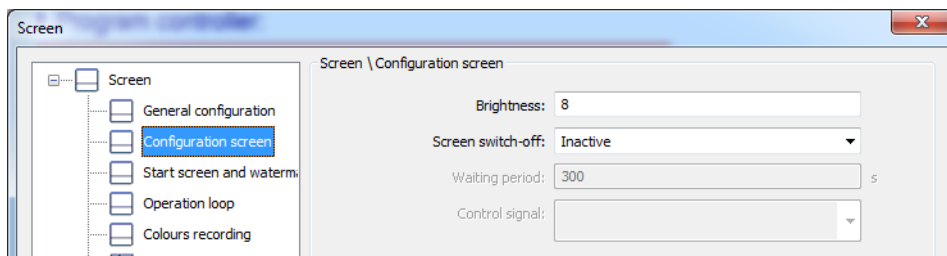

Parameter

Parameter	Selection/settings	Description
Brightness	0 to 8 to 10	Screen brightness
Screen switch-off	Switched off	Screen is always on
	Waiting period	Screen is switched off following a waiting period.
	Controller signal	Screen is switched off with a signal.
Waiting period	10 to 300 to 32767 s	If the screen is not touched, it will turn off after this period.
Controller signal	No selection	No switch-off
	Digital selector	This signal switches the screen off.

12.10.3 Start screen and watermark

Background screens and watermarks are set using this function.

Setup dialog

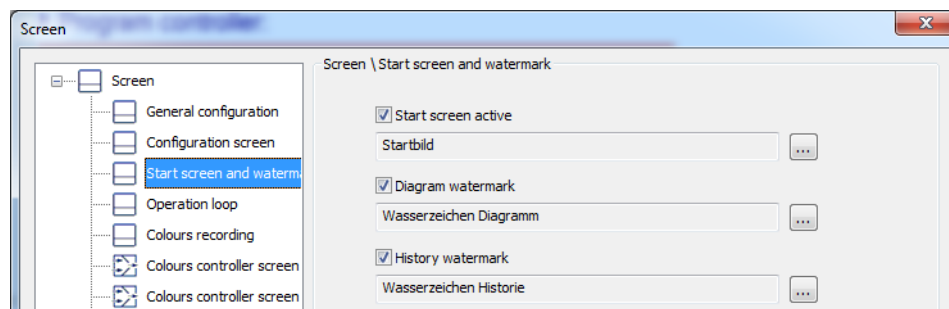

Parameter

Parameter	Selection/settings	Description
Start screen active	Default JUMO Sensors+Automation	Any screen shown with power ON (for example, your company logo).
Watermark in diagram	Default JUMO	Any screen shown as a watermark in the recorder image.
Watermark history		

12 Configuration

12.10.4 Operating loop

Screens are set to appear in the operating loop using this function.

Setup dialog

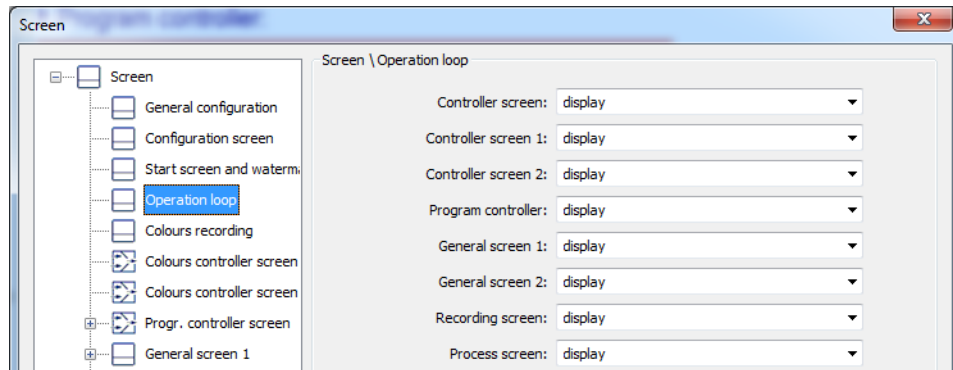

Parameter (only setup)

Parameter	Selection/settings	Description
Controller screen 1	Display/do not display	
Controller image 2	Display/do not display	
Controller over-view	Display/do not display	
Program controller	Display/do not display	
General screen 1	Display/do not display	
General screen 2	Display/do not display	
Process screen	Display/do not display	

12.10.5 Recording colors

The colors for the channels and alarms displayed can be set using this function.

Setup dialog

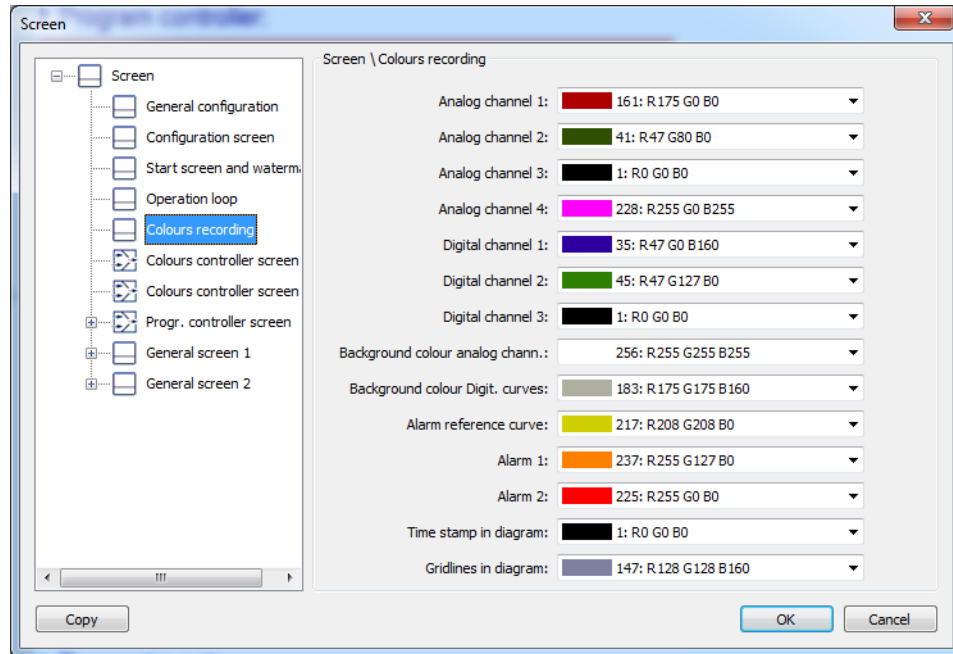

Parameter

Parameter	Selection/settings	Description
Analog channel 1 to 4		The color for the recording data can be selected in the RGB color selector.
Digital channel 1 to 3		
Background color for analog channels		
Background color for digital channels		
Alarm for reference channel		
Alarm 1		
Alarm 2		
Time stamp in diagram		
Grid lines in diagram		

12 Configuration

12.10.6 Color for controller screens 1, 2

The colors for controller image 1 and 2 can be set using this function.

Setup dialog

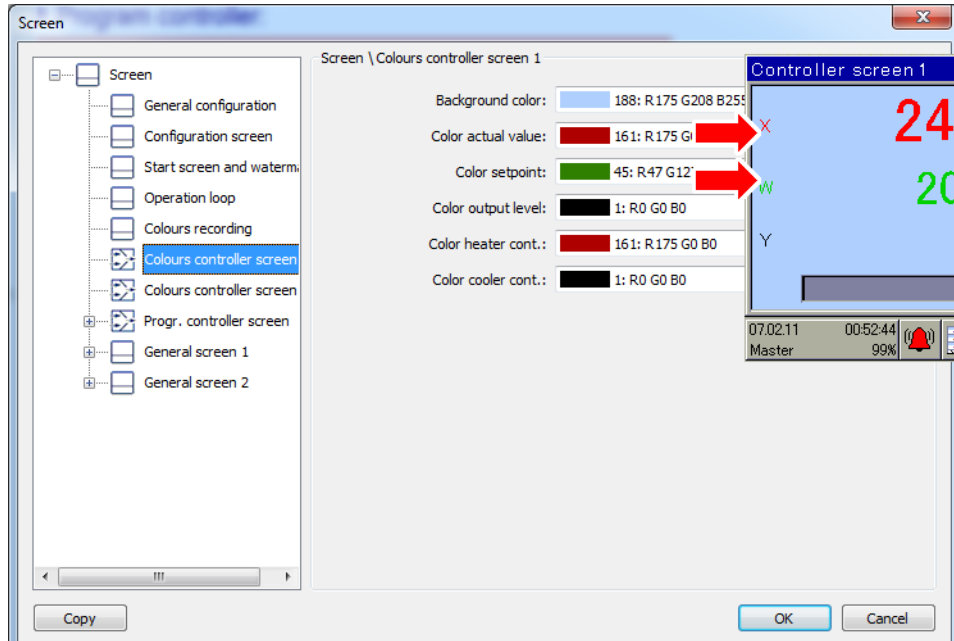

Parameter

Parameter	Selection/settings	Description
Background color		RGB color selector
Color for actual value		
Color for setpoint value		
Color for output level		
Color for heating contact		
Color for cooling contact		

12.10.7 Program controller screen

Setup dialog

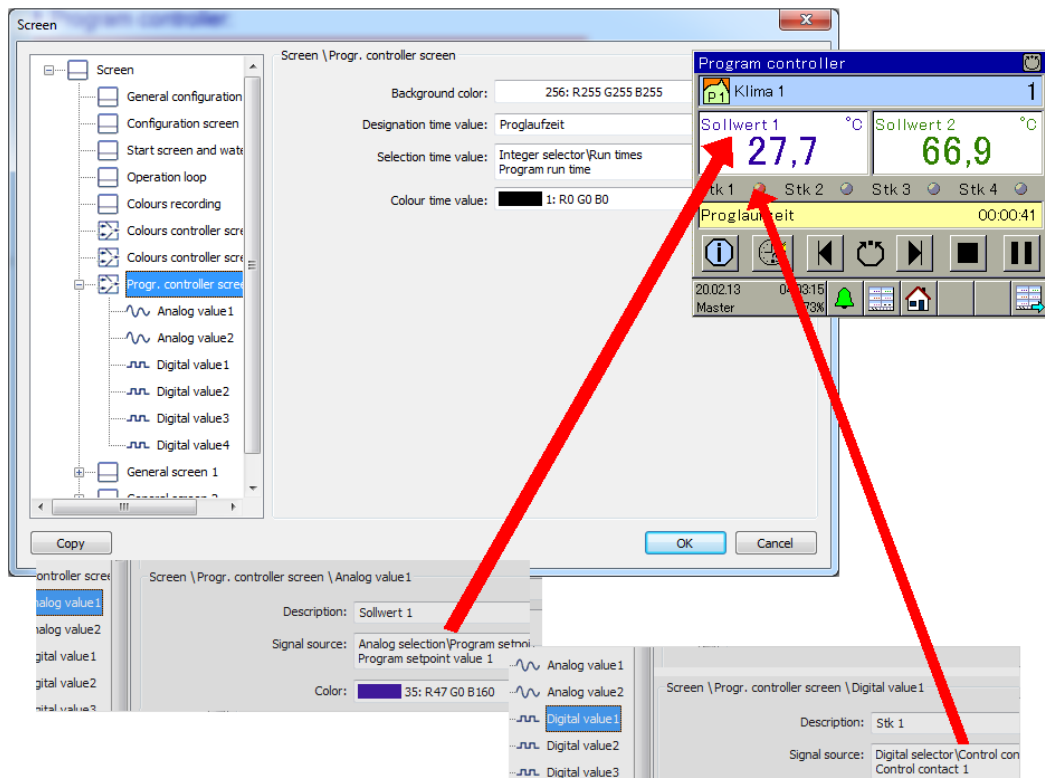

Parameter

Parameter	Selection/settings	Description
Background color		RGB color selector
Designation of time value		Program runtime
Signal source	No selection Analog selector (integer)	
Color for time value	R0 G0 B0	RGB color selector

Parameter for analog value 1 to 4, digital value 1 to 4

Parameter	Selection/settings	Description
Designation	Setpoint 1	Text for analog value 1 to 3
Signal source	No selection Analog selector	
Color	RGB color selector	Color for analog values and text
Designation	Stk 1	Text for digital values 1 to 4
Signal source	No selection Digital selector	

12 Configuration

12.10.8 General screens 1, 2

Setup dialog

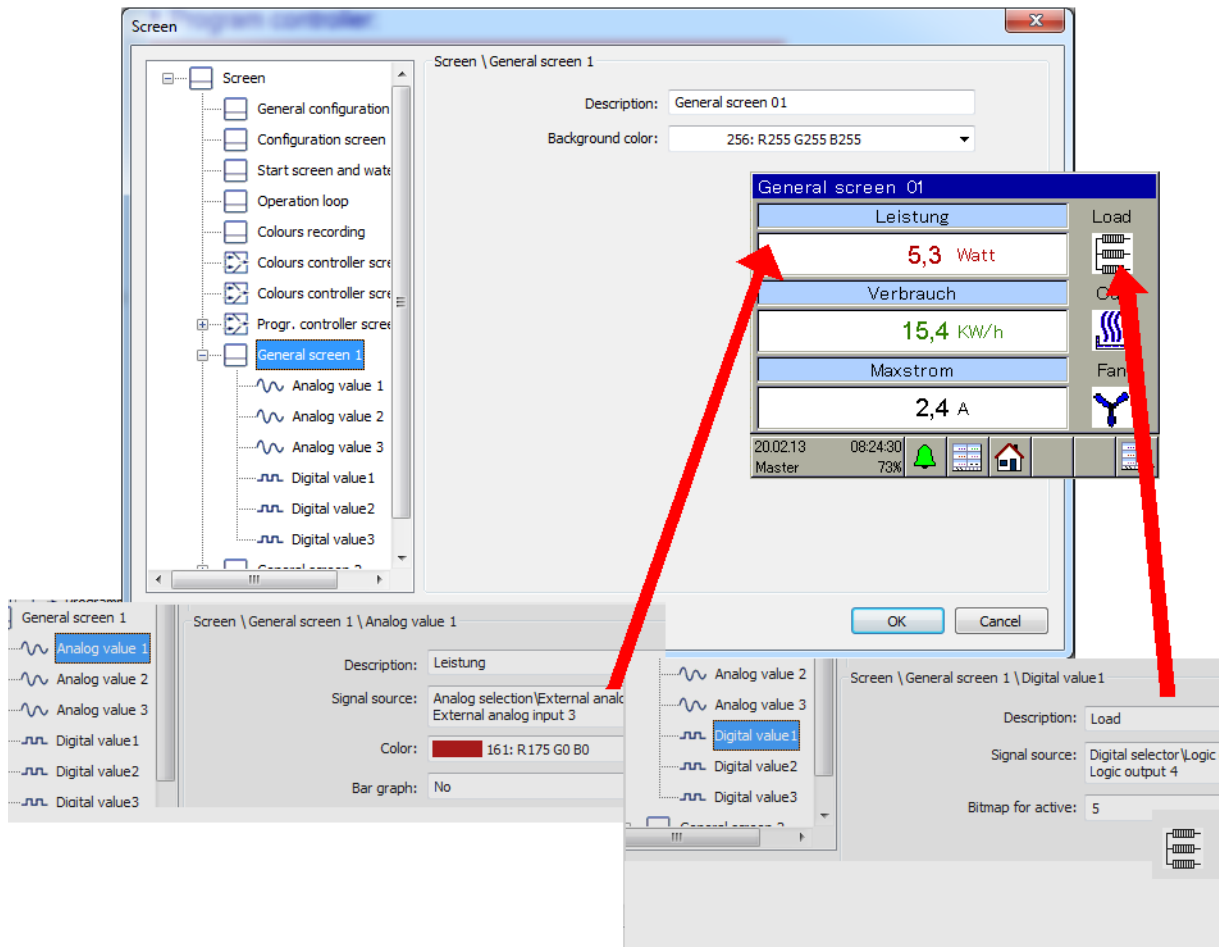

Parameter

Parameter	Selection/settings	Description
General screen	General screen 01	Text for general screen 1
Background color	(white)	RGB color selector
Designation	Analog value 1 to 3	Text for analog value 1 to 3 (in light-blue box)
Signal source	No selection Analog selector	Any analog value can be displayed here
Color	RGB color selector	Color for analog values and text
Bar graph	Yes	Bar graph
	No	No bar graph
Color for bar graph	RGB color selector	Color for analog values and text
Designation	Digital value 1 to 3	Text for digital value 1 to 3 (in gray area)
Signal source	No selection Digital selector	Any digital value can be displayed here

12.11 Recording



NOTE!

The recording is switched off by default and a maximum of four analog signals and a maximum of three digital signals are displayed in the form of a recording screen. Release is required for the recorded data to be saved or read out and processed.

⇒ Chapter 15.6 "Enabling of extra codes", page 163

The appearance of the recording image can be set here.

The watermark can be adjusted here

⇒ Chapter 12.10.3 "Start screen and watermark", page 107

12.11.1 Parameter

Setup dialog

In this example, four analog signals and three digital signals are recorded per second.

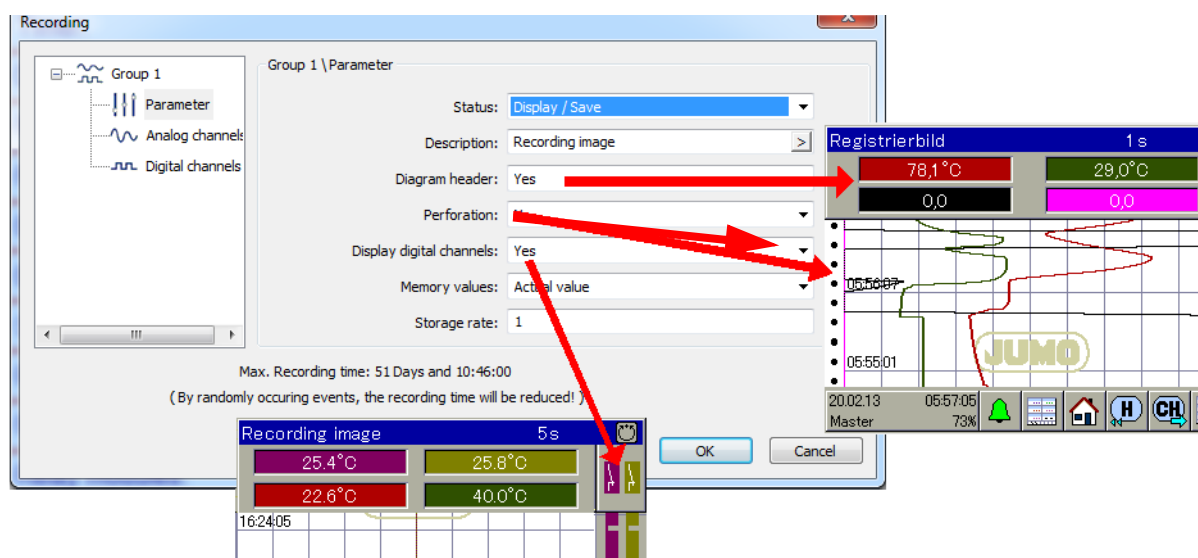

Parameter

Parameter	Selection/settings	Description
Status	Switched off	The temporal variation of the analog and digital signals is first displayed on the screen and then saved.
	Display and save	
Designation	Recording image	Text for recording image
Diagram header	Yes	Numeric representations of the analog signals ⇒ Chapter 12.10.5 "Recording colors", page 109
	No	No diagram header visible
Perforation	Yes	Only visible if digital channels are switched off.
	No	No perforation visible
Display digital channels	Yes	Digital signal levels are highlighted in color.
	No	
Memory values	Mean value	The mean value is calculated using the set memory cycle and saved.

12 Configuration

Parameter	Selection/settings	Description
	Current value	The value is saved at the scanning instance.
	Minimum value	The minimum is determined and saved using the set memory cycle.
	Maximum value	The maximum is determined and saved using the set memory cycle.
Memory cycle	1 to 5 to 3600 s	A value is recorded every 5 seconds.

Updating/backing up recording data

When the memory data recorder is full, the recorded data can be saved on the PC using data archiving software or exported onto a mass storage device. The USB host socket is used for this purpose.

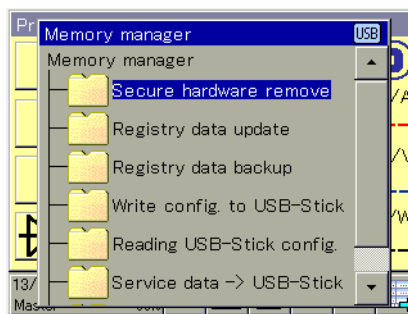

Function	Meaning
Safely remove hardware	To prevent hardware damage or loss of data, it is necessary to select this menu item before removing an inserted USB stick. Please follow the instructions on the device's display.
Recorded data update	Measurement data that have not yet been retrieved are stored on the stick together with their configuration data. The measurement data are stored in DAT files and the configuration data in SET files. This data can be opened and evaluated with the aid of the JUMO PCA3000 evaluation software. Data that has been read out is marked internally as retrieved and the available memory display is reset to 100 %.
Recorded data backup	All measurement data in the ring buffer (including data already retrieved) are transmitted to the memory stick together with their configuration data. The measurement data are stored in DAT files and the configuration data in SET files. These files can be opened and evaluated with the aid of the JUMO PCA3000 evaluation software. In contrast to the recorder update, there is no internal marking of the recorder data and no reset of the available memory display.

Table 1:

12.11.2 Analog channels

Setup dialog

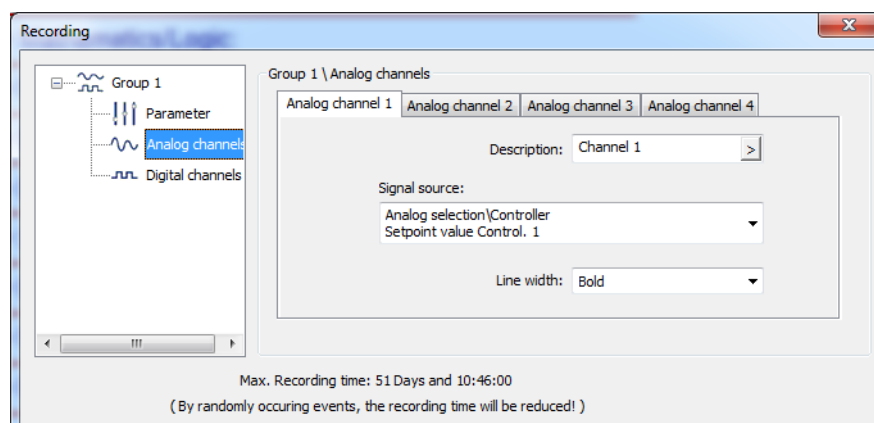

Parameter

Parameter	Selection/settings	Description
Analog signal 1 to 4		
Designation	Channel 1	
Signal source	No selection Analog selector	Any analog value can be recorded here
Line width	Fine	
	Bold	

12.11.3 Digital channels

Setup dialog

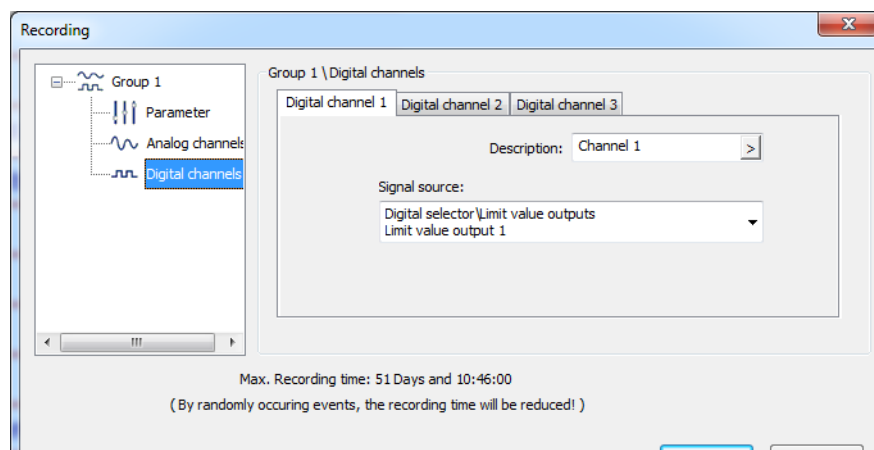

Parameter

Parameter	Selection/settings	Description
Digital signal 1 to 3		
Designation	Channel 1	
Signal source	No selection Digital selector	Any digital value can be displayed here

12 Configuration

12.12 Program controller

You can choose here between the program controller and the fixed-setpoint controller. With the fixed-setpoint controller, all program functions are deactivated and the setpoint values are switched, as described in Chapter 11.4 "Setpoint values", page 62.

Setup dialog for fixed-setpoint controller

With the fixed-setpoint controller, all additional program functions are grayed out and therefore inactive.

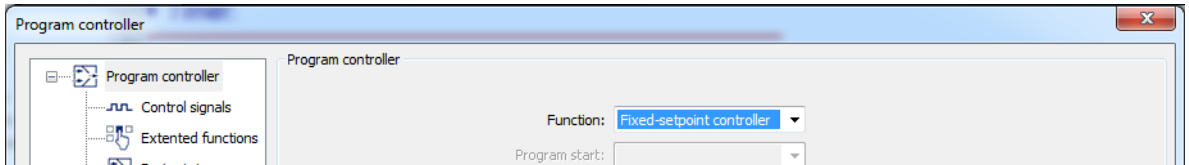

Setup dialog for program controller

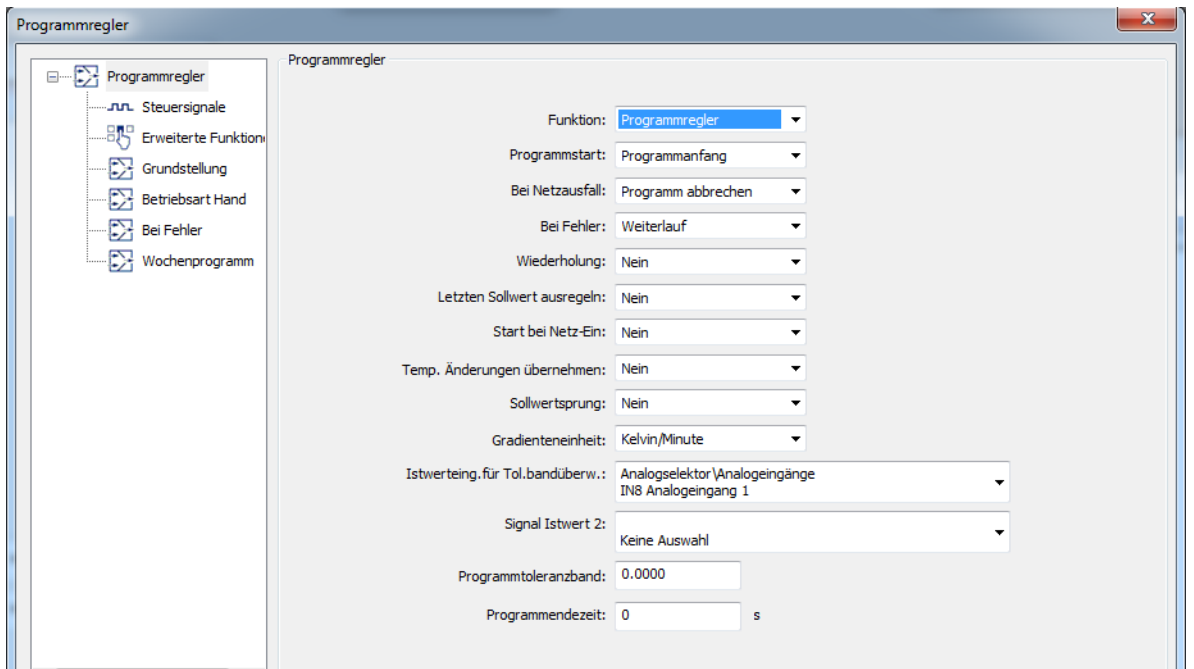

Parameter

Parameter	Selection/settings	Description
Function	Fixed-setpoint controller Program controller	All additional parameters are grayed out for this setting.
Program start	From program start Actual value Time	Program is ... at start ... at current actual value started at this time.
In the event of power failure	Abort	The program is aborted following a power failure.
	Continuous operation	The program continues to run from the point of disruption after the power failure.

12 Configuration

Parameter	Selection/settings	Description
	Start at actual value	The program continues to run from the point of disruption after power failure.
In the event of an error	Continuous operation	Program continues to run.
	Program stop	The time base for the program generator is halted.
Repeat	No	No program repeat
	Yes	-
Regulate last setpoint value	No	-
	Yes	Regulates the power return on the last setpoint value.
Start with power on	No	No automatic program start after power on.
	Yes	Automatic program start after power on.
Adopt temp. changes	No	Temporary changes not adopted.
	Yes	Adopt temporary changes
Setpoint step	No	
	Yes	
Gradient unit	Kelvin/minute Kelvin/hour Kelvin/day	
Actual value input for tolerance band monitoring	IN8 analog input 1 Analog selector	This value is monitored by the tolerance band. ⇒ Chapter 12.6.7 "Ramp function", page 95
Signal for actual value 2	IN8 analog input 1 Analog selector	
Program tolerance band	0.0000 to 1.0000 to 9999.0	Value of the tolerance band
Program end time	0.0000 to 9999.0	

12 Configuration

12.12.1 Controller signals

Setup dialog

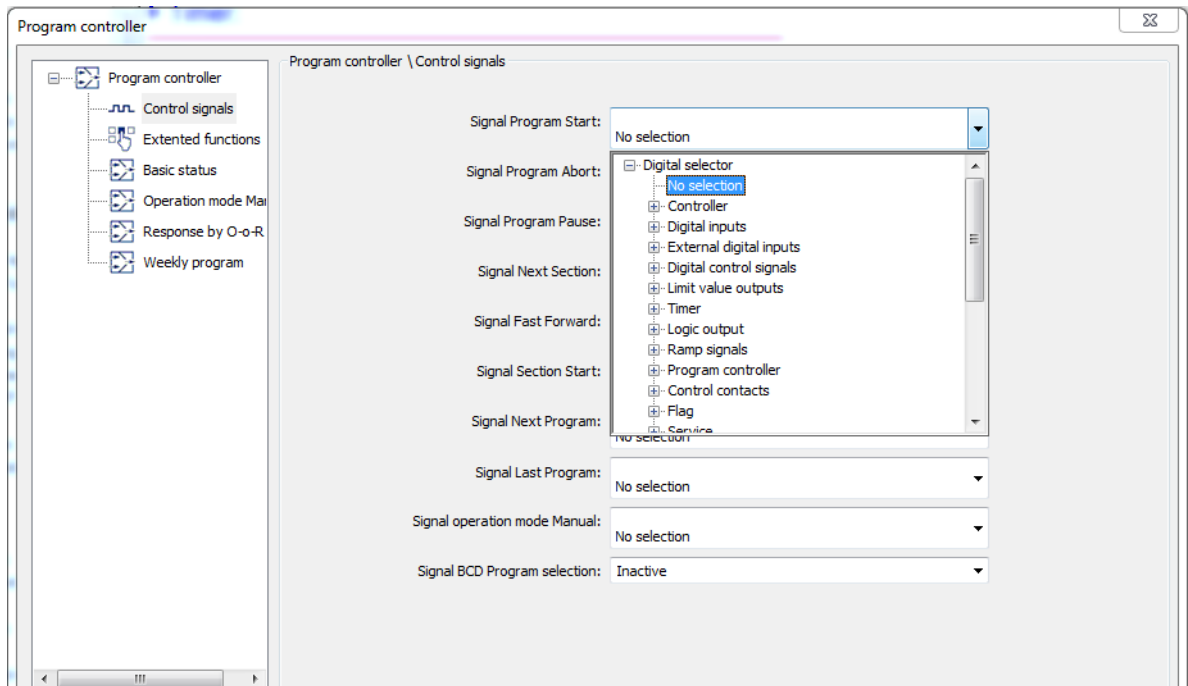

Parameter

Parameter	Selection/settings	Description
Signal Program Start	Digital selector No selection	This signal starts a program.
Signal Program Abort	Digital selector No selection	This signal aborts a program.
Signal Program Stop	Digital selector No selection	This signal stops a program.
Signal Next Section	Digital selector No selection	This signal switches to the next program section.
Signal Fast Forward	Digital selector No selection	This signal fast forwards through the programs. The longer the signal appears for, the faster the process.
Signal Section Start	Digital selector No selection	Switches back to section start.
Signal Next Program	Digital selector No selection	Start next program
Signal Last Program	Digital selector No selection	Start last program
Signal Manual Operation Mode	Digital selector No selection	Start manual mode
Signal BCD Program Selection	Switched off	Program selection using digital controller signals

Parameter	Selection/settings	Description
	Digital controller signal 1 to 8	

12.12.2 Extended functions

Setup dialog

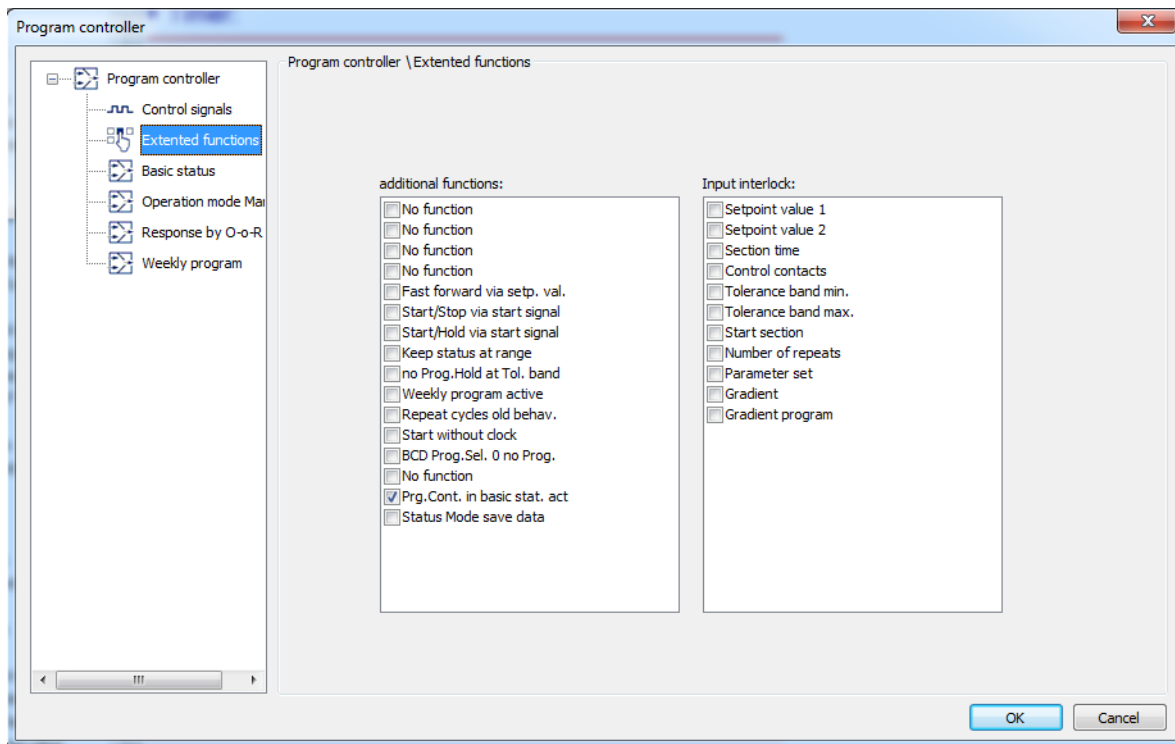

Parameter

Parameter	Selection/settings	Description
Add. prog. functions	Not selected (empty)	-
	() No function () Fast forward etc.	Reserved functions for service
Input lock	Not selected (empty)	-
	() Setpoint value 1 () Setpoint value 2 () Section time () Control contacts () Tolerance band min. () Tolerance band max. () Start section () Number of repetitions () Parameter block	The checked program controller functions are locked.

12 Configuration

12.12.3 Basic status

This is where settings are adjusted for what should be active in the basic status of the program controller, that is, if no program is active in automatic mode.

Setup dialog

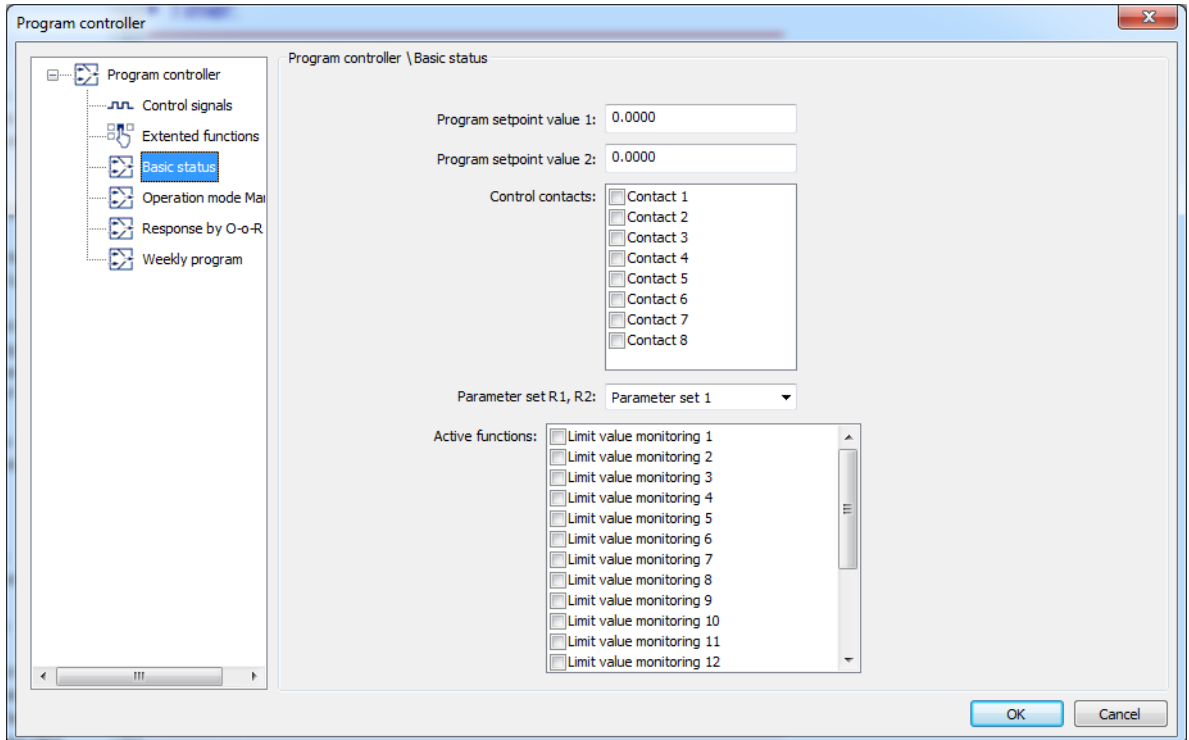

Parameter

Parameter	Selection/settings	Description
Program setpoint value 1	0.00 to 99999	The value entered here is the active basic status.
Program setpoint value 2	0.00 to 99999	
Control contacts	Not selected (empty) () Contact 1 to 8	Checked control contacts are active in the basic status.
Parameter block R1/R2	Parameter block 1 to 4	The parameter block set here is active for both controllers in the basic status
Active functions	Not selected (empty) () Limit value monitoring 1 to 12 () Controller 1, 2	The checked limit value monitoring is active in the basic status. The checked controller is active in the basic status

12.12.4 Manual operation mode

You can set what is active in manual operation mode here.

Setup dialog

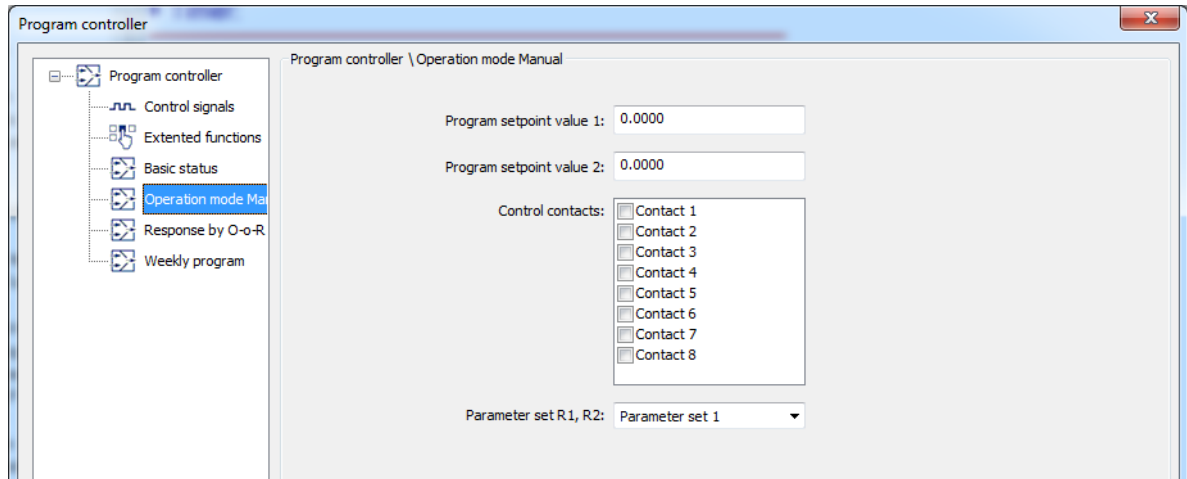

Parameter

Parameter	Selection/settings	Description
Program setpoint value 1	0.00 to 99999	The value entered here is active in manual operation mode.
Program setpoint value 2	0.00 to 99999	
Control contacts	Not selected (empty) () Contact 1 to 8	Checked control contacts are active in manual operation mode.
Parameter block R1/R2	Parameter block 1 to 4	The parameter block set here is active for both controllers in manual operation mode

12 Configuration

12.12.5 Behavior for out of range parameters

Here you can set which parameters should be active in the program controller in the event of a deviation above or below the measuring range.

Setup dialog

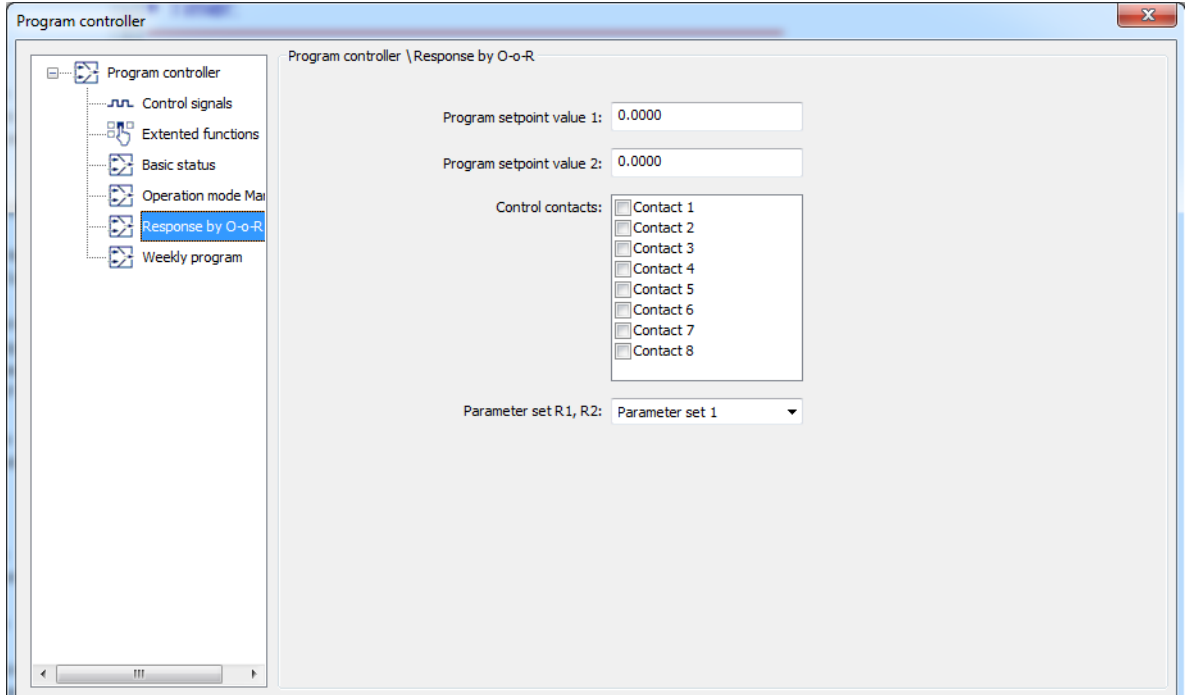

Parameter

Parameter	Selection/settings	Description
Program setpoint value 1	0.00 to 99999	The value entered here is active for out of range parameters.
Program setpoint value 2	0.00 to 99999	
Control contacts	Not selected (empty) () Contact 1 to 8	Checked control contacts are active when out of range.
Parameter block R1/R2	Parameter block 1 to 4	The parameter block set here is active for both controllers when out of range

12.12.6 Weekly program

Ten different weekly programs can be defined here.

Setup dialog

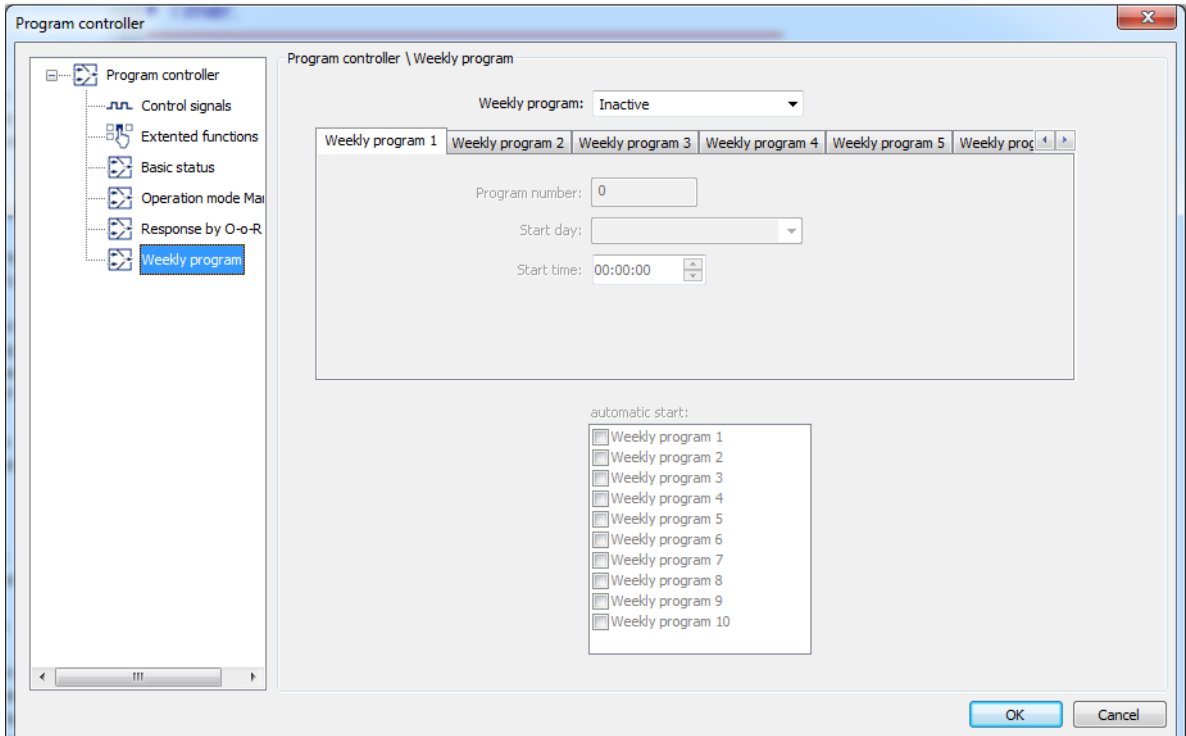

Parameter

Parameter	Selection/settings	Description
Automatic start	Not selected (empty) () Weekly program 1 to 10	Checked weekly programs start automatically
Weekly program 1	Program number: 0 Program number: 1 Start day: Sunday Start time: 1	Inactive Number of program to be started Program starts on this day Program starts at this time
Weekly program 2 to 10	Program number Start day Start time	Number of program to be started Program starts on this day Program starts at this time

12 Configuration

12.13 Timer or time switch

Two functions are available that can be used as a timer or time switch. The settings can be copied to another timer using the **COPY** button.

Setup dialog timer

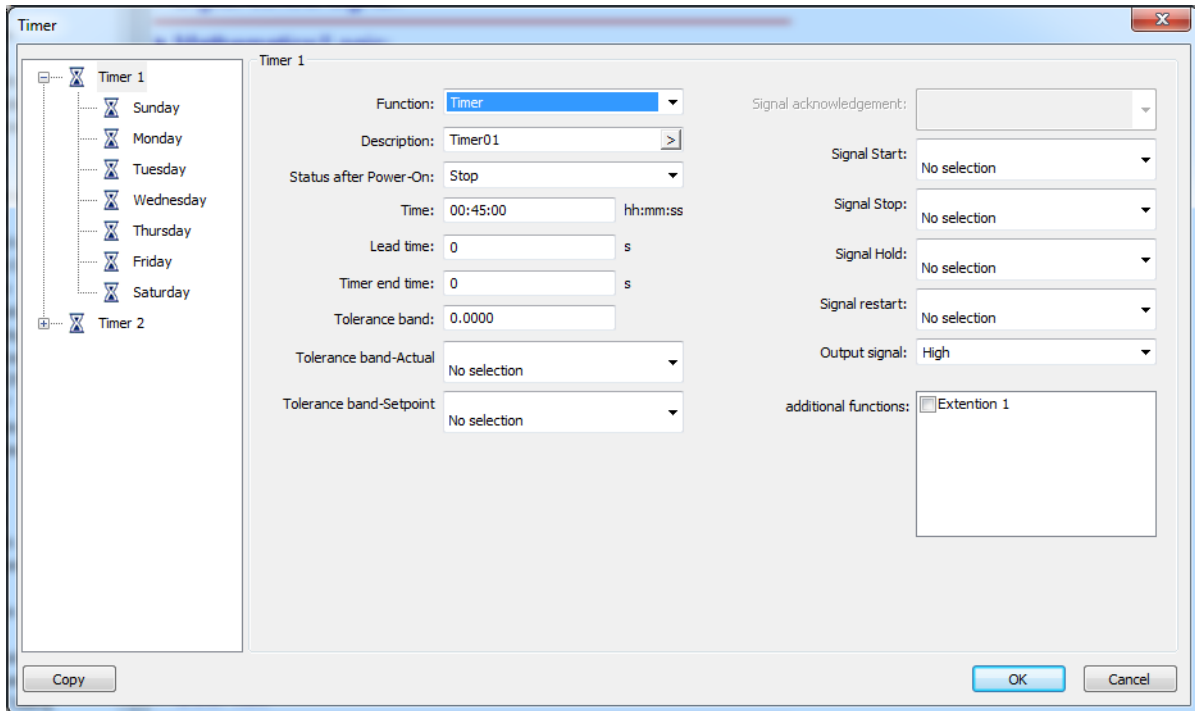

Parameter

Parameter	Selection/settings	Description
Function	Inactive	-
	Timer	Timer function active, time switch grayed out
Designation	Timer 01	(15 characters) of editable text
Behavior after power on	Stop	The timer is stopped after power failure.
Lead time	0 to 9999	Lead time, until the timer is started
Timer time	00:00:00 to 99:59:59	The timer works for this time period
Timer end time	0 to 9999	Time until the timer is stopped
Tolerance band	0.0000 to 99999	If the distance between the tolerance band setpoint and actual values still lies within the tolerance band, the timer output signal is low (logic "0").
Tolerance band actual value	Analog selector	These values are compared with one another: If setpoint and actual values lie far apart from one another and exceed the tolerance band, the timer stops and the timer output signal changes to high (logic "1").
	No function	
Tolerance band setpoint value	Analog selector	
	No function	
Acknowledgement signal		A timer alarm is acknowledged with this signal.

12 Configuration

Parameter	Selection/settings	Description
Start signal	Digital selector No function	The timer is started with this signal
Stop signal	Digital selector No function	The timer is stopped with this signal
Signal hold	Digital selector No function	The timer is halted with this signal.
Restart signal	Digital selector No function	
Output signal	High	The signal level is set here for the active timer.
	Low	This signal is available in the digital selector for further use.
Additional timer function	Not selected (empty)	Reserved functions for service
	(\) Extension 1	

Setup dialog for time switch

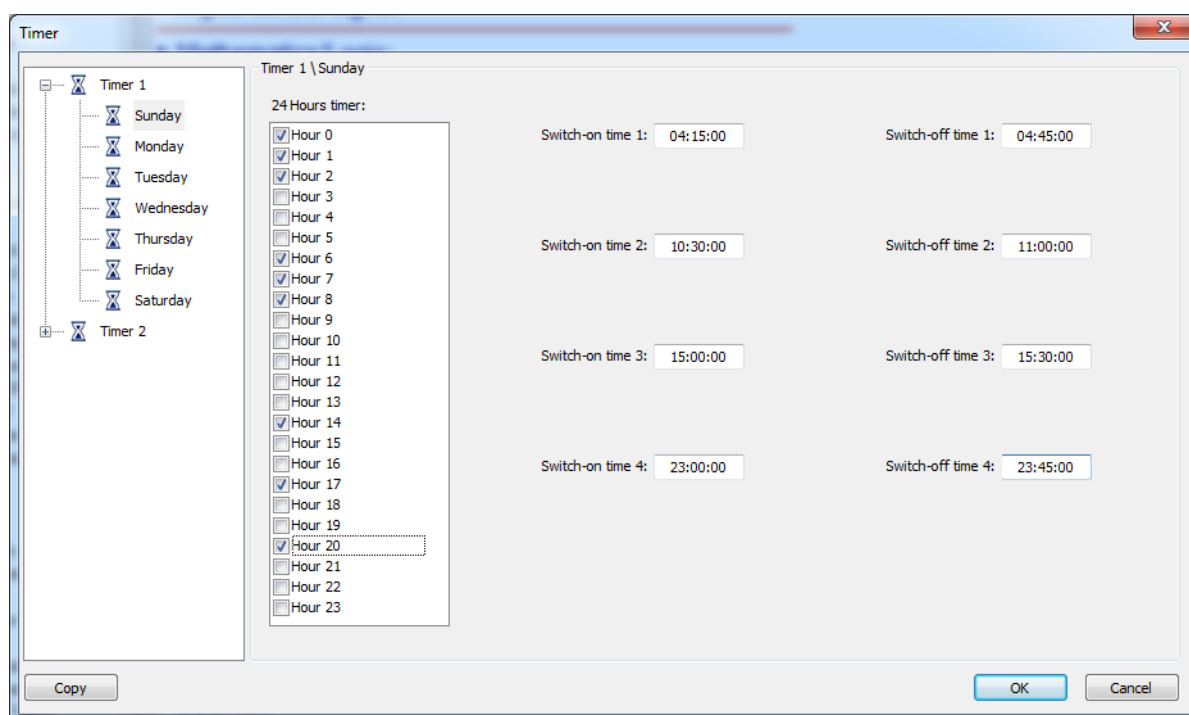

Parameter

Parameter	Selection/settings	Description
Function	Inactive	-
	Control timer	Timer function active, timer function grayed out
Sunday	Hours 0 to 24 (\)	The period of time for which the time switch should be active on this day can be selected in hour units here by checking the relevant box ("High": logic 1).
	Switch-on time 1 to 4	Four additional switch times can be set here, for example if the switch-on time period is less than a full hour.
	Break time 1 to 4	

12 Configuration

Parameter	Selection/settings	Description
Monday to Saturday	Hours 0 to 24 ()	Same settings possible as for Sunday
	Switch-on time 1 to 4	
	Break time 1 to 4	

12.14 Digital controller signals

A maximum of eight unrelated links with up to four signals each (digital selector) can be configured.

Use the **COPY** button to transfer the selected link to another link and to then make changes there as desired.

The result of a link is available in the digital selector.

Setup dialog

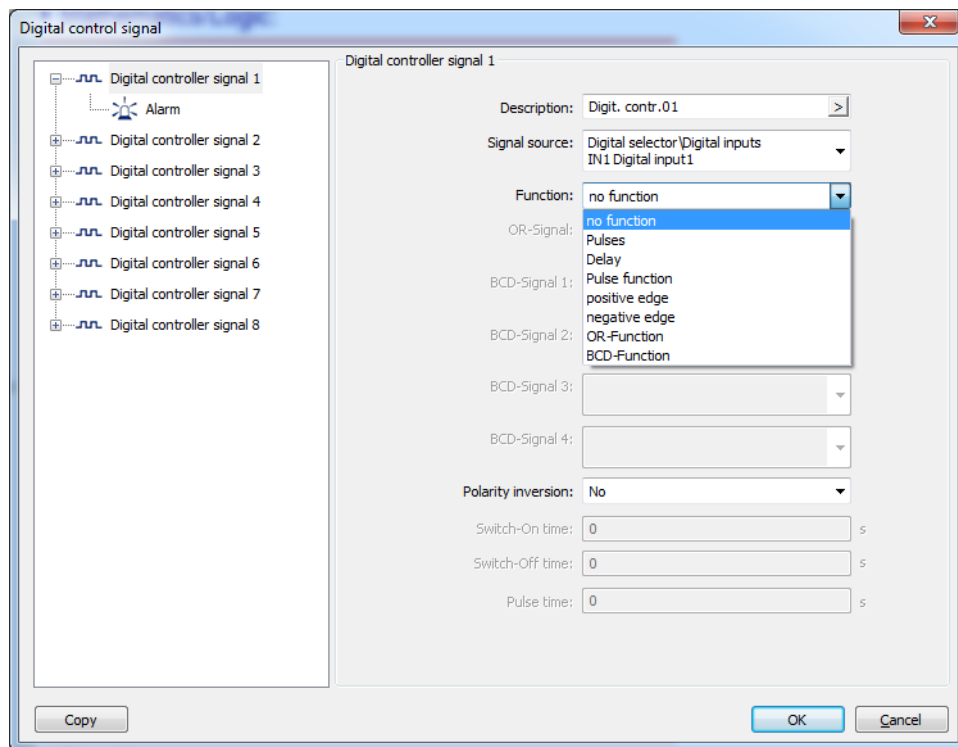

Parameter

Parameter	Selection/settings	Description
Designation	Digital controller 01	(15 characters) of editable text
Signal source	No selection Digital selector	Any digital value that should be linked with a function
Function	No function Impulse Delay Pulse function Positive slope Negative slope	-

12 Configuration

Parameter	Selection/settings	Description
	"Or" function BCD function	
"OR" signal	No selection Digital selector	Any digital value that should be linked with an OR signal source at top
BCD signal 1	No selection Digital selector	1st BCD digital value
BCD signal 2	No selection Digital selector	2nd BCD digital value
BCD signal 3	No selection Digital selector	3 BCD digital value
BCD signal 4	No selection Digital selector	4th BCD digital value
Inversion	No Yes	-
Switch-on time	0	For example, if the signal set under the signal source is delayed
Break time	0	
Pulse time	0	For example, if the signal set under the signal source has a pulse function

Function

The following screen shows an OR function for digital inputs 1 and 2, which is issued from digital output OUT2

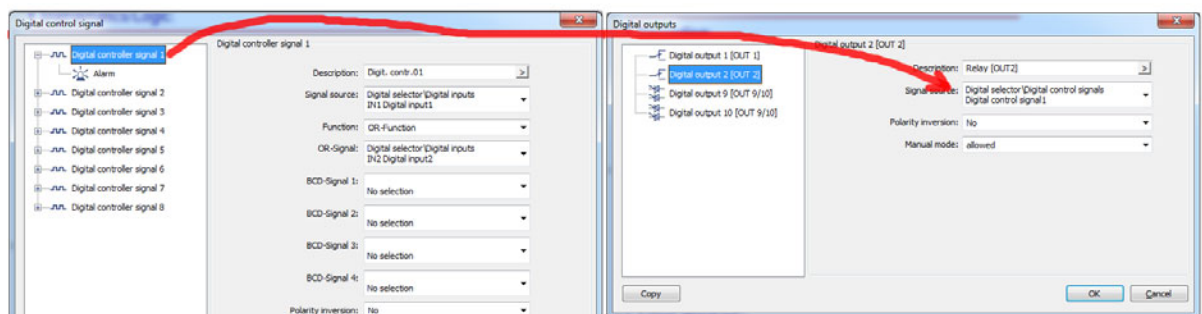

BCD signal

With the BCD function (Binary Coded Decimal), four digital signals (four-bit) are processed for one digital controller signal, for example, one that can switch between 16 different programs.

12 Configuration

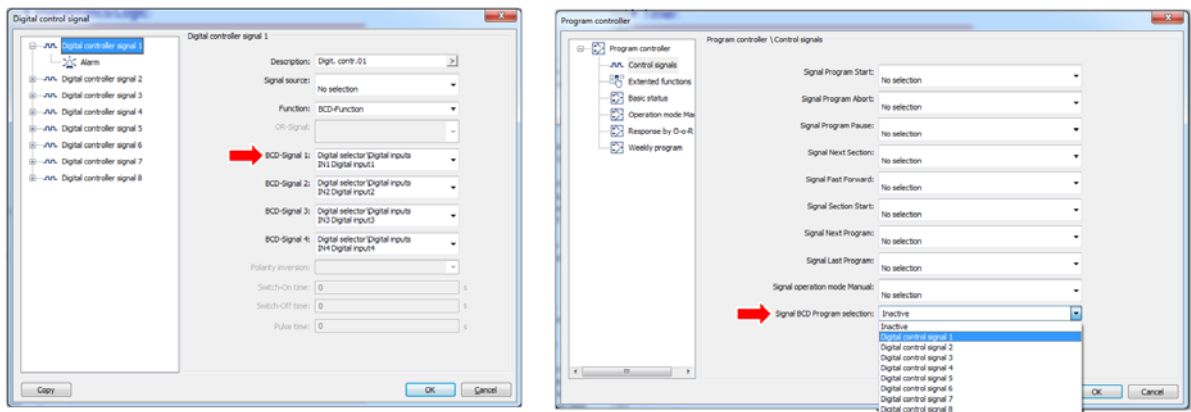

12.14.1 Alarms

Setup dialog

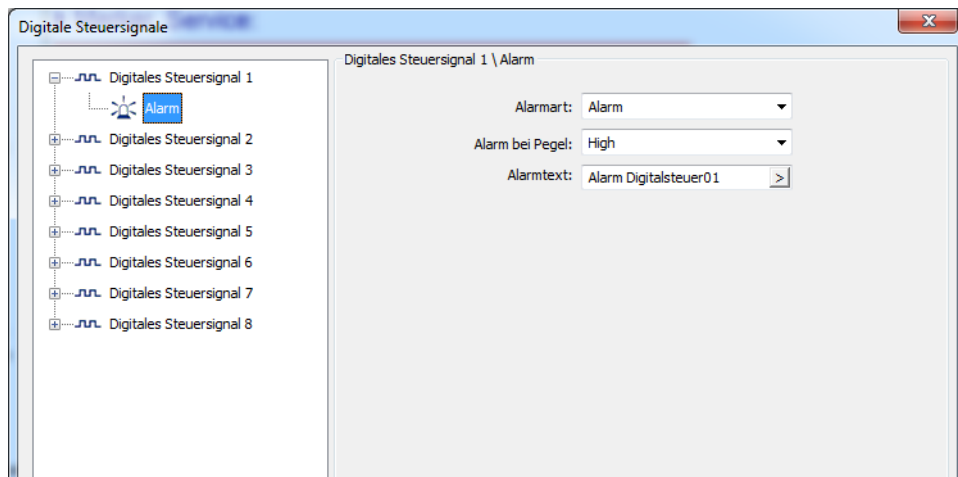

Parameter

Parameter	Selection/settings	Description
Alarm type	Off	Alert switched off.
	Alarm	A message will be entered in the alarm list depending on the signal level that has been set.
	Event	A message will be entered in the events list depending on the signal level that has been set.
Polarity for alarm (only setup)	Signal level that triggers a an alarm or event High Low	Digital controller signal: High (logic "1") Digital controller signal: Low (logic "0")
Alarm text (only setup) 	Alarm digital controller 01	20 characters of editable text which is entered into the alarm or event list.

Polarity for alarm

An alarm is only displayed for as long as the digital controller signal High (logic "1") is shown. If the signal level Low (logic "0"), the alarm entry disappears automatically.

Alarm text

The setup program is required to view and edit the texts.

12 Configuration

12.15 Mathematics/logic

Limited functionality only is possible on the device.

Programming, for example, of formulas, can be done using the setup program:

Eight functions are available. The optional mathematics/logic function supports four formulae, which can be used freely either for mathematical calculations (analog values) or for logical links (binary values). Fixed formulae for calculating the differential, ratio, and relative humidity are also provided. In this case, two analog values (variable A and B), for example, the measured values of analog input 1 and 2 are linked to each other. The dry-bulb temperature and the wet-bulb temperature are required for calculating the relative humidity and should be determined with a psychrometric humidity sensor.

The results are available in the analog selector or digital selector. If the function is not active, the mathematical value = 3.0E+37 and the logic value = 0 (FALSE). The settings can be copied to another math/logic function using the **COPY** button.

Setup dialog

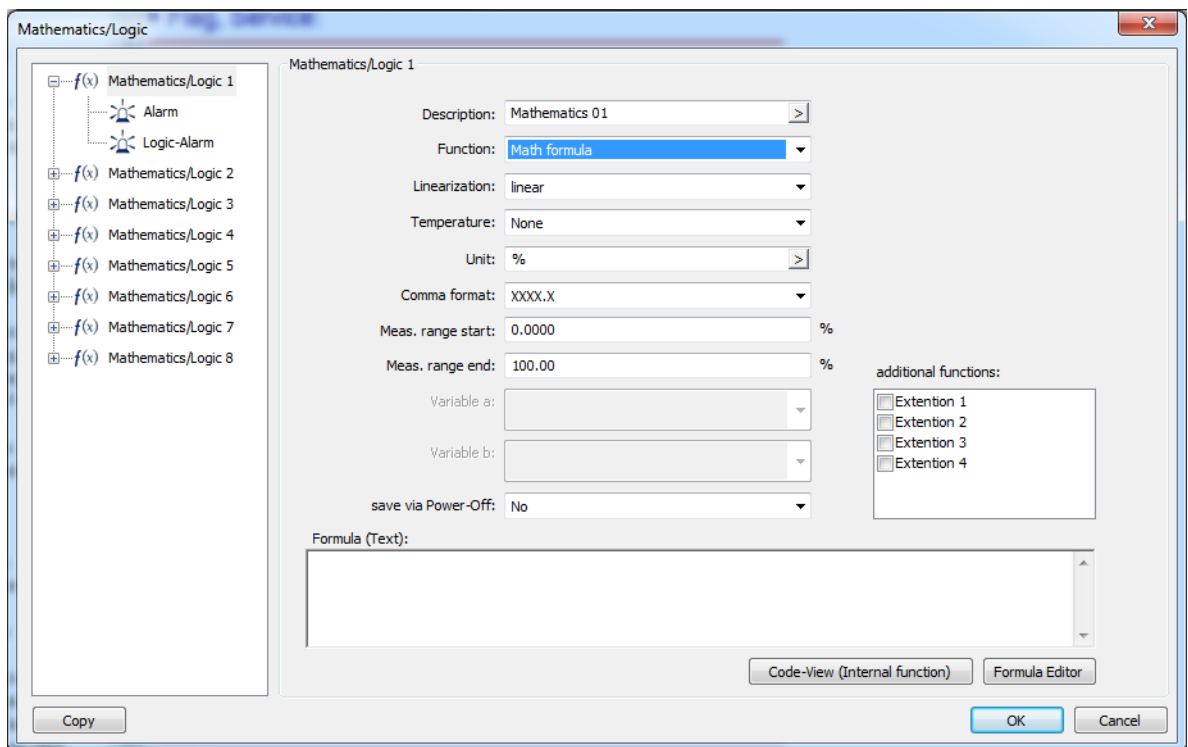

Parameter

Parameter	Selection/settings	Description
Designation	Math configuration 1 to 8 (inactive)	Name of the mathematical function available as a variable in the analog selector for further processing.
Function	Inactive Differential Ratio	Differential controller (a-b) Ratio controller (a/b)

Parameter	Selection/settings	Description
	Humidity Math formula Logic formula	Humidity controller (a;b) Mathematical linking (a+b) x 2 Logic linking (a AND b)
Linearization		The mathematical calculation can be linked with a (customer-specific) linearization table.
Secure using power off		
Measuring range start	0	
Measuring range end	100.00	
Variable a		
Variable b		
Unit	%	
Decimal place		
Temperature		
Additional math functions		Reserved functions for service
Formula (text)		

Function

The math and logic functions are available if the "Math/logic" option in the setup program has been activated.

Math formula, logic formula

Use the "Formula Editor" button to open an editor that can be used to create formulae by selecting variables and operators. Formulae can be entered freely according to standard mathematical rules. Any number of spaces may be used within the formula symbol string. Spaces are not admissible in function designations, names of variables, or constants.

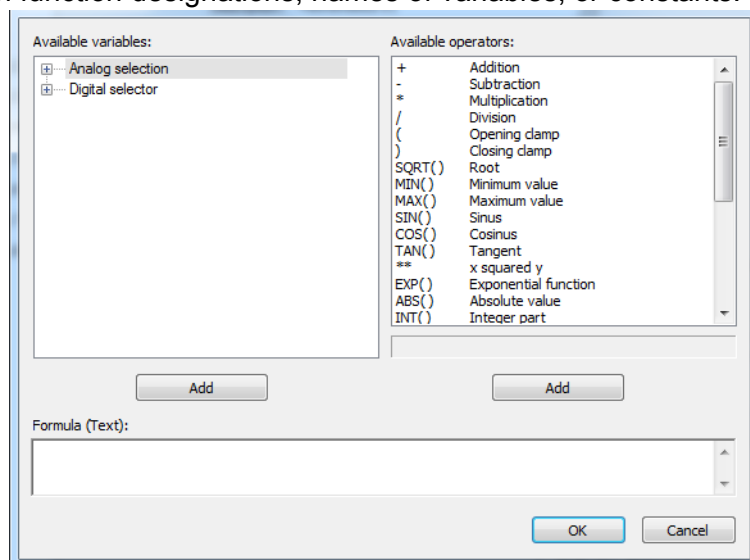

12 Configuration

12.16 Flags/service

12.16.1 Flags

Eight analog flags and 8 digital flags are available. The settings can be copied to another flag using the **COPY** button.

Setup dialog

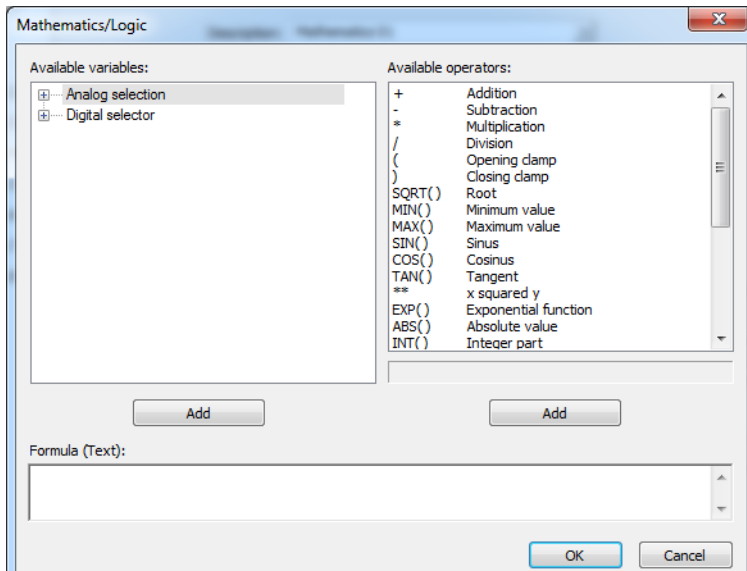

Analog flag parameters

Parameter	Selection/settings	Description
Analog flag	0.0000 to 100	Can be set within the limits of any value with four decimal places.
Temperature	None	
	Relative	
	Absolute	
Unit	%	Entry of a unit with up to five characters possible
Decimal place	Auto	Automatic switching
	XXXXX.	No decimal place
	XXXX.X	1 decimal place
	XXX.XX	2 decimal places
	XX.XXX	3 decimal places
X.XXXX	4 decimal places	
Measuring range start	0.0000 to 100	
Measuring range end	0.0000 to 100	

Digital flag parameters

Parameter	Selection/settings	Description
Digital flags 1 to 8	Off	Low (logic "0")
	On	High (logic "1")

12.16.2 Service

Here you can set which signal should be monitored, for example with a service counter. This can trigger an alarm if exceeded and can be acknowledged with the set signal.

Setup dialog

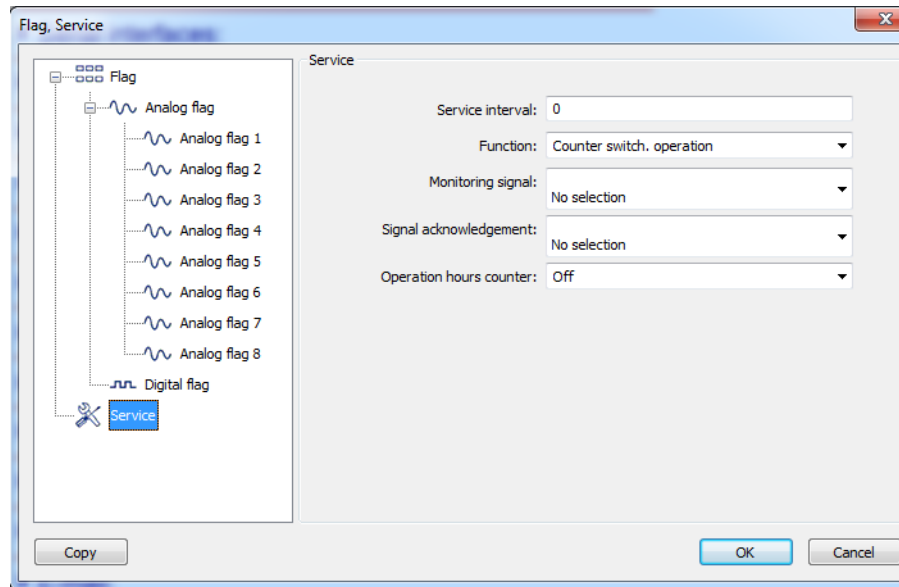

Parameter

Parameter	Selection/settings	Description
Service interval	0 to 99999	The number of switching operations for the set digital signal are counted.
Function	Switch operation counter	Switch operations are counted
	Time in hours	The hours in which the High signal (logic "1") appeared are counted.
	Time in days	The days in which the the High signal (logic "1") appear are counted.
Monitoring signal	No selection Digital selector	This signal is monitored using the service and if the alarm condition is exceeded (for example, the number of switch operations), the logic level switches from "0" to "1". The signal can be processed further in the digital selector.
Acknowledgement signal	No selection Digital selector	The elapsed service interval is acknowledged with this signal.
Operation hours counter	Off Display in hours Display in days	

12 Configuration

12.17 External digital inputs

Eight external digital inputs are available. The settings can be copied to another input using the **COPY** button. The settings can be copied to another external input using the **COPY** button.

Setup dialog

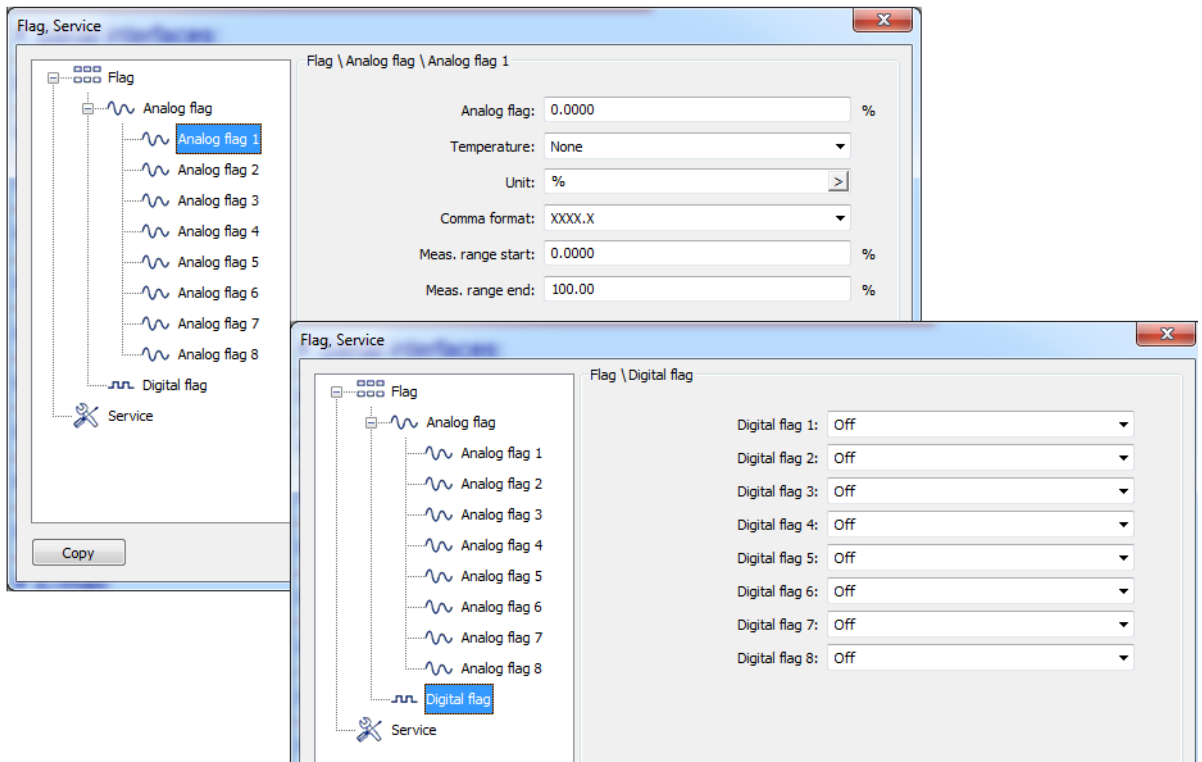

Parameter

Parameter	Selection/settings	Description
Channel description	ext. DE 01	
Secure power off	No Yes	- Status is secured beyond power failure.
Alarm type	Off	
Polarity for alarm		
Alarm text	Ext. digital alarm 01	

12.18 External analog inputs

Eight external analog inputs are available. The settings can be copied to another input using the **COPY** button.

Setup dialog

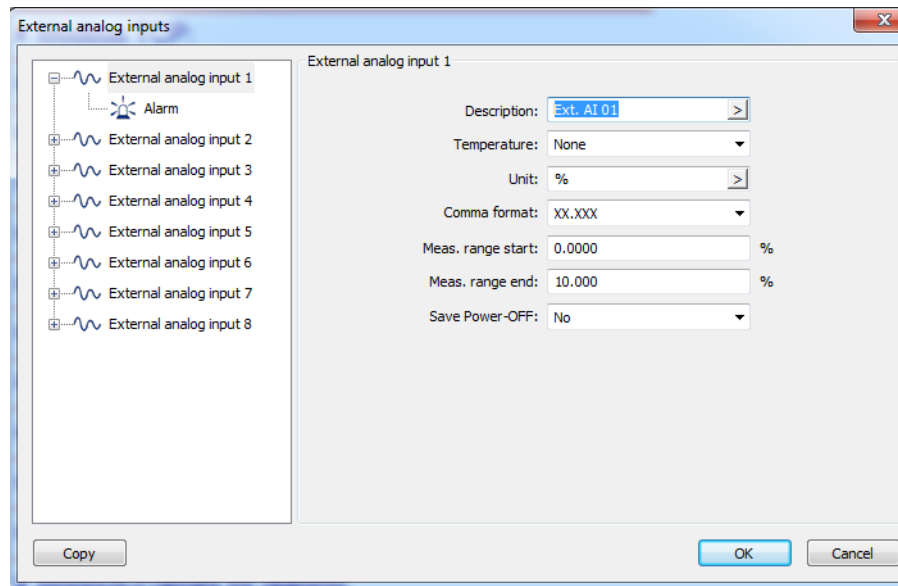

Parameter

Parameter	Selection/settings	Description
Designation	Ext. AE 01	
Temperature	None Relative Absolute	
Decimal place	Auto XXXXX. XXXX.X XXX.XX XX.XXX X.XXXX	Automatic switching No decimal place 1 decimal place 2 decimal places 3 decimal places 4 decimal places
Measuring range start	0.0000	
Measuring range end	100.00	
Secure power off	No Yes	Status is secured beyond power failure.

12 Configuration

12.18.1 Alarms

Setup dialog

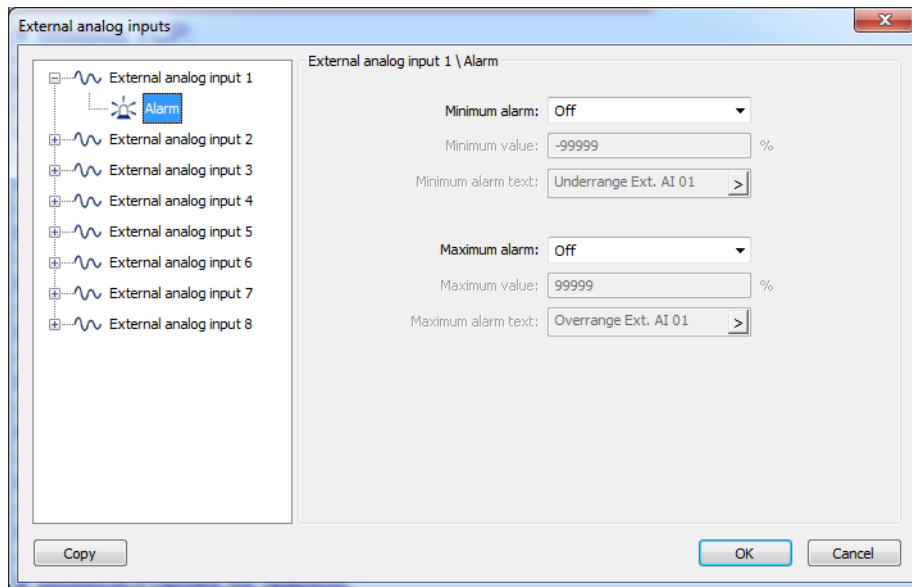

Parameter

Parameter	Selection/settings	Description
Minimum alarm	Off	Alert switched off.
	Alarm	A message will be entered in the alarm list depending on the minimum value that has been set.
	Event	A message will be entered in the events list depending on the minimum value that has been set.
Minimum value	-99999 to 99999	In the event of deviation below the limit values, an alarm/event will be entered.
Minimum alarm text	Underrange ext. AE 01	20 characters of editable text
Maximum alarm	Off	Alert switched off.
	Alarm	A message will be entered in the alarm list depending on the maximum value that has been set.
	Event	A message will be entered in the events list depending on the maximum value that has been set.
Maximum value	-99999 to 99999	In the event of deviation above the limit values, an alarm/event will be entered.
Maximum alarm text	Overrange ext. AE 01	20 characters of editable text

12.19 Serial interfaces

One serial interface is available by default. If additional serial interfaces should be added in the form of optional boards, they will appear here.

Setup dialog

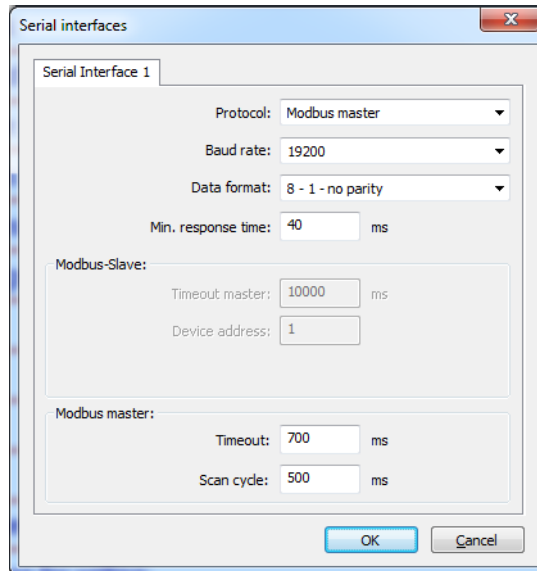

Parameter

Parameter	Selection/settings	Description
Protocol	Modbus slave	
	ER8	
	Modbus master	
Baud rate	9600, 19200, 38400	
Data format	8 - 1- no parity	
Minimum response time	0 to 40 to 500 ms	Minimum response time required.
Master timeout	60 to 10000 to 60000	
Device address	1 to 254	
Timeout	60 to 700 to 10000	
Scan cycle	60 to 500 to 99999	

12 Configuration

12.20 Modbus TCP

There is no Modbus TCP interface available by default. If it is integrated into the device using optional boards, the following values should be set for Modbus communication:

Setup dialog

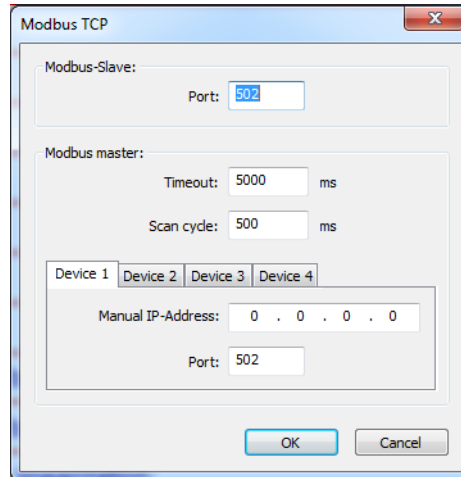

Parameters for Modbus slave

Parameter	Selection/settings	Description
Port	0 to 502 to 1024	

Parameters for Modbus master

Parameter	Selection/settings	Description
Timeout	4000 to 5000 to 10000	
Scan cycle	0 to 500 to 1024	
Device 1	0.0.0.0 ... 255.255.255.255	
Device 2	0.0.0.0 ... 255.255.255.255	
Device 3	0.0.0.0 ... 255.255.255.255	
Device 4	0.0.0.0 ... 255.255.255.255	
Manual IP address	0.0.0.0 ... 255.255.255.255	
Port	0 to 502 to 1024	

12.21 Relay module (accessories)

An ER8 external relay or logic module can be connected at the serial interface COM1. Relays 1 to 8 can be controlled using the digital selector.
The relay module is switched to inactive by default:

Setup dialog

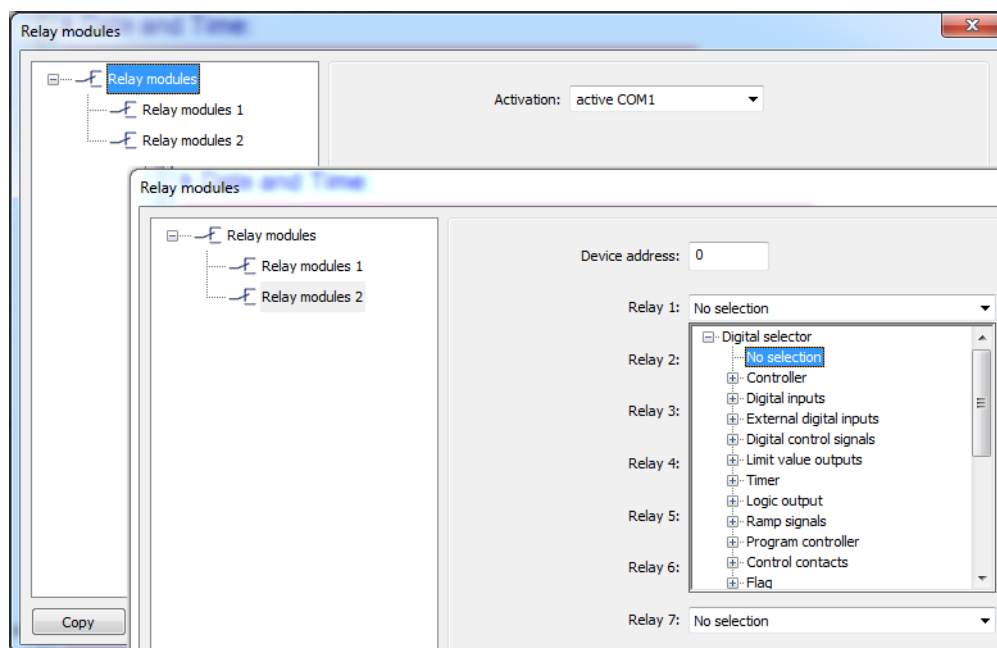

Parameter

Parameter	Selection/settings	Description
Activation	Inactive COM1 active COM2 active	Not activated The external relay module is connected and activated at this interface. (only if the interface is integrated as an option)
Device address	0 to 255	
Relay 1 Relay 2 Relay 3 Relay 4 Relay 5 Relay 6 Relay 7 Relay 8	No selection Digital selector	- This signal is issued on the ER8 relay

12 Configuration

12.22 PROFIBUS DP (option)

For a device with integrated PROFIBUS DP, optional boards can adopt the following settings:

Setup dialog

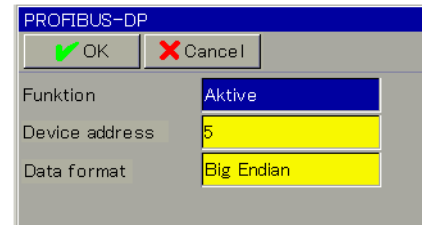
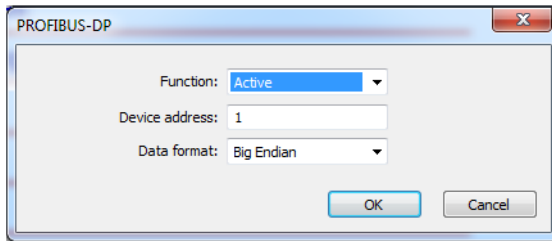

Parameter

Parameter	Selection/settings	Description
Function	Inactive	PROFIBUS inactive (bus error message suppressed)
	Active	PROFIBUS active
Device address	0 to 127	-
Device address	1 to 125	May be used for the connected devices
Data format	Big Endian	Also known as "Motorola format"
	Little Endian	Also known as "Intel format"

13 Configuration – in setup program only

13.1 Installing the setup program

Insert the CD and the setup program will start automatically.
Follow the instructions on the screen.

13.1.1 Hardware

- 500 MB hard disk space
- 512 MB RAM

13.1.2 Software requirements

- Microsoft Windows XP
- Microsoft Windows7 32 or 64-bit

13.2 Starting the setup program

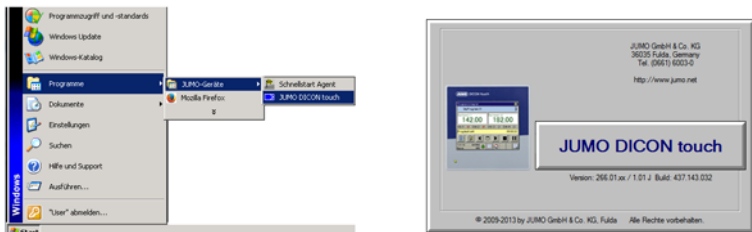
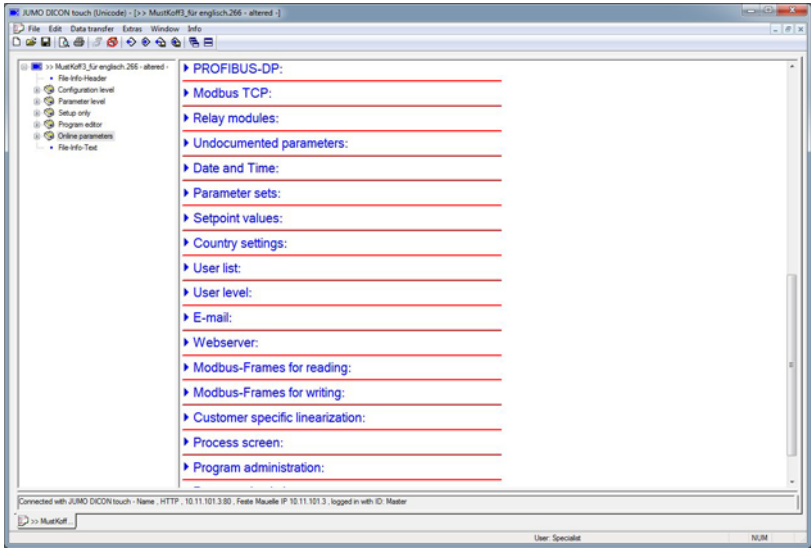
Step	Activity
1	<p>Start the program by selecting it from the start menu and the version display will appear briefly.</p>  <p>The image shows a Windows Start menu with 'JUMO DICON touch' selected under the 'Programme' category. To the right is a splash screen for 'JUMO DICON touch' with version information: 'Version: 266.01.01 / 1.01.2 Build: 437.143.032'.</p>
2	<p>The main window appears and the program can be run.</p>  <p>The image shows the main configuration window of 'JUMO DICON touch'. The window title is 'JUMO DICON touch [Unicode] - [MusterKaff3_für_englisch_266 - altered -]'. The left sidebar contains a tree view with 'File Info-Header', 'Configuration level', 'Parameter level', 'Setup only', 'Program editor', and 'Online parameters'. The main area lists various configuration options with expandable arrows: PROFIBUS-DP, Modbus TCP, Relay modules, Undocumented parameters, Date and Time, Parameter sets, Setpoint values, Country settings, User list, User level, E-mail, Webservice, Modbus-Frames for reading, Modbus-Frames for writing, Customer specific linearization, Process screen, and Program administration. At the bottom, it shows 'Connected with JUMO DICON touch - Name: HTTP_10.11.101.3.80; Feste Mauele IP 10.11.101.3; logged in with ID: Master' and 'User: Specialist'.</p>

➔ Setup program started

13 Configuration – in setup program only

13.2.1 Establish the connection to the device

First of all, you will see from the connection symbol on the menu panel that a device has not yet been connected.

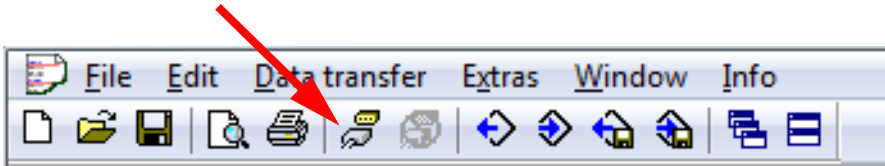

The following possibilities are available for connecting the device:

Via USB device interface

Step	Activity
1	Connect USB interfaces between the device and the PC
2	Click on CONNECT and the empty connection list will appear. Click on NEW ENTRY
3	Select the USB and click NEXT (no logon)
4	Select the USB connection and click Finish

➔ USB connection established

13 Configuration – in setup program only

Via Ethernet interface

Step	Activity
1	Connect Ethernet socket on the device with LAN socket on the router or company network and perform step 2 as with the USB interface
2	Select TCP/IP and click NEXT (no logon)
3	Enter IP address and click Finish

➔ LAN connection established

13.2.2 Setup data transfer on or from the external mass storage device

The setup program first saves the setup data on the internal hard disk drive, from which the setup program also runs.

However, setup data can also be exported/imported from the device or with the setup program using a mass storage device. The USB host socket is used for this purpose.

The devices can therefore be easily duplicated with identical firmware versions.

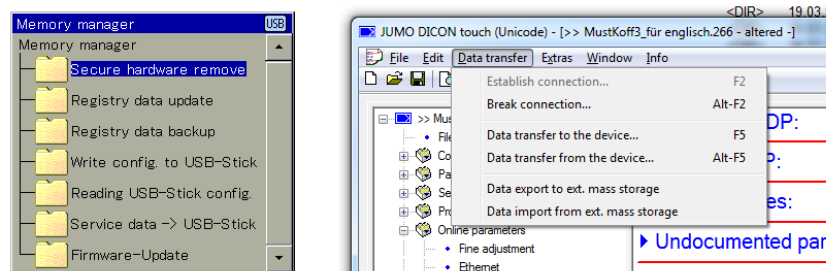

From the device	With the setup program
Write config. to USB stick	Setup data transfer from the device to an external mass storage device
Reading USB stick config.	Setup data transfer from the external mass storage device to the device

13 Configuration – in setup program only

13.3 Country settings

Additional device languages can be generated or edited here. For example, French can be selected as a second language from the current library and transferred to the device.

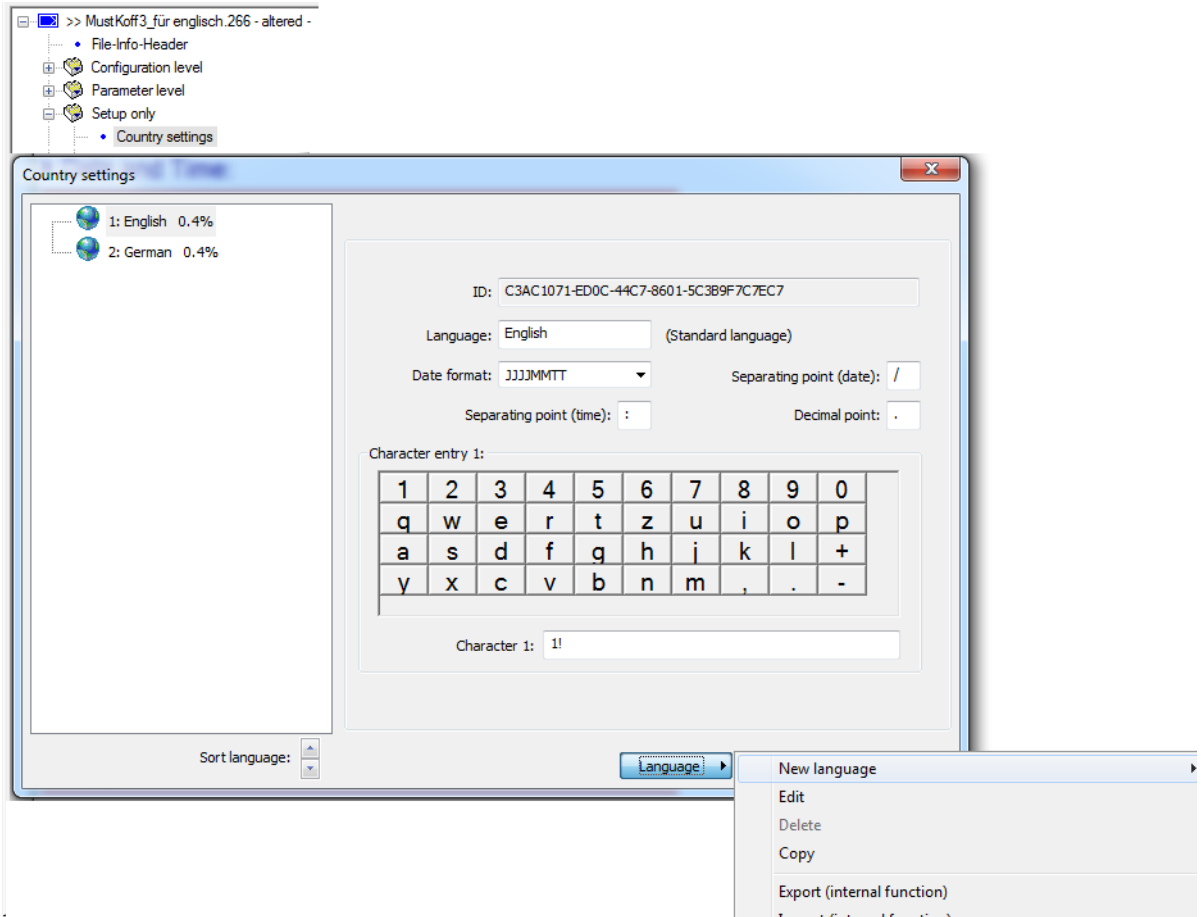

13.4 User list

The user currently logged on is displayed.

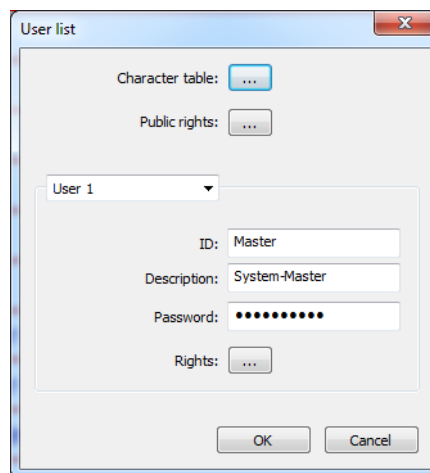

13 Configuration – in setup program only

13.5 User level

The user levels can only be edited using the setup program. An example of this can be seen in Chapter 7.1 "Example 4 Transferring controller setpoint values to the user level", page 45.

13.6 E-mail

Five different e-mail texts are entered here and sent to the plant, for instance, in the event of an alarm.

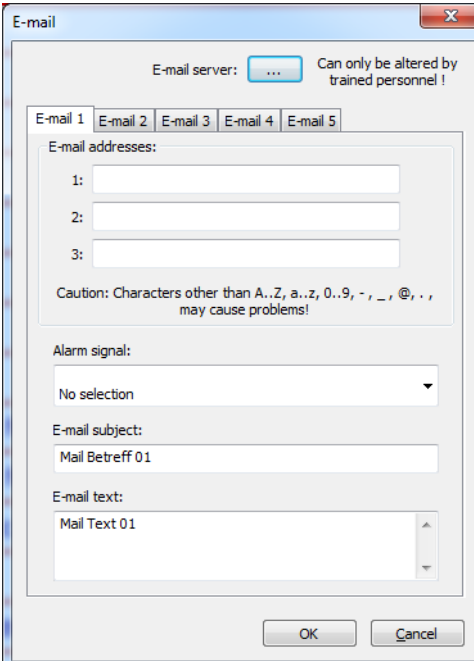

The screenshot shows a dialog box titled "E-mail" with a close button (X) in the top right corner. At the top, there is a label "E-mail server:" followed by a button with three dots and a note: "Can only be altered by trained personnel!". Below this is a tabbed interface with five tabs labeled "E-mail 1", "E-mail 2", "E-mail 3", "E-mail 4", and "E-mail 5". The "E-mail 1" tab is selected. Under the heading "E-mail addresses:", there are three input fields labeled "1:", "2:", and "3:". Below these fields is a caution message: "Caution: Characters other than A..Z, a..z, 0..9, -, _ , @, . , may cause problems!". Under the heading "Alarm signal:", there is a dropdown menu currently showing "No selection". Below that is the "E-mail subject:" field with the text "Mail Betreff 01". The "E-mail text:" field contains "Mail Text 01". At the bottom of the dialog are "OK" and "Cancel" buttons.

13.7 Web server

HTML documents, which can be created using a conventional HTML editor, can be stored in the JUMO DICON touch using the PC setup program. These documents can contain texts, graphics, and JavaScript code. Analog and digital values for the device can be displayed with JavaScript. The result is a website which can be retrieved over the Internet or LAN and displayed via a PC using a conventional web browser. On this website, the user can now see a clear display of the plant or the process, including measured values and operating states. A "standard online visualization" function is stored as default. A PC with Microsoft® Windows® operating system and Silverlight® installed is required to use this function. An HTML document can be created here which visualizes the DICON touch using a web application.

13 Configuration – in setup program only

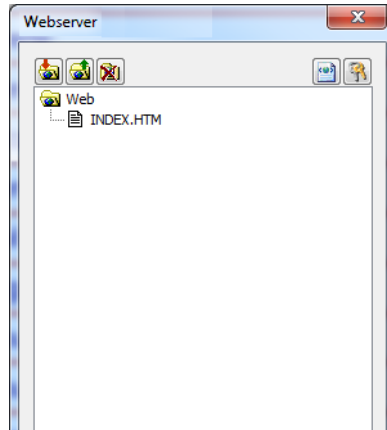

13.8 Modbus frames for reading

This function is used to compile up to eight Modbus frames for reading process values of external devices (via interface) individually for each opposite side. The process values (analog, integer, and digital values, and text) are written to the selected variables from the received Modbus telegram and are available for use in the system. Each frame can be used to configure up to 64 entries (variables); the process values are then grouped and transferred in a Modbus telegram.

Setup dialog

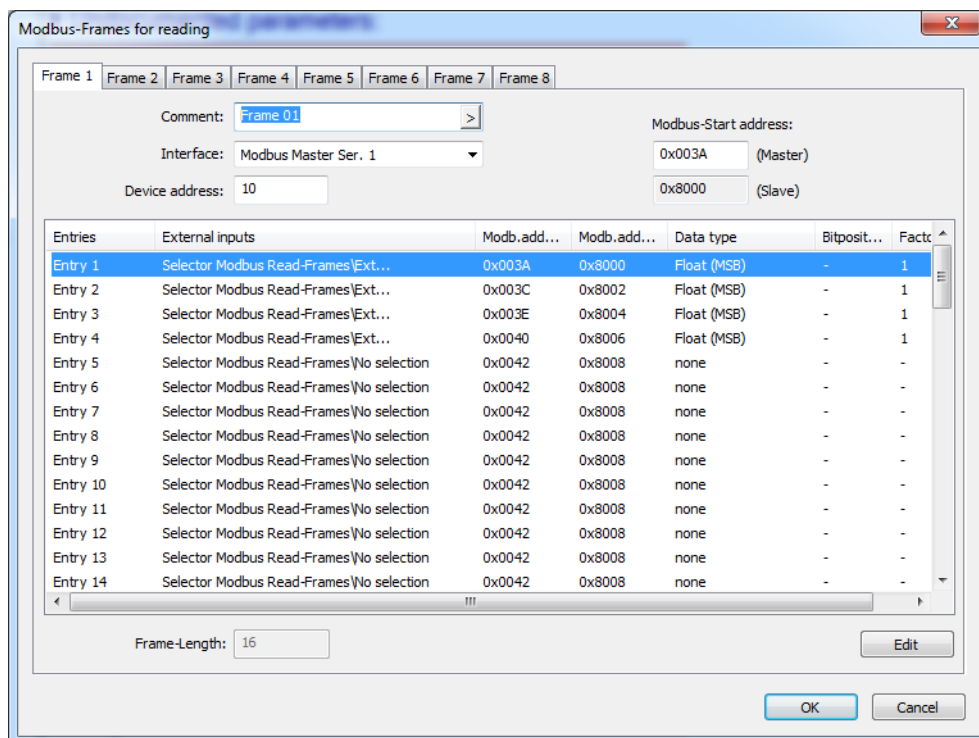

NOTE!

Configuration and use of the Modbus frames for writing is described in the Modbus interface description B 703571.2.0.

13 Configuration – in setup program only

13.9 Modbus frames for writing

This function is used to compile up to eight Modbus frames for writing process values to external devices (via interface) individually for each opposite side. The process values (analog, integer, and digital signals, and text) are written to the frames by the system and are available to external devices. Each frame can be used to configure up to 64 entries (process values), which are then grouped and transferred in a Modbus telegram.

Setup dialog

Entries	Process values	Modb.add...	Modb.add...	Data type	Bitposit...	Factr
Entry 1	Process value selector Digital select...	0x0074	0x8800	Integer (2 Byte)	0	-
Entry 2	Process value selector Digital select...	0x0075	0x8801	Integer (2 Byte)	0	-
Entry 3	Process value selector No selection	0x0076	0x8802	none	-	-
Entry 4	Process value selector No selection	0x0076	0x8802	none	-	-
Entry 5	Process value selector No selection	0x0076	0x8802	none	-	-
Entry 6	Process value selector No selection	0x0076	0x8802	none	-	-
Entry 7	Process value selector No selection	0x0076	0x8802	none	-	-
Entry 8	Process value selector No selection	0x0076	0x8802	none	-	-
Entry 9	Process value selector No selection	0x0076	0x8802	none	-	-
Entry 10	Process value selector No selection	0x0076	0x8802	none	-	-
Entry 11	Process value selector No selection	0x0076	0x8802	none	-	-
Entry 12	Process value selector No selection	0x0076	0x8802	none	-	-
Entry 13	Process value selector No selection	0x0076	0x8802	none	-	-
Entry 14	Process value selector No selection	0x0076	0x8802	none	-	-



NOTE!

Configuration and use of the Modbus frames for writing is described in the Modbus interface description B 703571.2.0.

13 Configuration – in setup program only

13.10 Customer-specific linearization

No linearization tables are stored by default.
 A maximum of four linearizations can be created with the setup program.

13.10.1 Grid points

Customer-specific linearization is specified by entering up to 40 grid points (pairs of values X/Y). Here, value X indicates the physical measured value (in mV, mA, or Ohm for example; depending on the sensor type) and value Y indicates the linearized value (temperature in °C, for example).

Setup dialog

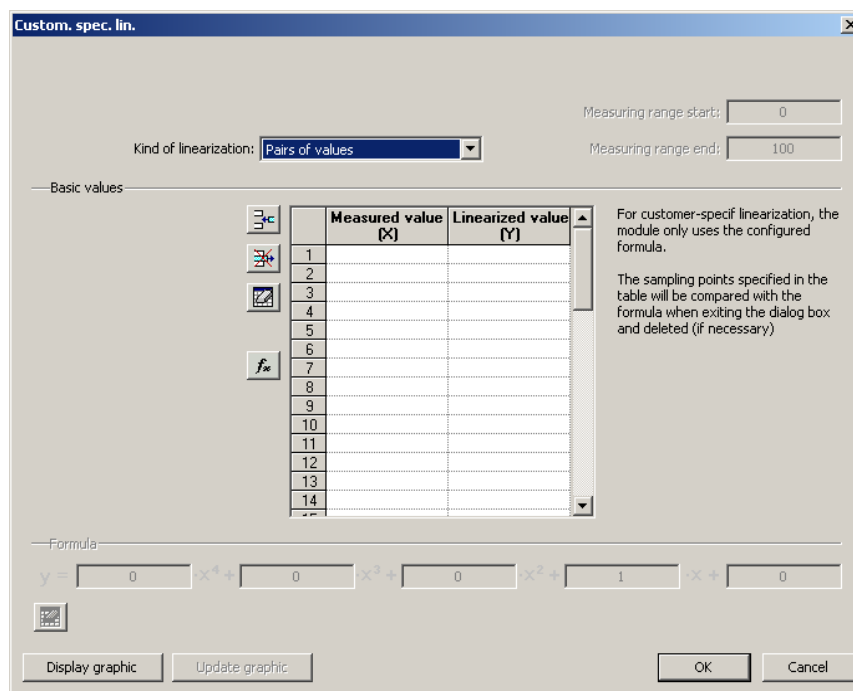

Parameter

Parameter	Selection/settings	Description
Measured value (X)	-99999 to 0 to +99999	Value of the relevant grid point on the x axis
Linearized value (Y)	-99999 to 0 to +99999	Value of the relevant grid point on the y axis

The definition range of linearization (measuring values, x axis) is monitored in the module and limited as follows:

Lower limit of the definition range = $X_{min} - 0.0125 \times (X_{max} - X_{min})$

Upper limit of the definition range = $X_{max} + 0.03125 \times (X_{max} - X_{min})$



NOTE!

A measured value that lies outside of the definition range results in a deviation above or below the measuring range (out of range).

13 Configuration – in setup program only

Displaying linearization on a graphic ("Display graphic" button)

Use this button to create a graphic of the linearization.

The graphic includes the characteristic lines for both types of linearization where applicable, namely the grid points (table) and the formula.

The display range for the graphic is first of all determined by the smallest and largest grid points; it can be temporarily changed in the display by entering different x values.

Calculating the polynomial using the grid points ("fx" button)

After entering the pair of values, use this button to calculate a polynomial that describes the progression of the linearization characteristic line.

The calculated coefficients are incorporated into the formula. The characteristic lines for both types of linearization then correspond to each other.

If the x values do not increase in a straight line, the linearization will not be adopted. In this case, it will not be possible to display the graphic or calculate the polynomial.

13.10.2 Formula

Customer-specific linearization is specified using a 4th order polynomial. The polynomial is calculated for the entire linearization range.

Polynomial formula: $y = X4 \cdot x^4 + X3 \cdot x^3 + X2 \cdot x^2 + X1 \cdot x + X0$

Setup dialog

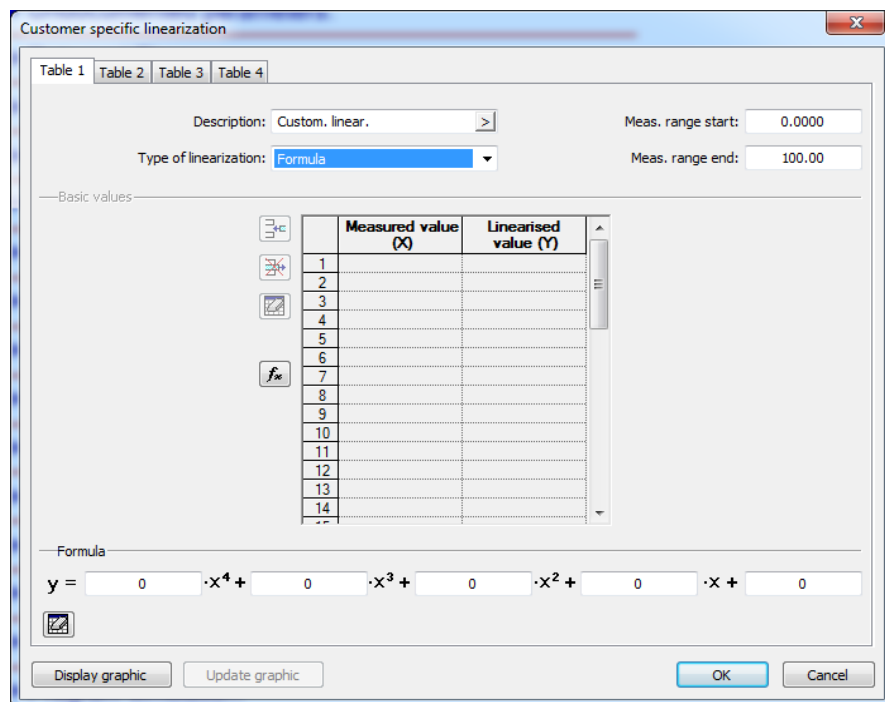

Parameter

Parameter	Selection/settings	Description
Measuring range start (Ymin)	-99999 to 0 to +99999	Start value of the y axis

13 Configuration – in setup program only

Parameter	Selection/settings	Description
Measuring range end (Ymax)	-99999 to 100 to +99999	End value of the y axis
X0	-99999 to 0 to +99999	Absolute component of the polynomial (point of intersection with the y axis)
X1	-99999 to 1 to +99999	Coefficient of the linear component (x)
X2	-99999 to 0 to +99999	Coefficient of the quadratic component (x ²)
X3	-99999 to 0 to +99999	Coefficient of the cubic component (x ³)
X4	-99999 to 0 to +99999	Coefficient of the quartic component (x ⁴)

The value range for the linearization (linearized values, y axis) is monitored in the module and limited as follows:

Lower limit of the value range = Ymin - 0.0125 × (Ymax - Ymin)

Upper limit of the value range = Ymax + 0.03125 × (Ymax - Ymin)



NOTE!

A linearized value that lies outside of the value range results in a deviation above or below the measuring range (out of range).

Displaying linearization on a graphic ("Display graphic" button)

Use this button to create a graphic of the linearization.

The graphic includes the characteristic lines for both types of linearization where applicable, namely the formula and the grid points (table).

The display range for the graphic is first of all determined by the "measuring range start" and "measuring range end" values (y values); it can be temporarily changed in the display by entering different x values

Example of third-order polynomial

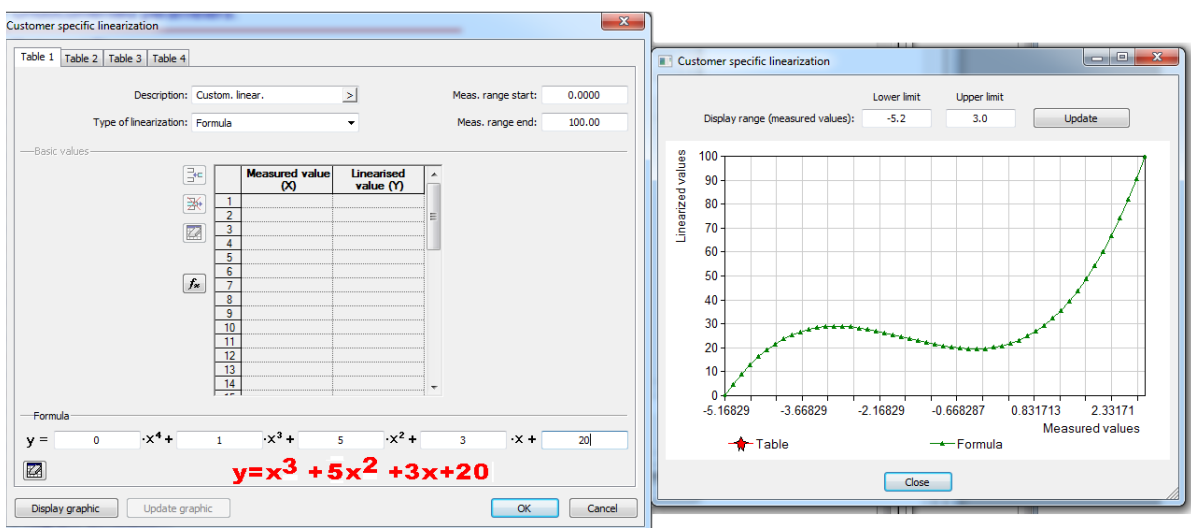

13 Configuration – in setup program only

13.11 Process screen

The process screen is empty by default and can only be created using the setup program.

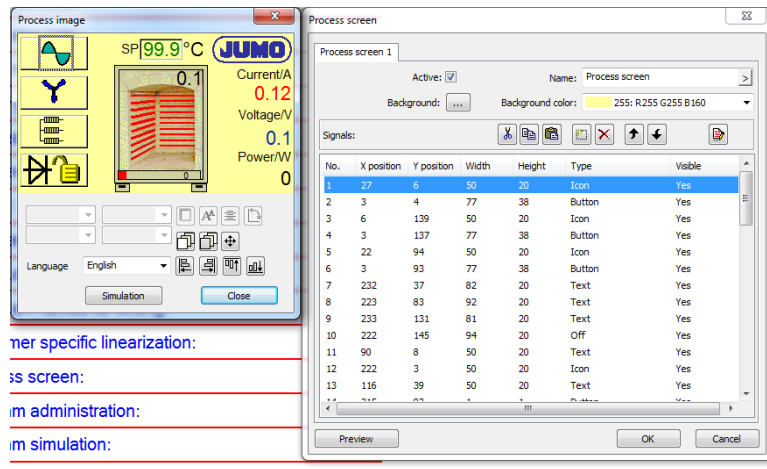

A process screen can consist of a maximum of 50 objects. These could be icons in bitmap format, frames, surfaces, texts, and analog and digital values of various colors and sizes. The object background is always located right at the bottom. All other objects at the bottom of the list are covered by those at the top.

If a particular object is problematic, it can first be set to **VISIBLE>NO**.

Preview

In the list on the right-hand side, the position for screen elements is set and displayed on the left in the preview. Clicking on an object (highlighted in blue) causes it to appear in a frame on the left side of the preview window. You can also click in the preview window.



NOTE!

Before beginning the screen layout, icons and background screens must be contained in the library and in the "list of screens" (bitmap max. 320 x 182 pixel).

C:\Users\yourname\Documents\Set266u...

13 Configuration – in setup program only

13.11.1 Process screen editor

Setup dialog

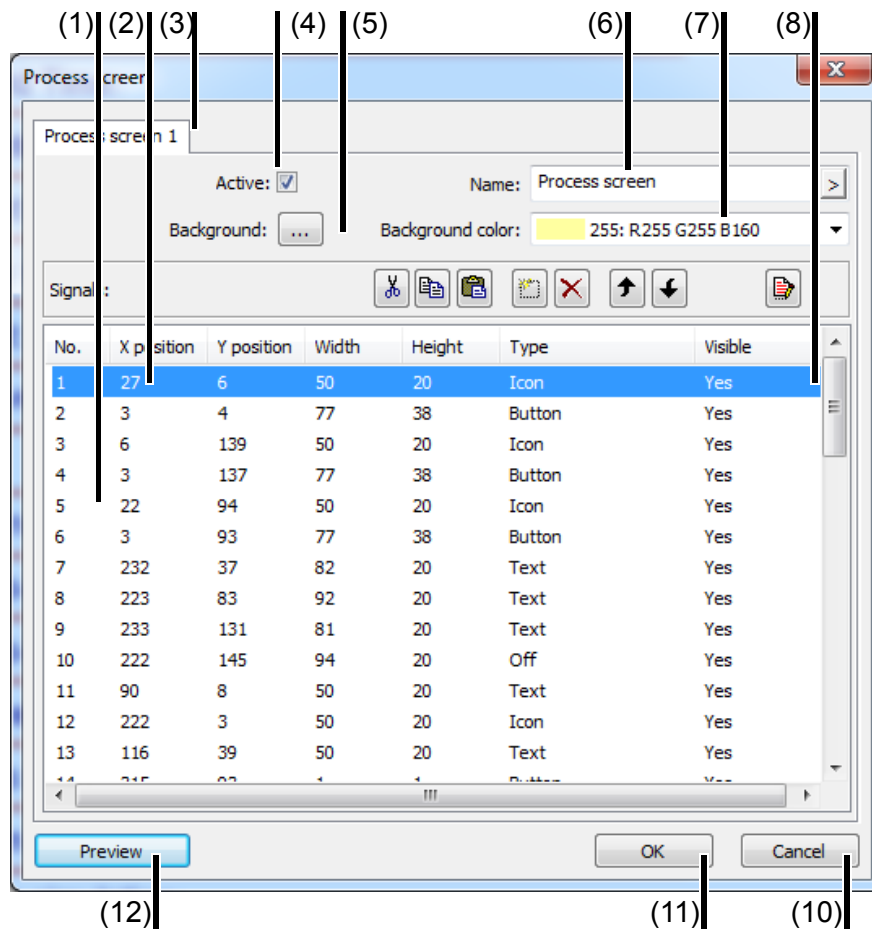





- (1) Object list
- (2) Object used
- (3) Selected process screen
- (4) Activate process screen
- (5) Select background image
- (6) Name of the process screen
- (7) Select background color
- (8) Navigation and processing functions
- (9) -
- (10) Exit process screen editor; settings are not adopted
- (11) Exit process screen editor; settings are adopted
- (12) Preview of the process screen (preview window is opened in the setup program)

Navigation and processing functions

Button	Function
	Cut object from the object list
	Copy object to another object (only within the same process screen)
	Paste cut object into the object list
	Add new object to the object list

13 Configuration – in setup program only

Button	Function
	Remove object from the object list
	Move object up in object list
	Move object down in object list
	Edit object

13.11.2 Background

In addition to the background color, a background image can also be used for the background of the process screen. The background image is selected from the list of available screens in the setup program. If the background color is to be visible, the background image must not cover the entire area of the process screen or it must be transparent (option when replacing a screen).

Example

A furnace whose temperature is regulated via an SCR power controller should be displayed here. For this purpose we need a screen of the plant with the most important parameters.

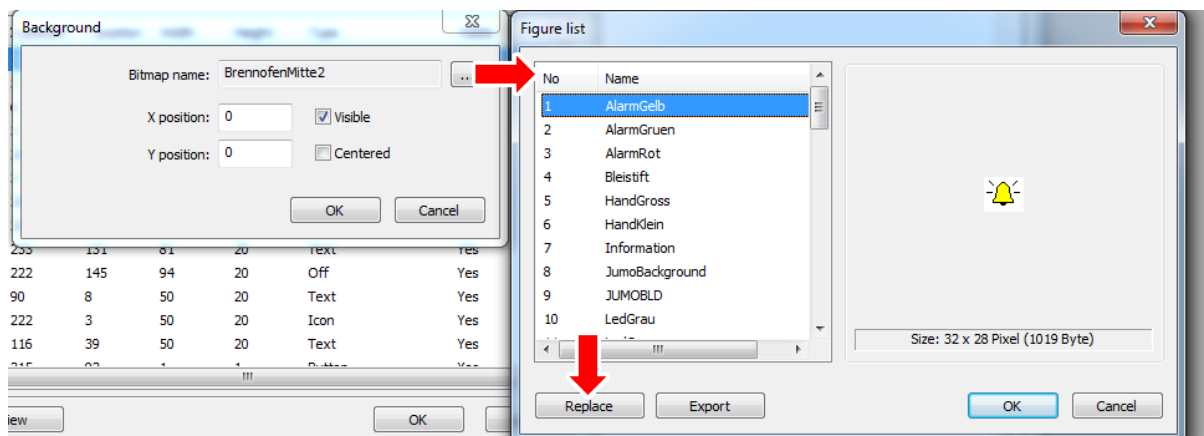

Assign screen name, click on "Visible", click ... , click "Replace"

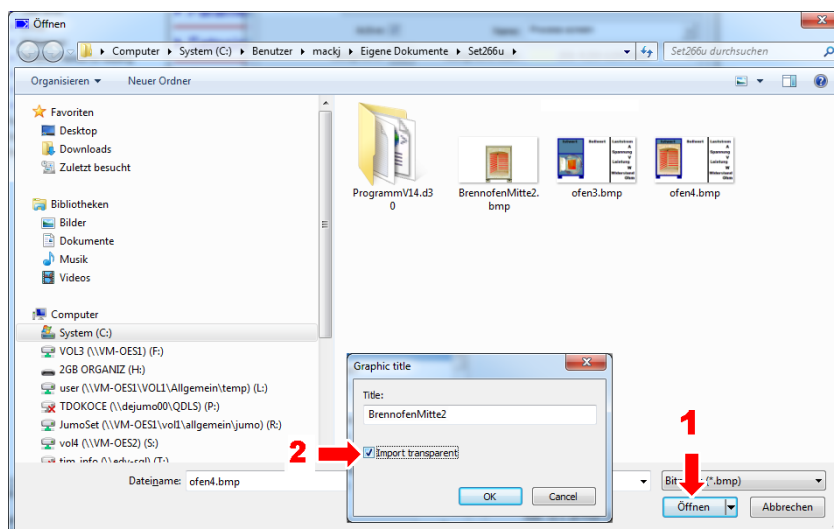

13 Configuration – in setup program only

Select the new furnace screen, click "Transparent" and it will appear in the list of screens.

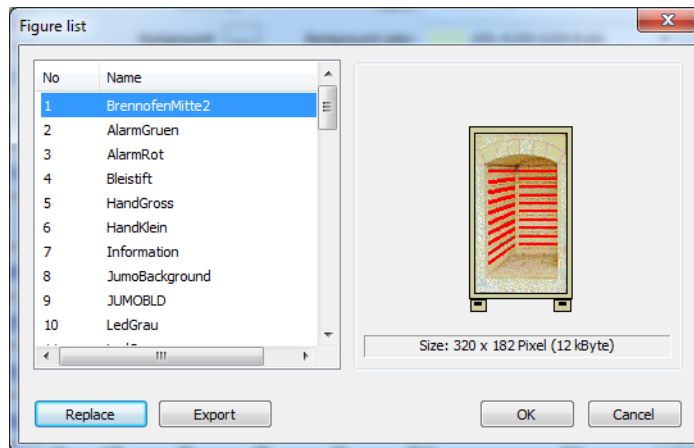

Once "Active" is ticked, the background screen will appear in the preview.

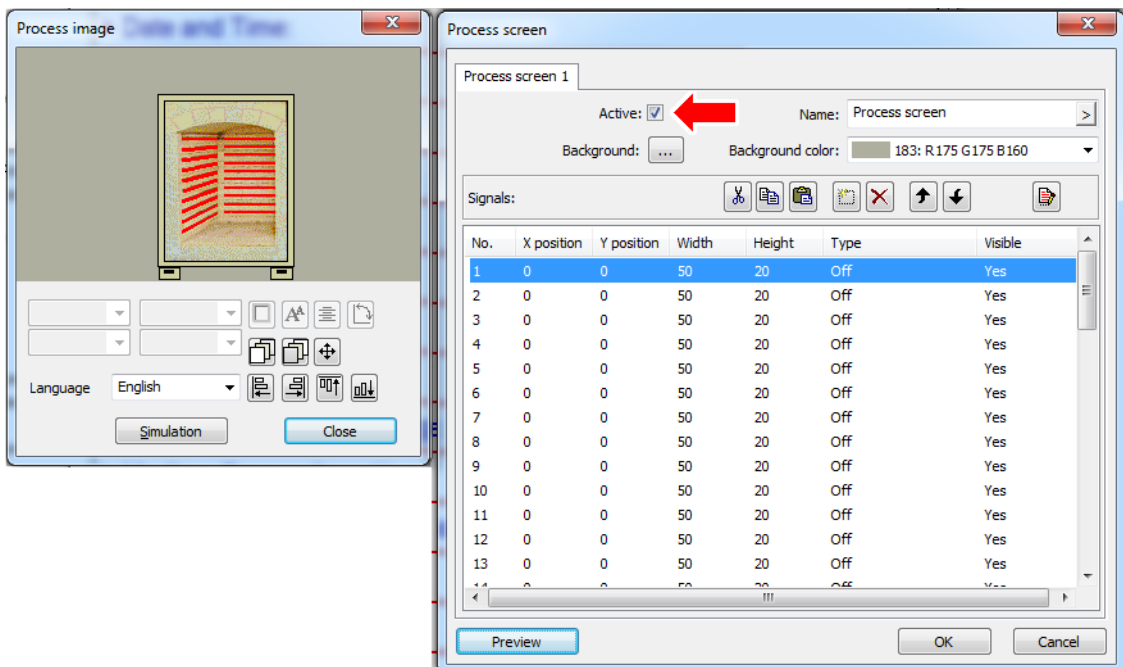

13 Configuration – in setup program only

13.11.3 Signal types for process screens (overview)

The variables and icons are now entered in the list until the process screen is complete. The first blue highlighted entry is highlighted in a blue frame in the preview.

Setup dialog

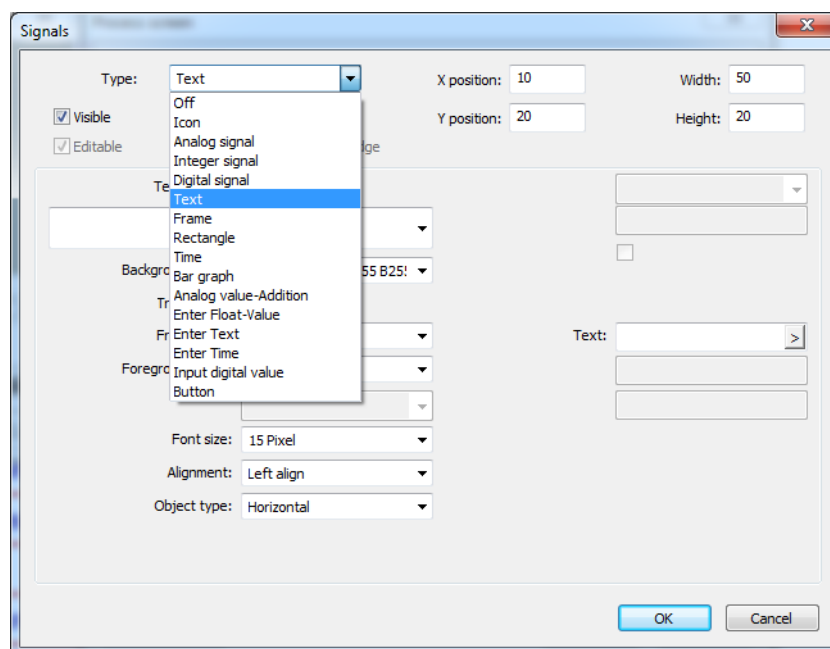

Signal types

Parameter	Description
Pictogram	Screwdriver, alarm bell...
Analog signal	...from the analog selector
Integer signal	...from the integer selector
Digital signal	...from the digital selector
Text	Text from the process or configuration selector
Frame	Transparent border
Rectangle	Rectangle with color fill and border
Time	Run times, timer times, service times
Bar graph	...from the analog selector
Extra analog value	Unit, channel description, min or max limit value
Float value input	Field for entering a floating point value
Text input	Field for entering a text
Time input	Field for date and time input
Digital value input	Field for binary value output
Button	Button with touch function

13 Configuration – in setup program only

13.11.4 General object features

The description of the general object features applies for all object types for which the parameters in question are available.

The specific object features are described in the following chapters under the corresponding object type.

Setup dialog

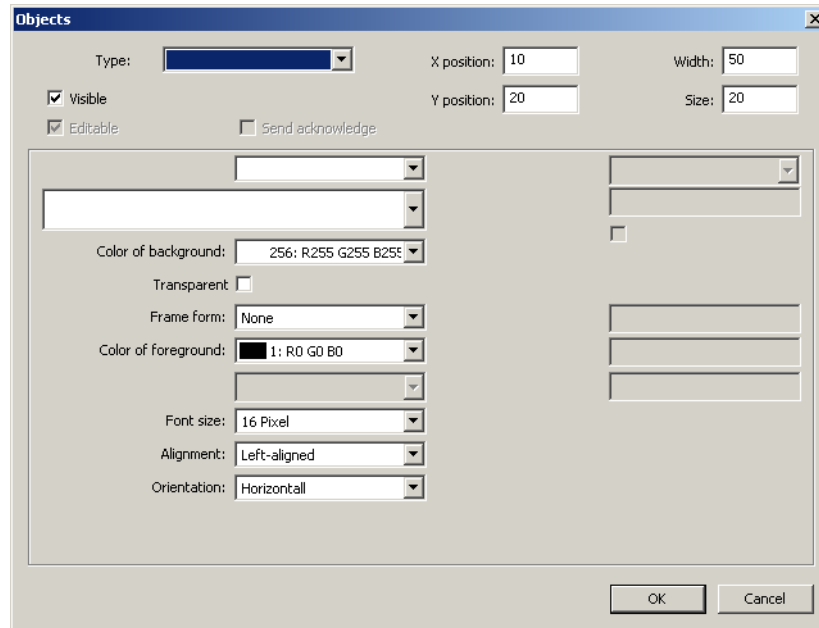

Parameter

Parameter	Selection/settings	Description
Type	Selection from list of object types	Object type for the process screen
X position	0 to 10 to 634	X coordinate of the upper left corner of the object in the process screen
Y position	0 to 20 to 402	Y coordinate of the upper left corner of the object in the process screen
Width	1 to 50 to 635	Width of the object
Height	1 to 20 to 403	Size of the object
Visible	Yes (), No () <input checked="" type="checkbox"/> <input type="checkbox"/>	"Yes" releases the display of the object in the process screen.
Editable	Yes (), No () <input checked="" type="checkbox"/> <input type="checkbox"/>	"Yes" releases the option for entry in the process screen (only for input objects).
Send acknowledgement	Yes (), No () <input checked="" type="checkbox"/> <input type="checkbox"/>	"Yes" means that an acknowledgement is sent to the internal PLC following an entry in the process screen (only for input objects with a destination variable).
Background color	Select color (drop-down menu).	Background color of the object

13 Configuration – in setup program only

Parameter	Selection/settings	Description
Transparent	Yes (<input type="checkbox"/>) , No (<input checked="" type="checkbox"/>) <input type="checkbox"/>	If "Yes", the background color of the object is not active. Instead, the font will be displayed in front of the background color of the process screen.
Frame type	Select form (drop-down menu).	The object can be provided with a frame.
Foreground color 	Select color (drop-down menu).	Font color within the object
Font size	Select font size (drop-down menu).	Font size within the object
Alignment	Select alignment (drop-down menu).	Alignment of the font within the object (left-aligned, right-aligned, centered)
Orientation (object type)	Select orientation (drop-down menu).	Orientation of the object in the process screen (horizontal, vertical; not for input objects).

Foreground color

In order for the font to be visible, the foreground and background color must be different from each another. If the "Transparent" setting is selected () , this applies with regard to the background color of the process screen.

13.11.5 Preview screen

A process screen that has been created can be inspected and changed in the preview screen using the setup program prior to being transferred to the device.





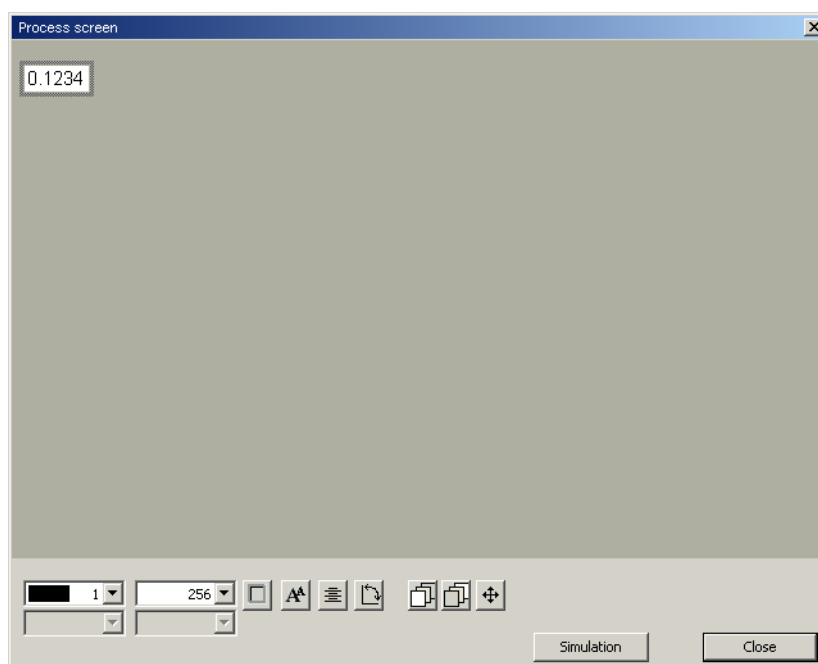

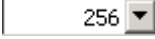

The preview screen is opened by touching the "Preview" button:

Preview screen



13 Configuration – in setup program only

Processing functions

Button	Function
	Select background color (for example, font color) within the object (drop-down menu).
	Select background color of the object (drop-down menu).
	Changing the frame form of the object (none, thin, thick, raised, sunken).
	Change font size (12, 16, 24, 31, 48, 64 pixels).
	Change alignment of the font within the object (left-aligned, centered, right-aligned).
	Change orientation of the object in the process screen (horizontal, vertical).
	Move object in process screen forward one level with each click. The object is simultaneously moved down in the object list (larger number).
	Move object in process screen back one level with each click. The object is simultaneously moved up in the object list (smaller number).
	Move object in process screen horizontally or vertically. Clicking on this button opens an additional window. This contains different arrows (buttons) for moving the object in preset steps.

Processing object features

Changes can be made directly to the object features in question using the processing functions described above. It is also possible to open the object by double-clicking (in the preview screen or in the object list) in order to process the object features.

Moving objects

The user has the following options for moving an object in the preview screen:

- Double-clicking the object to open it and changing the X/Y position.
- Left-clicking and holding the object and moving it directly into the preview screen.
- Moving the object using the arrows.

Foreground color

In order for the font to be visible, the foreground and background color must be different from each another. If the "Transparent" setting is selected (), this applies with regard to the background color of the process screen.

13.11.6 Transfer process screen to device

As soon as the setup data is transferred to the device, it can be retrieved from the operating loop.

14.1 Calibrating the touchscreen

The display on the TFT screen may no longer correspond to the points of contact on the adhesive touchscreen cover.

In this case, the touchscreen must be calibrated.

DEVICE MENU>CALIBRATE TOUCHSCREEN

To do this, four interchangeable screen points must be treated as accurately as possible with a pen wherever an 'x' appears.

The device saves these coordinates and this enables the assignment of the TFT screen and the touchscreen to correspond again.

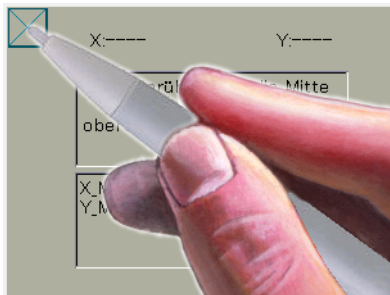

14 Special functions

15.1 Fine adjustment

You can use customer-specific fine adjustment to correct the measured values of the analog input. In contrast to offsetting, which is used to specify a constant correction value for the entire characteristic line, fine adjustment can also be used to change the gradient of the characteristic line.

Setup dialog

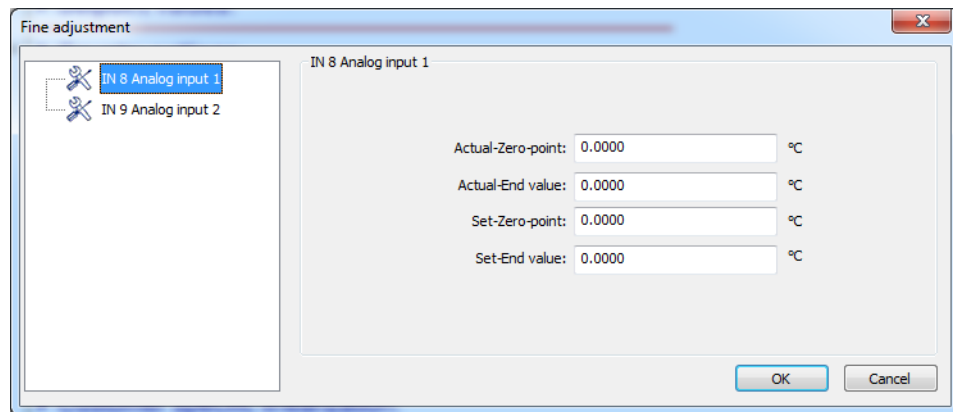

Parameter

Parameter	Selection/settings	Description
Actual zero point	-99999 to 0 to +99999	Lower displayed value
Actual end value	-99999 to 0 to +99999	Upper displayed value
Set zero point	-99999 to 0 to +99999	Lower reference value
Set end value	-99999 to 0 to +99999	Upper reference value

Example

The temperature inside a furnace is measured with an RTD temperature probe and displayed. Due to the temperature drift of the probe, the true temperature (reference measurement) deviates from the displayed value. The amount of deviation is different at the upper and lower measuring points, meaning that measured value offset is not suitable.

Actual zero point: 15 °C (lower displayed value)

Set zero point: 20 °C (lower reference value)

Actual end value: 70 °C (upper displayed value)

Set end value: 80 °C (upper reference value)

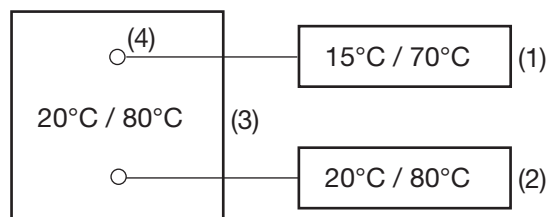

(1) Display values

(3) Furnace

(2) Reference values

(4) Sensor in RTD temperature probe

15 Online parameter

Performing fine adjustment

- 1) Determine the lower value (as low and constant as possible) with the reference measuring device.
Example: Set furnace temperature to 20 °C.
- 2) Enter the display value as the actual zero point and the reference value as the set zero point.
Example: Enter 15 and 20.
- 3) Determine the upper value (as high and constant as possible) with the reference measuring device.
Example: Increase furnace temperature to 80 °C.
- 4) Enter the display value as the actual end value and the reference value as the target end value.
Example: Enter 70 and 80.

Characteristic line

The following diagram shows the changes in the characteristic line caused by the fine adjustment (point of intersection with the x axis as well as the gradient).

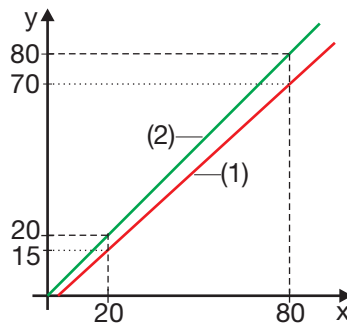

y Display value
x Reference value

(1) Characteristic line before fine adjustment
(2) Characteristic line after fine adjustment

Resetting the fine adjustment

The following settings must be made to reverse the fine adjustment:
Actual zero point = set zero point
Actual end value = set end value

15.2 Ethernet (option)

There is no Ethernet interface available by default. If it is integrated into the device using optional boards, the following values should be set:

Setup dialog

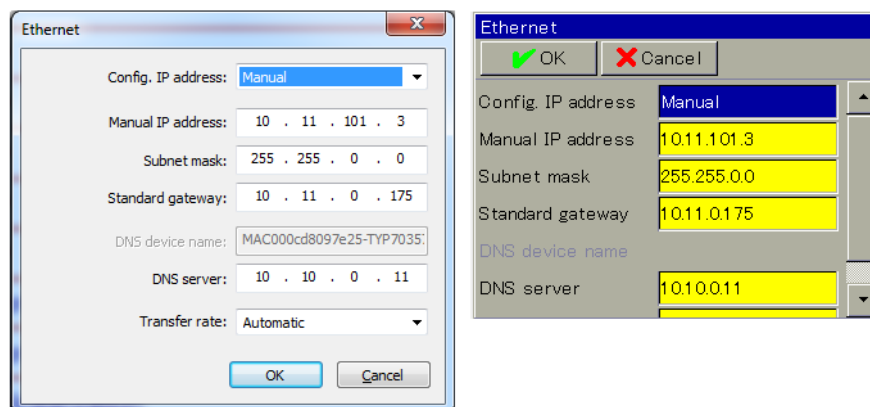

Parameter

Parameter	Selection/settings	Description
IP address assignment	Automatic Manual	The DICON touch automatically obtains its IP address from the DHCP server. The IP address for the DICON touch must be assigned manually.
Manual IP address	0.0.0.0 ... 233.233.233.1... 255.255.255.255	The IP address is entered manually here (if necessary, it should be requested from the administrator responsible).
Subnet mask	0.0.0.0 ... 255.255.255.0... 255.255.255.255	Manual setting of the subnet mask
Standard gateway	0.0.0.0 ... 255.255.255.255	Manual setting of the IP address of the standard gateway (router)
DNS device name	097e25-TYP703571 Admissible characters: a to z, A to z, -, 0 to 9 (max. 63 characters); name must begin with a letter and may not end with a "-" (hyphen)	Example of unique DNS device name for multifunction panel (assigned by default)
DNS server	0.0.0.0 ... 255.255.255.255	IP address of DNS server
Transfer rate	Automatic 10 MBit/s half duplex 10 MBit/s full duplex 100 MBit/s half duplex 100 MBit/s full duplex	Data transfer rate of Ethernet connection

15 Online parameter

15.3 Date and time

The date and time for the device can be adopted from the connected PC or even entered manually.

Setup dialog

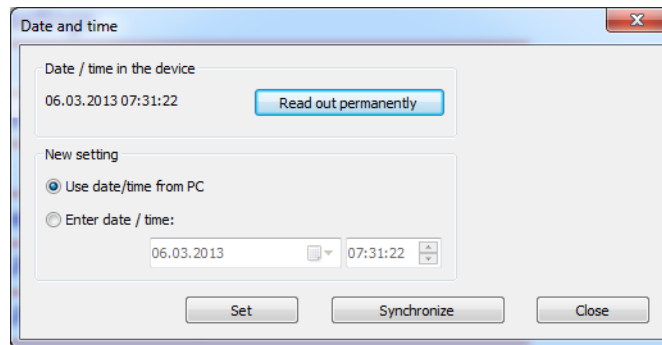

15.4 Screenshot

A screenshot can be created here from the current device and saved as a bitmap.

Setup dialog

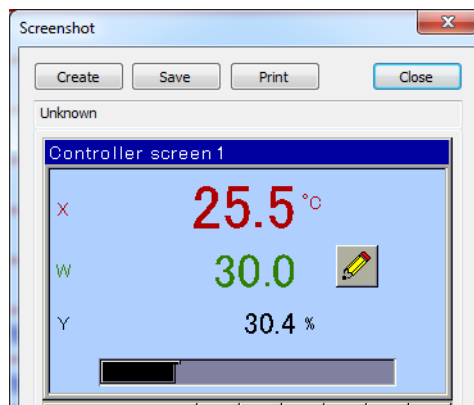

15.5 Deleting measurement data memory

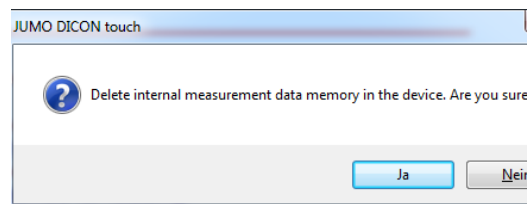

A screenshot can be created here from the current device and saved as a bitmap.

Setup dialog

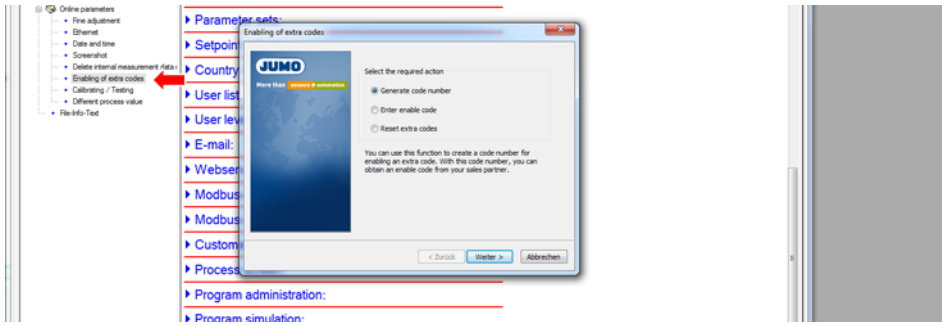
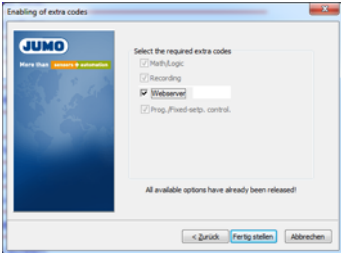

15.6 Enabling of extra codes

To do this, you need a device that is connected to the setup program.

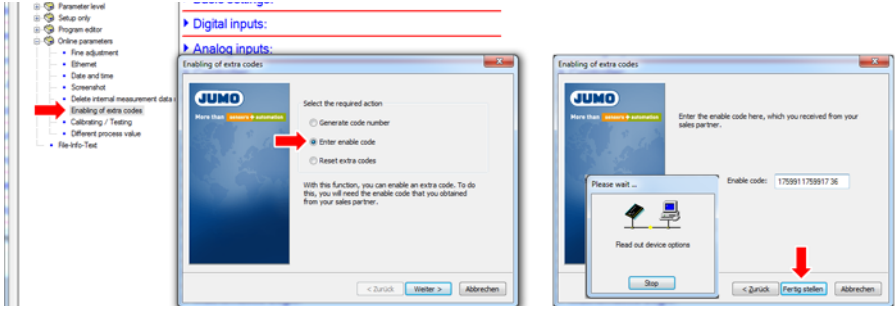
Step	Activity
1	Connect device to the PC using the USB or LAN
2	Click on ENABLING OF EXTRA CODES 
3	Generate code number and click Next
4	Select the required extra codes and click Next 
5	Code number appears 
6	Send the code number to JUMO and the enabling code will be sent to you.
7	Enter the enabling code under ENABLING OF EXTRA CODES and click Next. 

➔ Extra code enabled

15 Online parameter

15.7 Testing calibration

This is where the dialogs for calibration and testing of analog and digital outputs appear, along with other device functions.

Setup dialog

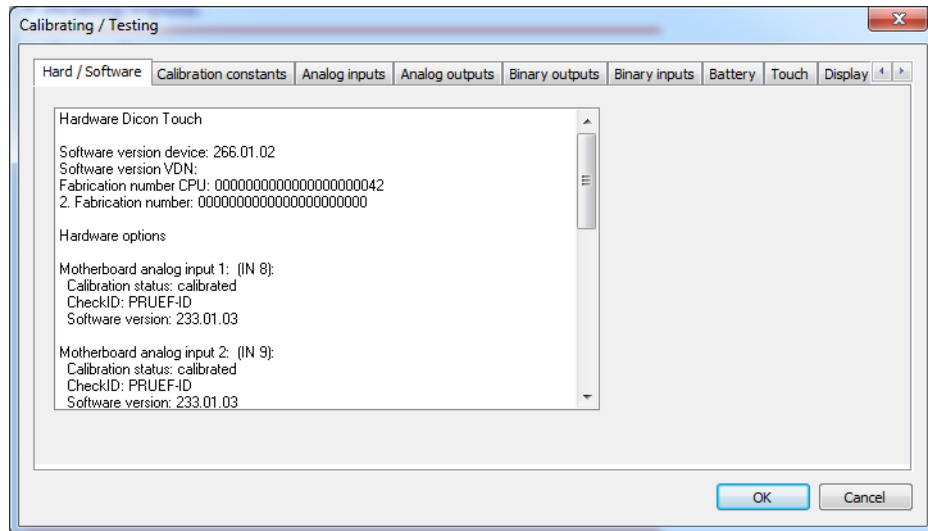

15.8 Various process values

Values can be read and saved here.

Setup dialog

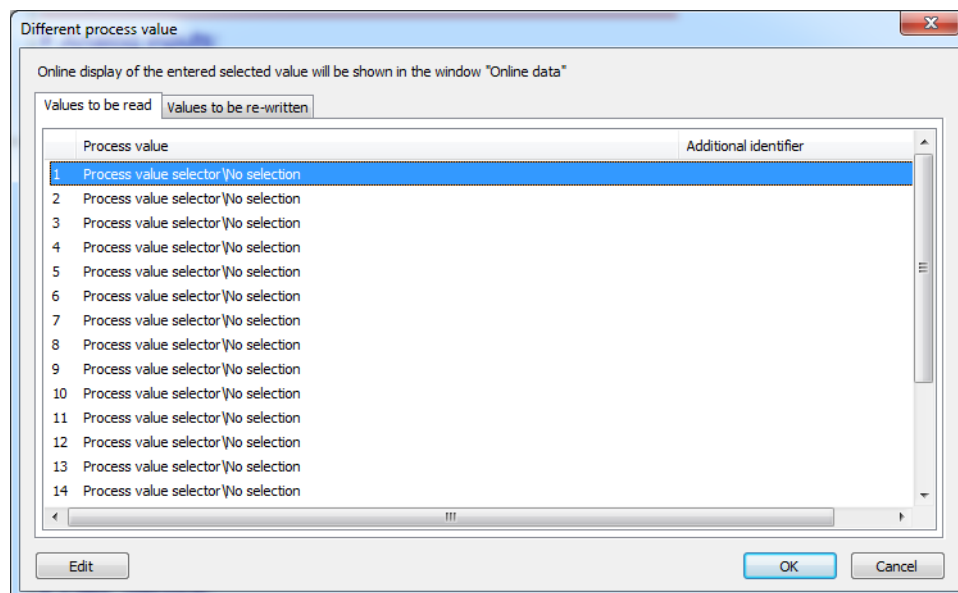

16.1 Error messages in float values and on the display

The display is shown as a float value itself. The following statuses are defined.

Error	Float value display	Display
First error value	1.0E+37	
Software – underrange	1.0E+37	<<<<<<
Software – overrange	2.0E+37	>>>>>>
No valid input value	3.0E+37	-----
Division by zero	4.0E+37	-----
Incorrect mathematical value	5.0E+37	-----
Display capacity exceeded		*****
Invalid value		-----

In the event of an error, the device function reports this error itself in its output value. All device functions monitor an input value for these error values. In the event of an error, the output value is applied in turn to one of these error values, or another value is specified in the configuration (error value/substitute value).

16.2 Display of error messages for binary values

Binary input values are only displayed with 0 and 1. If no valid input value is available, or the device function cannot deliver a valid output value, the value is set to 0.

Exception

In the configuration level you can set which value the output should accept in the event of an error (error value/substitute value) and this value is then faded in.

Start/end display:

The graphic display elements of the display range are established for this (lower and upper limit in a bar graph display). The numeric representation is dependent on the display start/end and is produced from the entire measuring range. In the recording, measured values smaller than the display start are saved as UNDERRANGE and measured values larger than the display end are saved as OVERRANGE.

Bar graph display:

The numeric representation is dependent on the display start/end and is produced from the entire measuring range. In the recording, measured values smaller than the display start are saved as UNDERRANGE and measured values larger than the display end are saved as OVERRANGE.

Over- and underrange:

Detection is performed at hardware limits and on the scaling in mV. The maximum number of display ranges are therefore always available. For all the values calculated in the device such as mathematics output, flow rate, and external inputs, the following applies: The display range has the same significance here as for hardware inputs.

16 Error and alarm messages

17 Retrofitting optional boards

17.1 Safety information

You can upgrade or retrofit the device flexibly using the following description. All the necessary settings are described in the operating manual. Manipulations not described in the manual or expressly forbidden will jeopardize your warranty rights.



CAUTION!

Risk of damage to the modules by electrostatic discharge can occur. For this reason, avoid electrostatic charge during fitting and removal. Work in an "earthed" working area with the corresponding upgrade!



DANGER!

Do not touch live parts inside the device as they are highly charged. Disconnect (all poles) the device from the voltage supply before retrofitting. Only qualified personnel are permitted to carry out module retrofits. The country-specific requirements available regarding changes to an electrical device must be observed.

17.2 Identifying the modules

1	Identify the module from the part number on the sticker attached to the packaging
2	Check which slot the optional board may be inserted into. ⇒ Chapter 4.3 "Connection diagram", page 27
3	Only install modules in the device that are permitted for this optional slot.

Block diagram

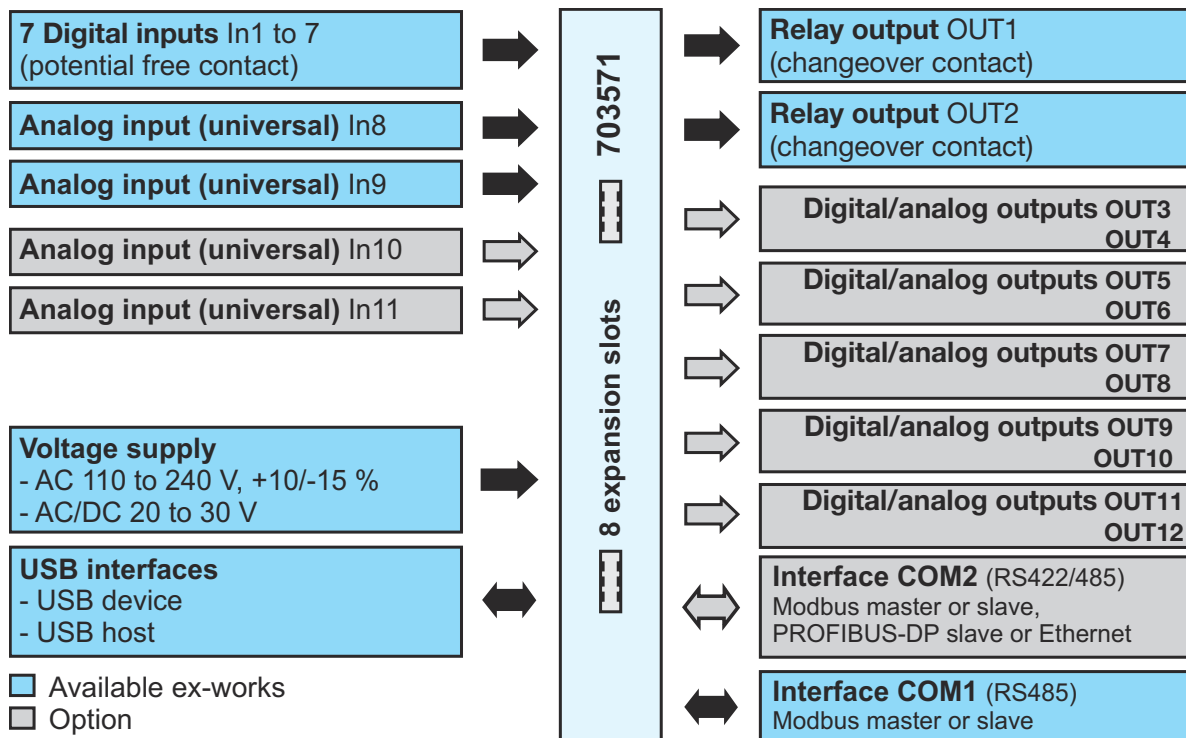

17 Retrofitting optional boards

17.3 Installing modules

In this example, a universal analog input is inserted in slot In10.

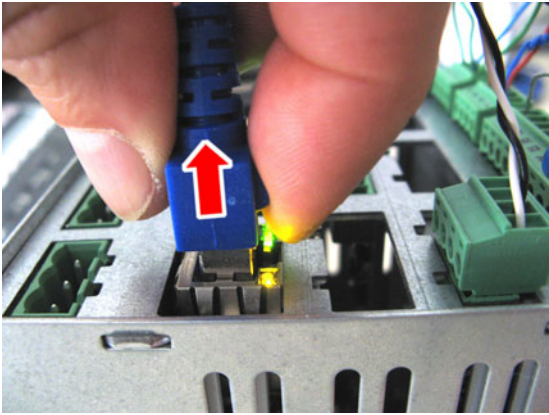
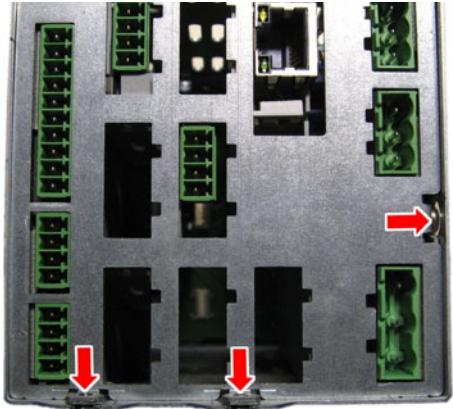
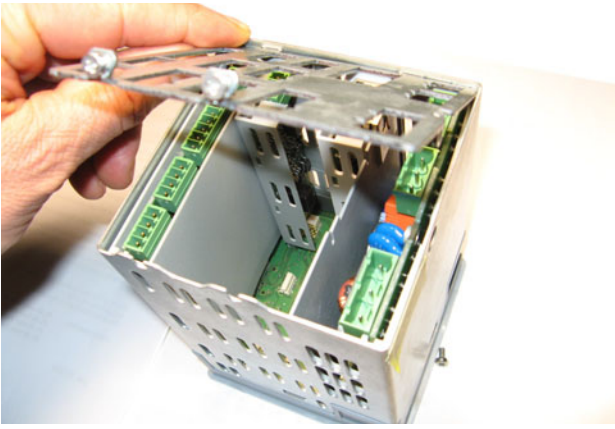
Step	Activity
1	Disconnect screw terminals and interface cables connected at the rear 
2	Loosen two screws at bottom (do not remove), remove side screw completely 
3	Lift up back panel and pull out 



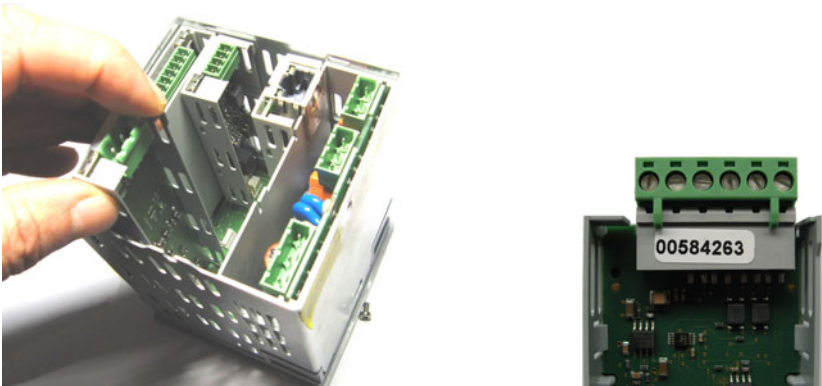
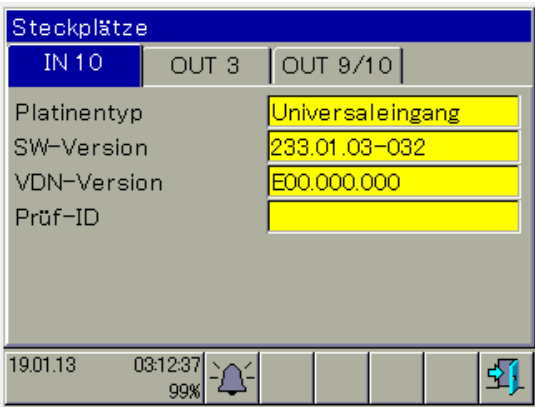
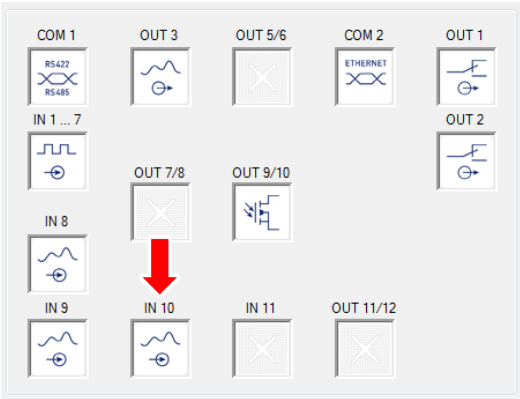



17 Retrofitting optional boards

Step	Activity
4	<p>Slide optional board into the slot provided. The parts no. is located on the screw terminal.</p> 
5	<p>Re-tighten the two screws with the associated toothed lock washers and screw in the side screw again, to ensure a guiding connection between the back panel and the side panel (secure grounding).</p>
6	<p>Switch on the device again and check whether the new hardware is recognized The new slot should appear in the device as follows: DEVICE INFO -> SLOTS</p>  <p>IT IS RECOGNIZED IN THE SETUP PROGRAM BY THE HARDWARE ASSISTANT: CURRENT HARDWARE -> HARDWARE ASSISTANT</p> 

➔ Result: The correctly recognized slot can now be configured and connected.

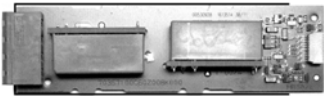
17 Retrofitting optional boards

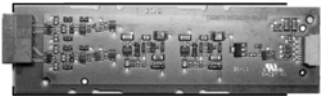
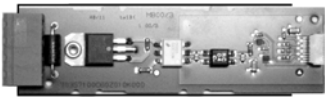
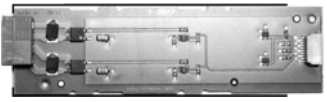
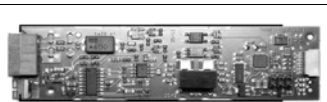
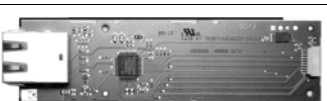
17.3.1 Accessories

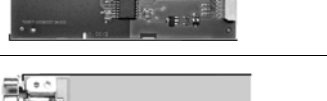
Article		Part no.
Modules for expansion slots:		
1 analog input (universal)		00581159
1 relay output (changeover contact)		00581160
2 relay outputs (N/O contact)		00581162
1 logic output DC 0/22 V max. 30 mA		00581165
2 logic outputs DC 0/12 V max. 20 mA		00581168
1 solid state relay AC 230 V, 1 A		00581164
2 PhotoMOS® relays ¹ DC 50 V, max. 200 mA, AC 35 V, max. 200 mA		00581171
1 analog output (universal)		00581169
Ethernet interface		00581174
Serial interface RS422/RS485		00581172
PROFIBUS-DP interface		00581173

¹ PhotoMOS is a registered trademark of Panasonic Corporation



JUMO GmbH & Co. KG

Street address:

Moritz-Juchheim-Straße 1
36039 Fulda, Germany

Delivery address:

Mackenrodtstraße 14
36039 Fulda, Germany

Postal address:

36035 Fulda, Germany

Phone: +49 661 6003-0

Fax: +49 661 6003-607

E-mail: mail@jumo.net

Internet: www.jumo.net

JUMO Instrument Co. Ltd.

JUMO House

Temple Bank, Riverway

Harlow - Essex CM20 2DY, UK

Phone: +44 1279 63 55 33

Fax: +44 1279 63 52 62

E-mail: sales@jumo.co.uk

Internet: www.jumo.co.uk

JUMO Process Control, Inc.

6733 Myers Road

East Syracuse, NY 13057, USA

Phone: 315-437-5866

1-800-554-5866

Fax: 315-437-5860

E-mail: info.us@jumo.net

Internet: www.jumousa.com