



## PNOZ m1p (ETH)

**PILZ**  
THE SPIRIT OF SAFETY

- ▶ Configurable safety systems PNOZmulti

This document is a translation of the original document.

All rights to this documentation are reserved by Pilz GmbH & Co. KG. Copies may be made for internal purposes. Suggestions and comments for improving this documentation will be gratefully received.

Pilz®, PIT®, PMI®, PNOZ®, Primo®, PSEN®, PSS®, PVIS®, SafetyBUS p®, SafetyEYE®, SafetyNET p®, the spirit of safety® are registered and protected trademarks of Pilz GmbH & Co. KG in some countries.

 SD means Secure Digital

<b>Section 1</b>	<b>Introduction</b>	<b>5</b>
	1.1 Validity of documentation	5
	1.2 Using the documentation	5
	1.3 Definition of symbols	5
<b>Section 2</b>	<b>Overview</b>	<b>7</b>
	2.1 Range	7
	2.2 Unit features	7
	2.3 Chip card	8
	2.4 Front view	9
<b>Section 3</b>	<b>Safety</b>	<b>11</b>
	3.1 Intended use	11
	3.2 System requirements	11
	3.3 Safety regulations	11
	3.3.1 Safety assessment	11
	3.3.2 Use of qualified personnel	12
	3.3.3 Warranty and liability	12
	3.3.4 Disposal	12
	3.3.5 For your safety	12
<b>Section 4</b>	<b>Function description</b>	<b>13</b>
	4.1 Integrated protection mechanisms	13
	4.2 Functions	13
	4.3 Block diagram	13
	4.4 Diagnostics	14
	4.5 Cascading	14
	4.6 Safety mat, muting	14
	4.7 Interfaces	14
<b>Section 5</b>	<b>Installation</b>	<b>15</b>
	5.1 Control cabinet installation	15
	5.2 Dimensions	16
	5.3 Install base unit without expansion module	16
	5.4 Connecting the base unit and expansion modules	17
<b>Section 6</b>	<b>Commissioning</b>	<b>18</b>
	6.1 General wiring guidelines	18
	6.2 Ethernet interfaces (ETH version only)	19
	6.2.1 RJ45 interfaces ("Ethernet")	19
	6.2.2 Requirements of the connection cable and connector	19
	6.2.3 Interface configuration	19
	6.2.4 RJ45 connection cable	20
	6.2.5 Process data exchange	21
	6.3 Function test during commissioning	21
	6.4 Commissioning the PNOZmulti control system for the first time	22
	6.4.1 Load project from chip card	22

---

6.4.2	Load project via integrated interface	22
6.5	Download modified project to the PNOZmulti system	23
6.5.1	Load modified project from chip card	23
6.5.2	Load modified project via integrated interface	23
6.6	Connection	23
6.7	Connection example	26
<b>Section 7</b>	<b>Operation</b>	<b>27</b>
7.1	LED indicators	27
7.1.1	Indicators for the Ethernet connection (ETH version only)	28
7.2	Reset Ethernet connection settings	28
<b>Section 8</b>	<b>Technical Details</b>	<b>29</b>
8.1	Safety characteristic data	36
<b>Section 9</b>	<b>Supplementary data</b>	<b>38</b>
9.1	Service life graph for the relay contacts	38
<b>Section 10</b>	<b>Order reference</b>	<b>40</b>
10.1	Product	40
10.2	Accessories	40

# 1 Introduction

## 1.1 Validity of documentation

This documentation is valid for the product PNOZ m1p. It is valid until new documentation is published.

This operating manual explains the function and operation, describes the installation and provides guidelines on how to connect the product.

## 1.2 Using the documentation

This document is intended for instruction. Only install and commission the product if you have read and understood this document. The document should be retained for future reference.

## 1.3 Definition of symbols

Information that is particularly important is identified as follows:



### **DANGER!**

This warning must be heeded! It warns of a hazardous situation that poses an immediate threat of serious injury and death and indicates preventive measures that can be taken.



### **WARNING!**

This warning must be heeded! It warns of a hazardous situation that could lead to serious injury and death and indicates preventive measures that can be taken.



### **CAUTION!**

This refers to a hazard that can lead to a less serious or minor injury plus material damage, and also provides information on preventive measures that can be taken.



### **NOTICE**

This describes a situation in which the product or devices could be damaged and also provides information on preventive measures that can be taken. It also highlights areas within the text that are of particular importance.

**INFORMATION**

This gives advice on applications and provides information on special features.

## 2 Overview

### 2.1 Range

- ▶ Base unit PNOZ m1p
- ▶ Terminator
- ▶ Documentation on data medium

### 2.2 Unit features

Using the product PNOZ m1p:

Base unit from the configurable control system PNOZmulti

The product has the following features:

- ▶ Can be configured in the PNOZmulti Configurator
- ▶ Positive-guided relay outputs:
  - 2 safety outputs  
Depending on the application, up to PL e of EN ISO 13849-1 and up to SIL CL 3 of EN IEC 62061
- ▶ Semiconductor outputs:
  - 4 safety outputs  
Depending on the application, up to PL e of EN ISO 13849-1 and up to SIL CL 3 of EN IEC 62061
  - 1 output for standard applications
- ▶ 4 test pulse outputs
- ▶ 1 cascading input and output;  
can also be used as a standard output
- ▶ 20 inputs for connecting, for example:
  - E-STOP pushbuttons
  - Two-hand pushbuttons
  - Safety gate limit switches
  - Start buttons
  - Light beam devices
  - Scanners
  - Enabling switches
  - PSEN
  - Operating mode selector switches
  - Safety mats
- ▶ Muting function
- ▶ LED indicator for:
  - Diagnostics
  - Supply voltage

- Output circuits
- Input circuits
- ▶ Test pulse outputs used to monitor shorts across the inputs
- ▶ Monitoring of shorts between the safety outputs
- ▶ Expansion modules can be connected  
(please refer to the document "PNOZmulti System Expansion" for details of the type and number that can be connected)
- ▶ Integrated interfaces:
  - PNOZ m1p: Serial interface RS232
  - PNOZ m1p **ETH**: 2 Ethernet interfaces
- ▶ Plug-in connection terminals:  
either spring-loaded terminal or screw terminal available as an accessory (see order reference)
- ▶ Coated version:  
Increased environmental requirements (see [Technical details](#)  29)

## 2.3 Chip card

To be able to use the product you will need a chip card.

Chip cards are available with memories of 8 kByte and 32 kByte. For large-scale projects we recommend the 32 kByte chip card (see Technical Catalogue: Accessories chapter).



## 2.4 Front view

### PNOZ m1p

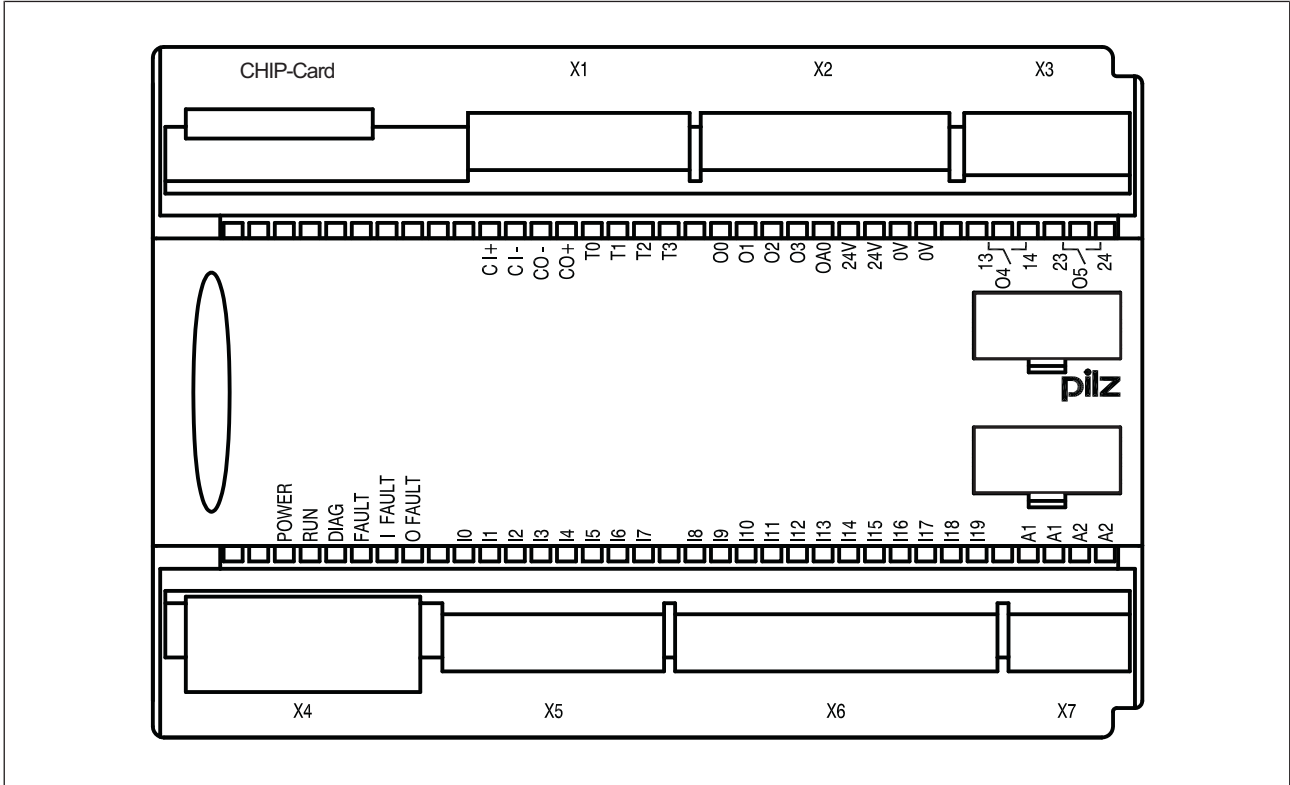

### PNOZ m1p ETH

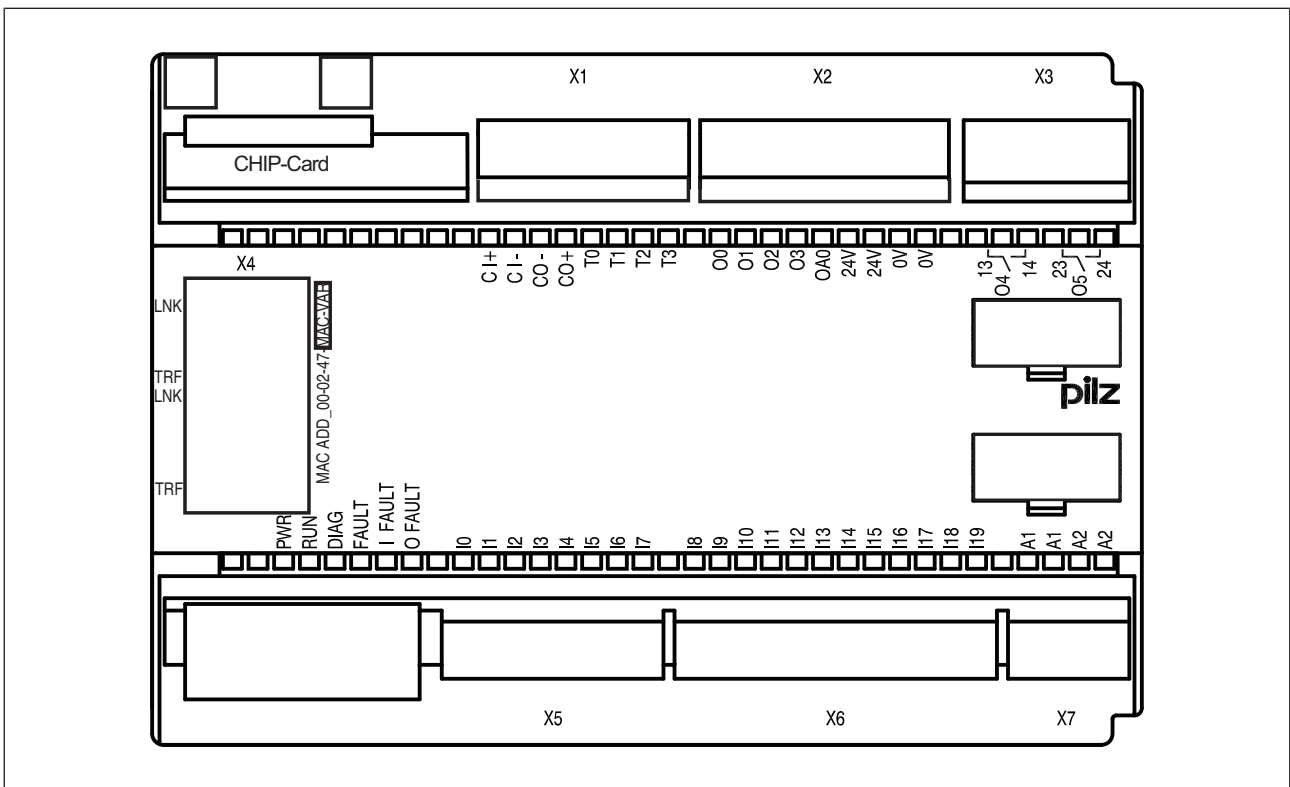

**Legend:**

CHIP card	Chipkarte interface
X1	Cascading inputs and outputs CI and CO, Test pulse outputs T0 ... T3
X2	Semiconductor outputs O0 ... O3, Auxiliary output OA0, Supply connections
X3	Relay outputs O4 and O5
X4	RS232 interface / Ethernet interface
X5, X6	Inputs I0 ... I19
X7	Power supply
LEDs:	PWR RUN DIAG FAULT I FAULT O FAULT

## 3 Safety

### 3.1 Intended use

The configurable small control systems PNOZmulti are used for the safety-related interruption of safety circuits and are designed for use in:

- ▶ E-STOP equipment
- ▶ Safety circuits in accordance with VDE 0113 Part 1 and EN 60204-1



#### CAUTION!

Inputs and outputs for standard functions must not be used for safety-related applications.

The coated version of the product PNOZ m1p is suitable for use where there are increased environmental requirements (see [Technical details](#) [ 29]).

The following is deemed improper use in particular:

- ▶ Any component, technical or electrical modification to the product
- ▶ Use of the product outside the areas described in this manual
- ▶ Use of the product outside the technical details (see [Technical details](#) [ 29]).



#### NOTICE

EMC-compliant electrical installation

The product is designed for use in an industrial environment. The product may cause interference if installed in other environments. If installed in other environments, measures should be taken to comply with the applicable standards and directives for the respective installation site with regard to interference.

### 3.2 System requirements

Please refer to the "Product Modifications" document in the "Version overview" section for details of which versions of the PNOZmulti Configurator can be used for this product.

### 3.3 Safety regulations

#### 3.3.1 Safety assessment

Before using a unit it is necessary to perform a safety assessment in accordance with the Machinery Directive.

Functional safety is guaranteed for the product as a single component. However, this does not guarantee the functional safety of the overall plant/machine. In order to achieve the required safety level for the overall plant/machine, define the safety requirements for the plant/machine and then define how these must be implemented from a technical and organisational standpoint.

### 3.3.2 Use of qualified personnel

The products may only be assembled, installed, programmed, commissioned, operated, maintained and decommissioned by competent persons.

A competent person is someone who, because of their training, experience and current professional activity, has the specialist knowledge required to test, assess and operate the work equipment, devices, systems, plant and machinery in accordance with the general standards and guidelines for safety technology.

It is the company's responsibility only to employ personnel who:

- ▶ Are familiar with the basic regulations concerning health and safety / accident prevention
- ▶ Have read and understood the information provided in this description under "Safety"
- ▶ And have a good knowledge of the generic and specialist standards applicable to the specific application.

### 3.3.3 Warranty and liability

All claims to warranty and liability will be rendered invalid if

- ▶ The product was used contrary to the purpose for which it is intended
- ▶ Damage can be attributed to not having followed the guidelines in the manual
- ▶ Operating personnel are not suitably qualified
- ▶ Any type of modification has been made (e.g. exchanging components on the PCB boards, soldering work etc.).

### 3.3.4 Disposal

- ▶ In safety-related applications, please comply with the mission time  $T_M$  in the safety-related characteristic data.
- ▶ When decommissioning, please comply with local regulations regarding the disposal of electronic devices (e.g. Electrical and Electronic Equipment Act).

### 3.3.5 For your safety

The device meets all the necessary conditions for safe operation. However, you should always ensure that the following safety requirements are met:

- ▶ This operating manual only describes the basic functions of the device. Advanced functions are described in the online help for the PNOZmulti Configurator, in the "PNOZmulti Communication Interfaces" document and in "PNOZmulti Special Applications". Only use these functions once you have read and understood the documentation.
- ▶ You must note the information stated in the PNOZmulti Safety Manual.
- ▶ Adequate protection must be provided for all inductive consumers.
- ▶ Do not open the housing or make any unauthorised modifications.
- ▶ Please make sure you shut down the supply voltage when performing maintenance work (e.g. exchanging contactors).

## 4 Function description

### 4.1 Integrated protection mechanisms

The relay conforms to the following safety criteria:

- ▶ The circuit is redundant with built-in self-monitoring.
- ▶ The safety function remains effective in the case of a component failure.
- ▶ The relay contacts meet the requirements for protective separation through increased insulation compared with all other circuits in the safety system.
- ▶ The safety outputs are tested periodically using a disconnection test.

### 4.2 Functions

The function of the inputs and outputs on the control system depends on the safety circuit created using the PNOZmulti Configurator. A chip card is used to download the safety circuit to the base unit. The base unit has 2 microcontrollers that monitor each other. They evaluate the input circuits on the base unit and expansion modules and switch the outputs on the base unit and expansion modules accordingly.

The LEDs on the base unit and expansion modules indicate the status of the configurable control system PNOZmulti.

The online help on the PNOZmulti Configurator contains descriptions of the operating modes and all the functions of the control system, plus connection examples.

### 4.3 Block diagram

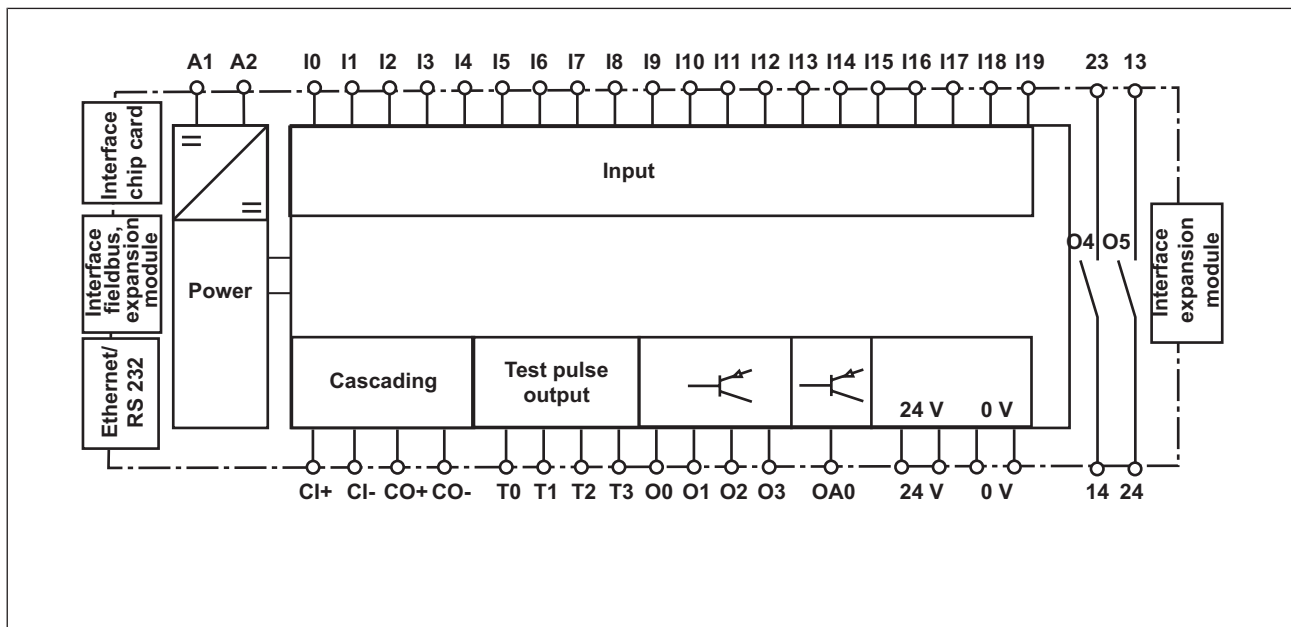

## 4.4 Diagnostics

The status and error messages displayed by the LEDs are saved in an error stack. This error stack can be read from the PNOZmulti Configurator via the interfaces (RS 232 or Ethernet). More comprehensive diagnostics are possible via the interfaces or one of the fieldbus modules, e.g. the PROFIBUS module.

## 4.5 Cascading

The cascading inputs and outputs enable several PNOZmulti and PNOZelog units to be connected in series or as a tree structure.



### INFORMATION

Detailed information on these functions and connection examples can be found in the online help for the PNOZmulti Configurator and in the PNOZmulti Installation Manual.

## 4.6 Safety mat, muting



### INFORMATION

Detailed information on these functions and connection examples can be found in the online help for the PNOZmulti Configurator and in the document entitled "PNOZmulti - Special Applications".

## 4.7 Interfaces

The product PNOZ m1p **ETH** has two Ethernet interfaces, the product PNOZ m1p has one serial interface to

- ▶ Project download
- ▶ Read the diagnostic data
- ▶ Set virtual inputs for standard functions
- ▶ Read virtual outputs for standard functions.

Information on diagnostics via the interfaces can be found in the document "PNOZmulti communication interfaces".

The connection to Ethernet is made via the two 8-pin RJ45 sockets.

The Ethernet interface is configured in the PNOZmulti Configurator and is described in the online help for the PNOZmulti Configurator.

## 5 Installation

### 5.1 Control cabinet installation

- ▶ The control system should be installed in a control cabinet with a protection type of at least IP54. Fit the control system to a horizontal mounting rail. The venting slots must face upward and downward. Other mounting positions could destroy the control system.
- ▶ Use the notches on the rear of the unit to attach it to a mounting rail. Connect the control system to the mounting rail in an upright position, so that the earthing springs on the control system are pressed on to the mounting rail.
- ▶ The ambient temperature of the PNOZmulti units in the control cabinet must not exceed the figure stated in the technical details, otherwise air conditioning will be required.
- ▶ To comply with EMC requirements, the mounting rail must have a low impedance connection to the control cabinet housing.

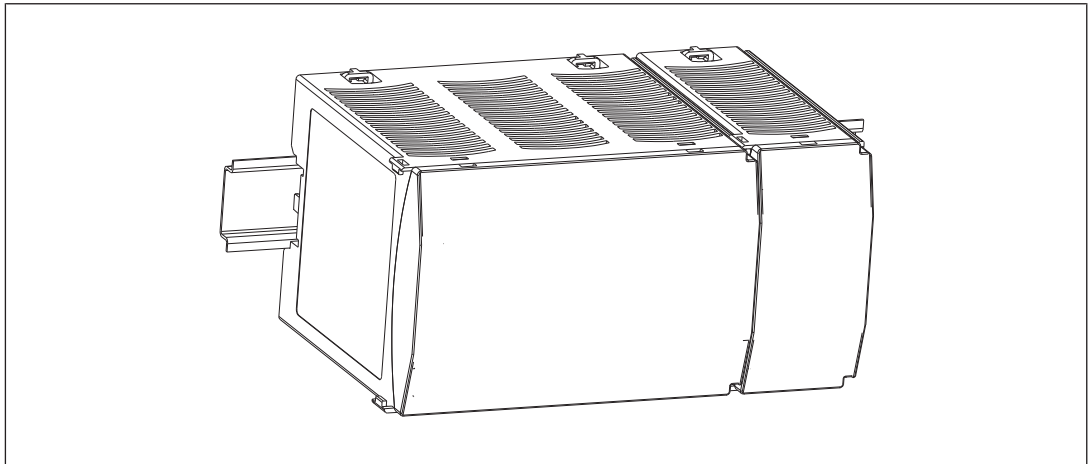

#### NOTICE

Damage due to electrostatic discharge!

Electrostatic discharge can damage components. Ensure against discharge before touching the product, e.g. by touching an earthed, conductive surface or by wearing an earthed armband.

## 5.2 Dimensions

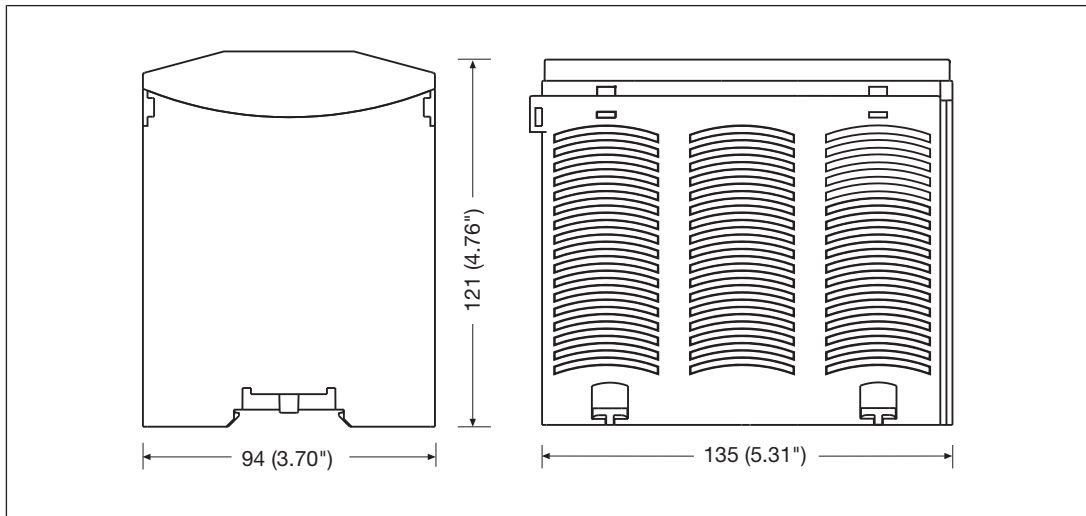

## 5.3 Install base unit without expansion module

- ▶ The terminator must be fitted to the side of the base unit marked "Termination/Link".
- ▶ Do not fit a terminator on the left hand side of the base unit.

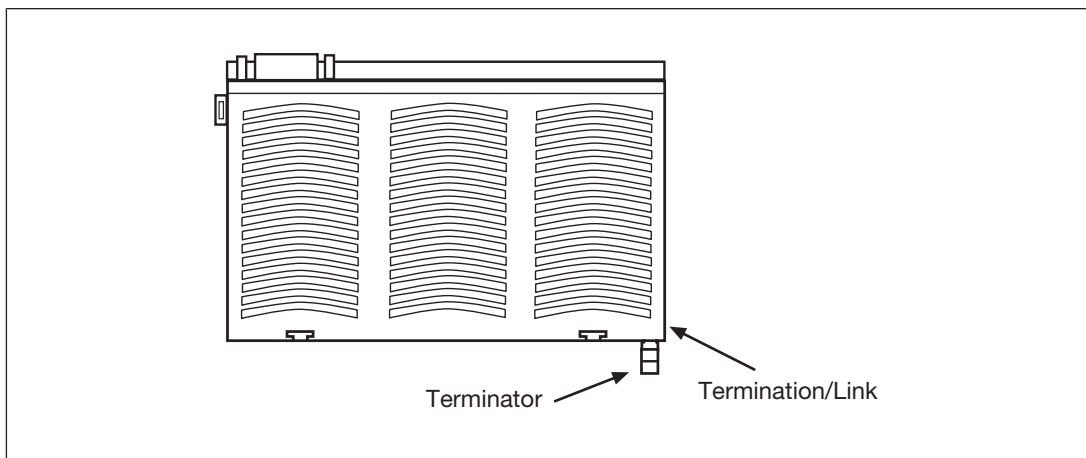



## 5.4 Connecting the base unit and expansion modules

The position of the expansion modules is defined in the PNOZmulti Configurator. The expansion modules are connected to the left or right of the base unit, depending on the type.

Please refer to the document "PNOZmulti System Expansion" for details of the number of modules that can be connected to the base unit and the module types.

The modules are linked via jumpers.

There are 2 pin connectors on the rear of the base unit.

A max. of 12 expansion modules plus one fieldbus module may be connected to one base unit.

- ▶ Ensure that no terminator is connected.
- ▶ Connect the base unit, the expansion modules and the fieldbus module using the jumpers supplied.
- ▶ The terminator must be fitted to the last expansion module to the right of the base unit.
- ▶ A terminator must not be fitted to the last expansion module to the left of the base unit.

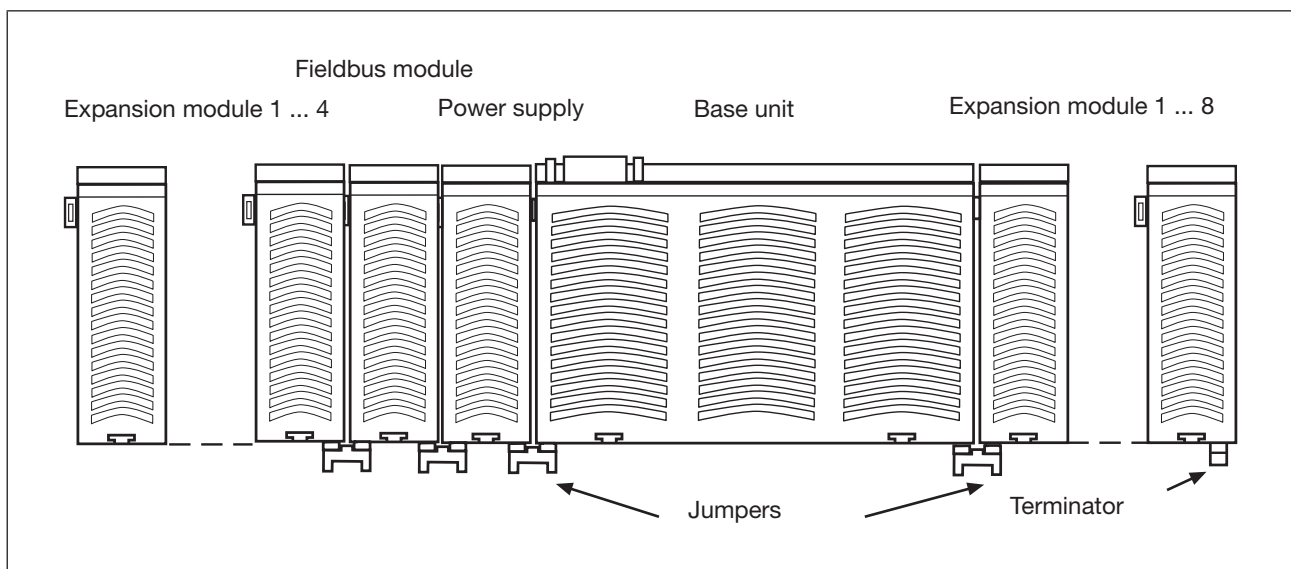

## 6 Commissioning

### 6.1 General wiring guidelines

The wiring is defined in the circuit diagram in the Configurator. There you can select the inputs that are to perform a safety function and the outputs that are to switch this safety function.

Please note:



#### CAUTION!

The plug-in connection terminals on the relay outputs carry mains voltage and should only be connected and disconnected when the voltage is switched off.

- ▶ Information given in the [Technical details \[29\]](#) must be followed.
- ▶ Outputs:
  - O0 to O5 are safety outputs
  - O4 and O5 are relay outputs
  - O0 to O3 are semiconductor outputs
  - OA0 is an output to delete a project from the base unit (see online help for the PNOZmutli Configurator).
- ▶ To prevent contact welding, a fuse should be connected before the output contacts (see technical details).
- ▶ Use copper wiring with a temperature stability of 75°C.
- ▶ Sufficient fuse protection must be provided on all output contacts with inductive loads.
- ▶ The control system and input circuits must always be supplied by a single power supply. The power supply must meet the regulations for extra low voltages with protective separation.
- ▶ Two connection terminals are available for each of the supply connections 24 V and 0 V (semiconductor outputs), plus A1 and A2 (power supply). This means that the supply voltage can be looped through several connections. When the supply voltage is looped, the current at each terminal may not exceed 3 A.
- ▶ Test pulse outputs must exclusively be used to test the inputs. They must not be used to drive loads.  
Do not route the test pulse lines together with actuator cables within an unprotected multicore cable.
- ▶ Test pulse outputs are also used to supply safety mats that trigger a short circuit.  
Test pulses that are used for the safety mat may not be reused for other purposes.

## 6.2 Ethernet interfaces (ETH version only)

### 6.2.1 RJ45 interfaces ("Ethernet")

Two free switch ports are provided as Ethernet interfaces via an internal autosensing switch. The autosensing switch automatically detects whether data transfer is occurring at 10 Mbit/s or 100 Mbit/s.



#### INFORMATION

The connected subscribers must support the autosensing/autonegotiation function. If not, the communication partner must be set permanently to "10 Mbit/s, half duplex".

The switch's automatic crossover function means there is no need to distinguish on the connection cable between patch cable (uncrossed data line connection) and crossover cable (crossover data line connection). The switch automatically creates the correct data line connection internally. Patch cable can therefore be used as the connection cable for end devices as well as cascading.

Both Ethernet interfaces use RJ45 technology.

### 6.2.2 Requirements of the connection cable and connector

The following minimum requirements must be met:

- ▶ Ethernet standards (min. Category 5) 10BaseT or 100BaseTX
- ▶ Double-shielded twisted pair cable for industrial Ethernet use
- ▶ Shielded RJ45 connectors (industrial connectors)

### 6.2.3 Interface configuration

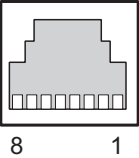
RJ45 socket 8-pin	PIN	Standard	Crossover
	1	TD+ (Transmit+)	RD+ (Receive+)
	2	TD- (Transmit-)	RD- (Receive-)
	3	RD+ (Receive+)	TD+ (Transmit+)
	4	n.c.	n.c.
	5	n.c.	n.c.
	6	RD- (Receive-)	TD- (Transmit-)
	7	n.c.	n.c.
	8	n.c.	n.c.

## 6.2.4 RJ45 connection cable

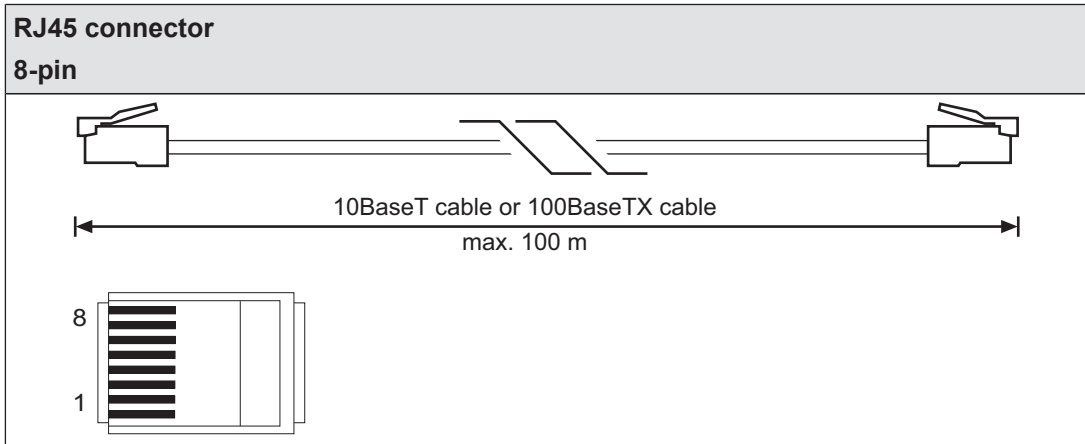

### NOTICE

With the plug-in connection please note that the data cable and connector have a limited mechanical load capacity. Appropriate design measures should be used to ensure that the plug-in connection is insensitive to increased mechanical stress (e.g. through shock, vibration). Such measures include fixed routing with strain relief, for example.

### 6.2.5 Process data exchange

The RJ45 interfaces on the internal autosensing switch enable process data to be exchanged with other Ethernet subscribers within a network.

The product PNOZ m1p **ETH** can also be connected to Ethernet via a hub (hub or switch).

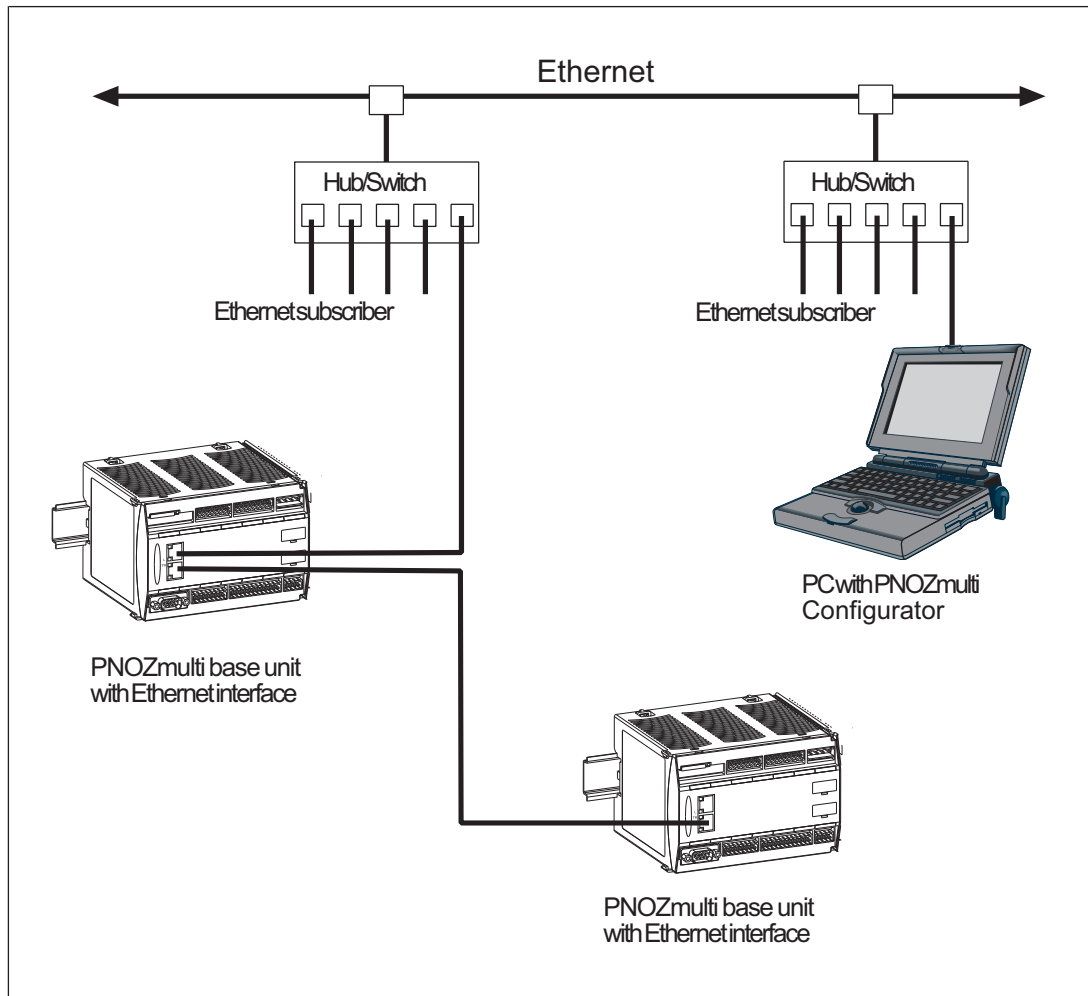

Fig.: PNOZmulti as Ethernet subscriber - possible topologies

## 6.3 Function test during commissioning



### CAUTION!

It is essential to check that the safety devices operate correctly

- after the chip card has been exchanged
- after a project has been downloaded
- when the project has been deleted from the base unit's memory ("Reset Project" menu)

## 6.4 Commissioning the PNOZmulti control system for the first time

Procedure:

- ▶ Wire the inputs and outputs on the base unit and expansion modules in accordance with the circuit diagram.
- ▶ Cascading output as auxiliary output: Connect the load to CO+ and A2, see connection example.
- ▶ Connect the supply voltage:
  - Supply voltage for the units (connector X7):
  - Terminal A1: + 24 VDC
  - Terminal A2: 0 V
  - Supply voltage for the semiconductor outputs (connector X2):
  - 24 V terminal: + 24 VDC
  - 0V terminal: 0 V

Please note: Supply voltage must always be applied to X2 and X7, even if you are not using the semiconductor outputs.

### 6.4.1 Load project from chip card



#### NOTICE

Chip contacting is only guaranteed if the contact surface is clean and undamaged. The chip's contact surface should therefore be protected from contamination, contact and mechanical impact such as scratches.

Procedure:

- ▶ Insert the chip card containing the current project into the card slot on the base unit.
- ▶ Switch on the supply voltage.

### 6.4.2 Load project via integrated interface

Procedure:

- ▶ Insert a chip card into the chip card slot on the base unit.
- ▶ Connect the computer containing the PNOZmulti Configurator to the base unit via the interface.
- ▶ Switch on the supply voltage.
- ▶ Download the project (see PNOZmulti Configurator's online help).



#### INFORMATION

You will need a PC with an Ethernet card in order to establish an Ethernet connection.

## 6.5 Download modified project to the PNOZmulti system

### 6.5.1 Load modified project from chip card

To download data via chip card, the existing configuration data must first be deleted (general reset of device).

Procedure:

- ▶ Switch off the supply voltage.
- ▶ Disconnect all the output terminals.
- ▶ Jumper OA0-I19 on the base unit.
- ▶ Switch on the supply voltage.

When the "DIAG" LED on the base unit flashes, the memory has been cleared. The project data can now be downloaded:

- ▶ Switch off the supply voltage.
- ▶ Remove the old chip card from the chip card slot on the base unit.
- ▶ Remove the jumper from OA0-I19 on the base unit.
- ▶ Insert the chip card containing the current project into the card slot.
- ▶ Switch on the supply voltage.

### 6.5.2 Load modified project via integrated interface

Proceed as described for the initial commissioning

## 6.6 Connection

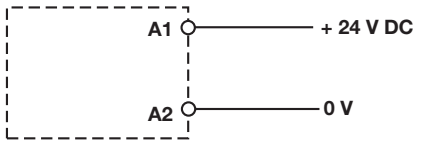
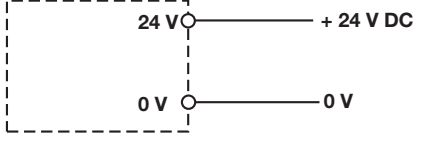
Supply voltage	AC	DC
For the safety system (connector X7)	/	
For the semiconductor outputs (connector X2) Must always be present, even if the semiconductor outputs are not used	/	

Supply voltage

Input circuit	Single-channel	Dual-channel
E-STOP <b>without</b> detection of shorts across contacts		
E-STOP <b>with</b> detection of shorts across contacts		

Connection examples for the input circuit

Start circuit	Input circuit without detection of shorts across contacts	Input circuit with detection of shorts across contacts

Connection examples for start circuit

Redundant output		
Single output		

Connection examples for semiconductor outputs



<p>Redundant output</p>		
<p>Single output</p>		

Connection examples for relay outputs

<p>Feedback loop</p>	<p>Redundant output</p>	
<p>Contacts from external contactors</p>		

Connection examples for feedback loop

## 6.7 Connection example

Dual-channel E-STOP and safety gate wiring, monitored start (I17), feedback loop (I14), cascading output as auxiliary output (CO+/A2)

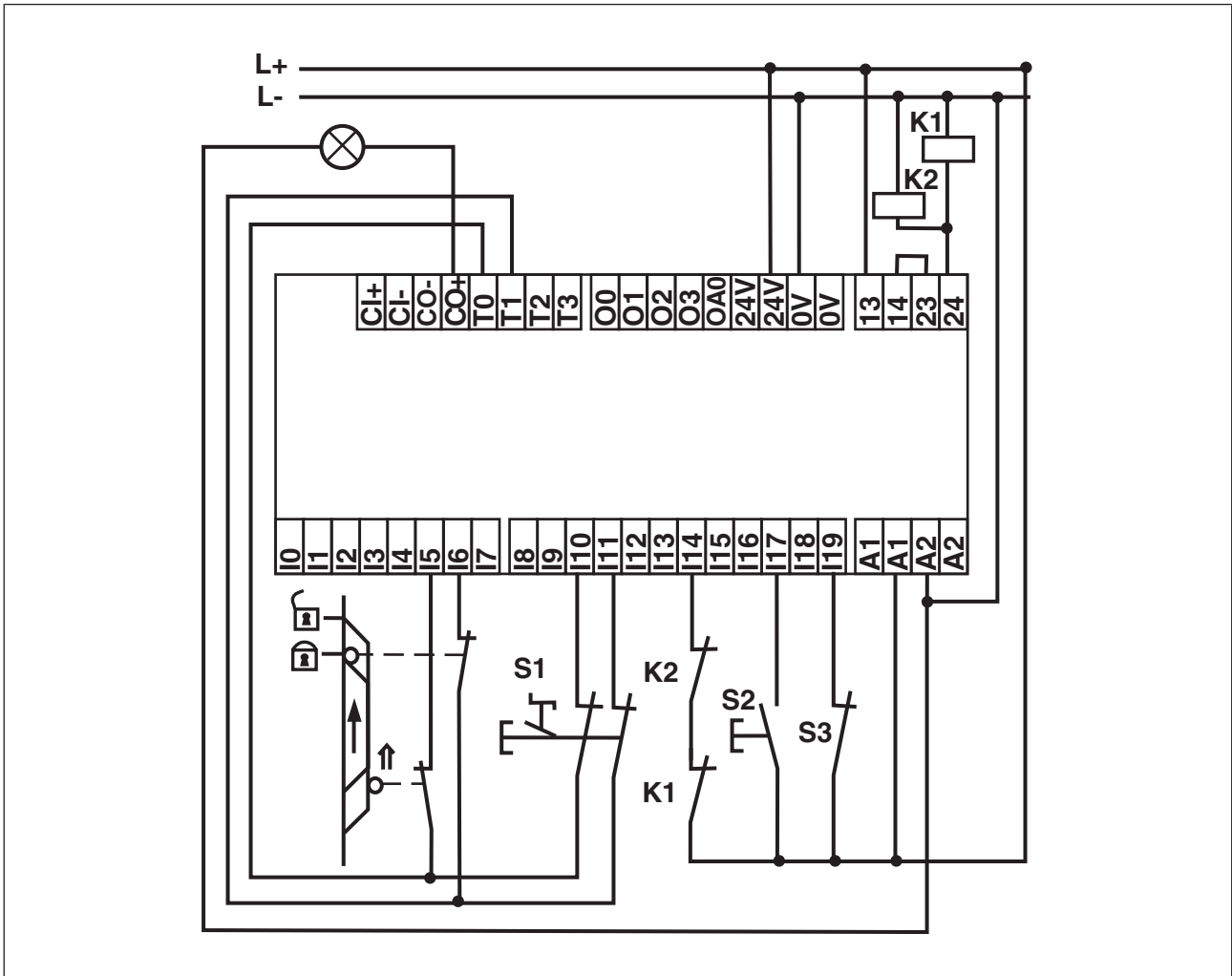

## 7 Operation



When the supply voltage is switched on, the PNOZmulti safety system copies the configuration from the chip card.





















The LEDs "POWER", "DIAG", "FAULT", "IFAULT" and "OFAULT" will light up on the base unit.

The PNOZmulti control system is ready for operation when the "POWER" and "RUN" LEDs on the base unit are lit continuously.

### 7.1 LED indicators

**Legend**

-  LED on
-  LED flashes
-  LED off

Basis								Exp.		Error
Input Ix	RUN	DIAG	FAULT	IFAULT	OFAULT	CI	CO	FAULT	IN/OUT	
	●									The existing user program has been deleted.
	●									External error on the base unit, leading to a safe condition, e.g. terminator not connected
	●									External error leading to a safe condition, e.g. short across the contacts or error at safety mat input.
	●									External error on the base unit outputs, e.g. short across the contacts, leading to a safe condition.
	●									External error, leading to a safe condition, e.g. short across the contacts
	●									External error on the output
	●									Internal error on the base unit
	●									Internal error on the base unit
	●									Internal error on the base unit
	●									Internal error on the expansion module
	●									Base unit in a STOP condition
										External error on the base unit inputs, which does not lead to a safe condition, e.g. partially operated
										External error on the base unit outputs, which does not lead to a safe condition, e.g. feedback input defective

Basis								Exp.		Error
Input Ix	RUN	DIAG	FAULT	IFAU	OFAU	CI	CO	FAULT	IN/OUT	
										External error on the inputs, which does not lead to a safe condition, e.g. partially operated; feedback input defective
										The fieldbus module has not been recognised. Or The base unit has been identified via the PNOZmulti Configurator.
										Error on cascading input; unit remains in a RUN condition
										Error on cascading output; unit remains in a RUN condition

### 7.1.1 Indicators for the Ethernet connection (ETH version only)

The operating and fault states of the Ethernet connection are displayed via the LNK (Link) and TRF (Traffic) LEDs on the Ethernet interfaces.

LED	Signal	Meaning
LNK (green)		No network connection
		Network connection present
TRF (yellow)		No data traffic
		Data traffic present

## 7.2 Reset Ethernet connection settings

The Ethernet connection settings of the base unit can be configured in the PNOZmulti Configurator.

You can reset the base unit's Ethernet connection settings to the default settings.

Proceed as follows:

- ▶ Switch off the supply voltage
- ▶ Remove the chip card
- ▶ Restart the base unit without the chip card inserted.

The Ethernet connection settings are now reset to the default settings.

## 8 Technical Details

General	773100	773103	773104	773105
Approvals	BG, CCC, CE, EAC (Eurasian), KCC, KOSHA, TÜV, cULus Listed	BG, CCC, CE, EAC (Eurasian), KCC, TÜV, cULus Listed	BG, CCC, CE, EAC (Eurasian), TÜV, cULus Listed	BG, CCC, CE, EAC (Eurasian), KCC, KOSHA, TÜV, cULus Listed
Electrical data	773100	773103	773104	773105
Supply voltage for	Supply to the system	Supply to the system	Supply to the system	Supply to the system
Voltage	24,0 V	24,0 V	24,0 V	24,0 V
Kind	DC	DC	DC	DC
Voltage tolerance	-15 %/+20 %	-15 %/+20 %	-15 %/+20 %	-15 %/+20 %
Output of external power supply (DC) at no load	8,0 W	9,0 W	9,0 W	8,0 W
Residual ripple DC	5 %	5 %	5 %	5 %
Supply voltage for	Supply to the SC outputs	Supply to the SC outputs	Supply to the SC outputs	Supply to the SC outputs
Voltage	24 V	24 V	24 V	24 V
Kind	DC	DC	DC	DC
Voltage tolerance	-15 %/+20 %	-15 %/+20 %	-15 %/+20 %	-15 %/+20 %
Output of external power supply (DC)	192,0 W	192,0 W	192,0 W	192,0 W
Residual ripple DC	5 %	5 %	5 %	5 %
Potential isolation	yes	yes	yes	yes
Supply voltage				
Power consumption per expansion module	2,50 W	2,50 W	2,50 W	2,50 W
Status indicator	LED	LED	LED	LED
Inputs	773100	773103	773104	773105
Number	20	20	20	20
Max. number of live inputs within the max. permitted ambient temperature (see "Environmental data")	U <sub>B</sub> ≤ 26,4 V : 20, U <sub>B</sub> > 26,4 V : 15	U <sub>B</sub> ≤ 26,4 V : 20, U <sub>B</sub> > 26,4 V : 15	U <sub>B</sub> ≤ 26,4 V : 20, U <sub>B</sub> > 26,4 V : 15	U <sub>B</sub> ≤ 26,4 V : 20, U <sub>B</sub> > 26,4 V : 15
Signal level at "0"	-3 - +5 V DC	-3 - +5 V DC	-3 - +5 V DC	-3 - +5 V DC
Signal level at "1"	15 - 30 V DC	15 - 30 V DC	15 - 30 V DC	15 - 30 V DC
Input voltage in accordance with EN 61131-2 Type 1	24 V DC	24 V DC	24 V DC	24 V DC

<b>Inputs</b>	<b>773100</b>	<b>773103</b>	<b>773104</b>	<b>773105</b>
Input current at rated voltage	<b>8 mA</b>	<b>8 mA</b>	<b>8 mA</b>	<b>8 mA</b>
Min. pulse duration	<b>18 ms</b>	<b>18 ms</b>	<b>18 ms</b>	<b>18 ms</b>
Pulse suppression	<b>0,6 ms</b>	<b>0,6 ms</b>	<b>0,6 ms</b>	<b>0,6 ms</b>
Maximum input delay	<b>4 ms</b>	<b>4 ms</b>	<b>4 ms</b>	<b>4 ms</b>
Potential isolation	<b>No</b>	<b>No</b>	<b>No</b>	<b>No</b>
<b>Semiconductor outputs</b>	<b>773100</b>	<b>773103</b>	<b>773104</b>	<b>773105</b>
Number	<b>4</b>	<b>4</b>	<b>4</b>	<b>4</b>
Switching capability				
Voltage	<b>24 V</b>	<b>24 V</b>	<b>24 V</b>	<b>24 V</b>
Current	<b>2,0 A</b>	<b>2,0 A</b>	<b>2,0 A</b>	<b>2,0 A</b>
Power	<b>48 W</b>	<b>48 W</b>	<b>48 W</b>	<b>48 W</b>
Derating of coated version at an ambient temperature > 50 °C				
Voltage	–	–	<b>24 V</b>	<b>24 V</b>
Current	–	–	<b>1 A</b>	<b>1 A</b>
Power	–	–	<b>24 W</b>	<b>24 W</b>
Signal level at "1"	<b>UB - 0.5 VDC at 2 A</b>	<b>UB - 0.5 VDC at 2 A</b>	<b>UB - 0.5 VDC at 2 A</b>	<b>UB - 0.5 VDC at 2 A</b>
Residual current at "0"	<b>0,5 mA</b>	<b>0,5 mA</b>	<b>0,5 mA</b>	<b>0,5 mA</b>
Max. capacitive load	<b>1 µF</b>	<b>1 µF</b>	<b>1 µF</b>	<b>1 µF</b>
Max. duration of off time during self test	<b>300 µs</b>	<b>300 µs</b>	<b>300 µs</b>	<b>300 µs</b>
Switch-off delay	<b>30 ms</b>	<b>30 ms</b>	<b>30 ms</b>	<b>30 ms</b>
Potential isolation	<b>yes</b>	<b>yes</b>	<b>yes</b>	<b>yes</b>
Short circuit-proof	<b>yes</b>	<b>yes</b>	<b>yes</b>	<b>yes</b>
<b>Semiconductor outputs (standard)</b>	<b>773100</b>	<b>773103</b>	<b>773104</b>	<b>773105</b>
Number	<b>1</b>	<b>1</b>	<b>1</b>	<b>1</b>
Switching capability				
Voltage	<b>24 V</b>	<b>24 V</b>	<b>24 V</b>	<b>24 V</b>
Current	<b>0,50 A</b>	<b>0,50 A</b>	<b>0,50 A</b>	<b>0,50 A</b>
Power	<b>12,0 W</b>	<b>12,0 W</b>	<b>12,0 W</b>	<b>12,0 W</b>
Galvanic isolation	<b>yes</b>	<b>yes</b>	<b>yes</b>	<b>yes</b>
Short circuit-proof	<b>yes</b>	<b>yes</b>	<b>yes</b>	<b>yes</b>
Residual current at "0"	<b>0,5 mA</b>	<b>0,5 mA</b>	<b>0,5 mA</b>	<b>0,5 mA</b>
Signal level at "1"	<b>UB - 0.5 VDC at 0.5 A</b>	<b>UB - 0.5 VDC at 0.5 A</b>	<b>UB - 0.5 VDC at 0.5 A</b>	<b>UB - 0.5 VDC at 0.5 A</b>
<b>Test pulse outputs</b>	<b>773100</b>	<b>773103</b>	<b>773104</b>	<b>773105</b>
Number of test pulse outputs	<b>4</b>	<b>4</b>	<b>4</b>	<b>4</b>
Voltage	<b>24 V</b>	<b>24 V</b>	<b>24 V</b>	<b>24 V</b>

<b>Test pulse outputs</b>	<b>773100</b>	<b>773103</b>	<b>773104</b>	<b>773105</b>
Current	<b>0,5 A</b>	<b>0,5 A</b>	<b>0,5 A</b>	<b>0,5 A</b>
Max. duration of off time during self test	<b>5 ms</b>	<b>5 ms</b>	<b>5 ms</b>	<b>5 ms</b>
Short circuit-proof	<b>yes</b>	<b>yes</b>	<b>yes</b>	<b>yes</b>
Potential isolation	<b>No</b>	<b>No</b>	<b>No</b>	<b>No</b>
<b>Relay outputs</b>	<b>773100</b>	<b>773103</b>	<b>773104</b>	<b>773105</b>
Utilisation category				
In accordance with the standard	<b>EN 60947-4-1</b>	<b>EN 60947-4-1</b>	<b>EN 60947-4-1</b>	<b>EN 60947-4-1</b>
Utilisation category of safety contacts				
AC1 at	<b>240 V</b>	<b>240 V</b>	<b>240 V</b>	<b>240 V</b>
Max. current	<b>6,0 A</b>	<b>6,0 A</b>	<b>6,0 A</b>	<b>6,0 A</b>
Max. power	<b>1440 VA</b>	<b>1440 VA</b>	<b>1440 VA</b>	<b>1440 VA</b>
DC1 at	<b>24 V</b>	<b>24 V</b>	<b>24 V</b>	<b>24 V</b>
Max. current	<b>6,0 A</b>	<b>6,0 A</b>	<b>6,0 A</b>	<b>6,0 A</b>
Max. power	<b>144 W</b>	<b>144 W</b>	<b>144 W</b>	<b>144 W</b>
Derating of coated version at an ambient temperature > 50 °C				
Safety contacts, AC1 at	–	–	<b>240 V</b>	<b>240 V</b>
Max. current	–	–	<b>4 A</b>	<b>4 A</b>
Max. power	–	–	<b>960 W</b>	<b>960 W</b>
Safety contacts, DC 1 at	–	–	<b>24 V</b>	<b>24 V</b>
Max. current	–	–	<b>4 A</b>	<b>4 A</b>
Max. power	–	–	<b>96 W</b>	<b>96 W</b>
Utilisation category				
In accordance with the standard	<b>EN 60947-5-1</b>	<b>EN 60947-5-1</b>	<b>EN 60947-5-1</b>	<b>EN 60947-5-1</b>
Utilisation category of safety contacts				
AC15 at	<b>230 V</b>	<b>230 V</b>	<b>230 V</b>	<b>230 V</b>
Max. current	<b>3,0 A</b>	<b>3,0 A</b>	<b>3,0 A</b>	<b>3,0 A</b>
Max. power	<b>690 W</b>	<b>690 W</b>	<b>690 W</b>	<b>690 W</b>
DC13 (6 cycles/min) at	<b>24 V</b>	<b>24 V</b>	<b>24 V</b>	<b>24 V</b>
Max. current	<b>3,0 A</b>	<b>3,0 A</b>	<b>3,0 A</b>	<b>3,0 A</b>
Max. power	<b>72 W</b>	<b>72 W</b>	<b>72 W</b>	<b>72 W</b>
Airgap creepage between				
Relay contacts	<b>3 mm</b>	<b>3 mm</b>	<b>3 mm</b>	<b>3 mm</b>
Relay contacts and other circuits	<b>5,5 mm</b>	<b>5,5 mm</b>	<b>5,5 mm</b>	<b>5,5 mm</b>

<b>Relay outputs</b>	<b>773100</b>	<b>773103</b>	<b>773104</b>	<b>773105</b>
External contact fuse protection, safety contacts				
In accordance with the standard	<b>EN 60947-5-1</b>	<b>EN 60947-5-1</b>	<b>EN 60947-5-1</b>	<b>EN 60947-5-1</b>
Blow-out fuse, quick	<b>6 A</b>	<b>6 A</b>	<b>6 A</b>	<b>6 A</b>
Blow-out fuse, slow	<b>6,00 A</b>	<b>6,00 A</b>	<b>6,00 A</b>	<b>6,00 A</b>
Circuit breaker 24V AC/DC, characteristic B/C	<b>6 A</b>	<b>6 A</b>	<b>6 A</b>	<b>6 A</b>
Switch-off delay	<b>50 ms</b>	<b>50 ms</b>	<b>50 ms</b>	<b>50 ms</b>
Potential isolation	<b>yes</b>	<b>yes</b>	<b>yes</b>	<b>yes</b>
<b>Cascading output as standard output</b>	<b>773100</b>	<b>773103</b>	<b>773104</b>	<b>773105</b>
Number	<b>1</b>	<b>1</b>	<b>1</b>	<b>1</b>
Switching capability				
Voltage	<b>24 V</b>	<b>24 V</b>	<b>24 V</b>	<b>24 V</b>
Current	<b>0,2 A</b>	<b>0,2 A</b>	<b>0,2 A</b>	<b>0,2 A</b>
Power	<b>4,8 W</b>	<b>4,8 W</b>	<b>4,8 W</b>	<b>4,8 W</b>
Galvanic isolation	<b>No</b>	<b>No</b>	<b>No</b>	<b>No</b>
Short circuit-proof	<b>yes</b>	<b>yes</b>	<b>yes</b>	<b>yes</b>
Residual current at "0"	<b>0,5 mA</b>	<b>0,5 mA</b>	<b>0,5 mA</b>	<b>0,5 mA</b>
<b>Ethernet interface</b>	<b>773100</b>	<b>773103</b>	<b>773104</b>	<b>773105</b>
Number	<b>–</b>	<b>2</b>	<b>2</b>	<b>–</b>
<b>Serial interface</b>	<b>773100</b>	<b>773103</b>	<b>773104</b>	<b>773105</b>
Number of RS232 interfaces	<b>1</b>	<b>–</b>	<b>–</b>	<b>1</b>
<b>Times</b>	<b>773100</b>	<b>773103</b>	<b>773104</b>	<b>773105</b>
Switch-on delay	<b>5,00 s</b>	<b>5,00 s</b>	<b>5,00 s</b>	<b>5,00 s</b>
Supply interruption before de-energisation	<b>20 ms</b>	<b>20 ms</b>	<b>20 ms</b>	<b>20 ms</b>
Simultaneity, channel 1 and 2 max.	<b>3 s</b>	<b>3 s</b>	<b>3 s</b>	<b>3 s</b>
Simultaneity in the two-hand circuit	<b>0,5 s</b>	<b>0,5 s</b>	<b>0,5 s</b>	<b>0,5 s</b>
Max. cycle time of the device	<b>15 ms</b>	<b>15 ms</b>	<b>15 ms</b>	<b>15 ms</b>
Max. processing time for data communication	<b>–</b>	<b>50 ms</b>	<b>50 ms</b>	<b>–</b>



<b>Environmental data</b>	<b>773100</b>	<b>773103</b>	<b>773104</b>	<b>773105</b>
<b>Ambient temperature</b>				
In accordance with the standard	<b>EN 60068-2-14</b>	<b>EN 60068-2-14</b>	<b>EN 60068-2-14</b>	<b>EN 60068-2-14</b>
Temperature range	<b>0 - 60 °C</b>	<b>0 - 60 °C</b>	<b>-25 - 60 °C</b>	<b>-25 - 60 °C</b>
Forced convection in control cabinet off	<b>55 °C</b>	<b>55 °C</b>	–	–
<b>Storage temperature</b>				
In accordance with the standard	<b>EN 60068-2-1/-2</b>	<b>EN 60068-2-1/-2</b>	<b>EN 60068-2-1/-2</b>	<b>EN 60068-2-1/-2</b>
Temperature range	<b>-25 - 70 °C</b>	<b>-25 - 70 °C</b>	<b>-25 - 70 °C</b>	<b>-25 - 70 °C</b>
<b>Climatic suitability</b>				
In accordance with the standard	<b>EN 60068-2-30, EN 60068-2-78</b>	<b>EN 60068-2-30, EN 60068-2-78</b>	<b>EN 60068-2-30, EN 60068-2-78</b>	<b>EN 60068-2-30, EN 60068-2-78</b>
Humidity	<b>93 % r. h. at 40 °C</b>	<b>93 % r. h. at 40 °C</b>	<b>93 % r. h. at 40 °C</b>	<b>93 % r. h. at 40 °C</b>
<b>Condensation during operation</b>			<b>Short-term (only with separated extra low voltage)</b>	<b>Short-term (only with separated extra low voltage)</b>
	<b>Not permitted</b>	<b>Not permitted</b>		
<b>EMC</b>	<b>EN 61131-2</b>	<b>EN 61131-2</b>	<b>EN 61131-2</b>	<b>EN 61131-2</b>
<b>Vibration</b>				
In accordance with the standard	<b>EN 60068-2-6</b>	<b>EN 60068-2-6</b>	<b>EN 60068-2-6</b>	<b>EN 60068-2-6</b>
Frequency	<b>10,0 - 150,0 Hz</b>	<b>10,0 - 150,0 Hz</b>	<b>5,0 - 500,0 Hz</b>	<b>5,0 - 500,0 Hz</b>
Acceleration	<b>1g</b>	<b>1g</b>	<b>1g</b>	<b>1g</b>
<b>Broadband noise</b>				
In accordance with the standard	–	–	<b>EN 60068-2-64</b>	<b>EN 60068-2-64</b>
Frequency	–	–	<b>5 - 500 Hz</b>	<b>5 - 500 Hz</b>
Acceleration	–	–	<b>19 m/s<sup>2</sup> rms</b>	<b>19 m/s<sup>2</sup> rms</b>
<b>Corrosive gas check</b>				
SO <sub>2</sub> : Concentration 10 ppm, duration 10 days, passive	–	–	<b>DIN V 40046-36</b>	<b>DIN V 40046-36</b>
H <sub>2</sub> S: Concentration 1 ppm, duration 10 days, passive	–	–	<b>DIN V 40046-37</b>	<b>DIN V 40046-37</b>
<b>Shock stress</b>				
In accordance with the standard	<b>EN 60068-2-27</b>	<b>EN 60068-2-27</b>	<b>EN 60068-2-27</b>	<b>EN 60068-2-27</b>
Acceleration	<b>15g</b>	<b>15g</b>	<b>15g</b>	<b>15g</b>
Duration	<b>11 ms</b>	<b>11 ms</b>	<b>11 ms</b>	<b>11 ms</b>
<b>Max. operating height above sea level</b>	<b>2000 m</b>	<b>2000 m</b>	<b>2000 m</b>	<b>2000 m</b>

<b>Environmental data</b>	<b>773100</b>	<b>773103</b>	<b>773104</b>	<b>773105</b>
Airgap creepage				
In accordance with the standard	<b>EN 61131-2</b>	<b>EN 61131-2</b>	<b>EN 61131-2</b>	<b>EN 61131-2</b>
Overvoltage category	<b>III</b>	<b>III</b>	<b>III</b>	<b>III</b>
Pollution degree	<b>2</b>	<b>2</b>	<b>2</b>	<b>2</b>
Rated insulation voltage	<b>250 V</b>	<b>250 V</b>	<b>250 V</b>	<b>250 V</b>
Rated impulse withstand voltage	<b>6,00 kV</b>	<b>6,00 kV</b>	<b>6,00 kV</b>	<b>6,00 kV</b>
Protection type				
In accordance with the standard	<b>EN 60529</b>	<b>EN 60529</b>	<b>EN 60529</b>	<b>EN 60529</b>
Mounting area (e.g. control cabinet)	<b>IP54</b>	<b>IP54</b>	<b>IP54</b>	<b>IP54</b>
Housing	<b>IP20</b>	<b>IP20</b>	<b>IP20</b>	<b>IP20</b>
Terminals	<b>IP20</b>	<b>IP20</b>	<b>IP20</b>	<b>IP20</b>
<b>Potential isolation</b>	<b>773100</b>	<b>773103</b>	<b>773104</b>	<b>773105</b>
Potential isolation between	<b>SC output and system voltage</b>	<b>SC output and system voltage</b>	<b>SC output and system voltage</b>	<b>SC output and system voltage</b>
Type of potential isolation	<b>Protective separation</b>	<b>Protective separation</b>	<b>Protective separation</b>	<b>Protective separation</b>
Rated surge voltage	<b>2500 V</b>	<b>2500 V</b>	<b>2500 V</b>	<b>2500 V</b>
Potential isolation between	<b>RL output and system voltage</b>	<b>RL output and system voltage</b>	<b>RL output and system voltage</b>	<b>RL output and system voltage</b>
Type of potential isolation	<b>Protective separation</b>	<b>Protective separation</b>	<b>Protective separation</b>	<b>Protective separation</b>
Rated surge voltage	<b>6000 V</b>	<b>6000 V</b>	<b>6000 V</b>	<b>6000 V</b>
<b>Mechanical data</b>	<b>773100</b>	<b>773103</b>	<b>773104</b>	<b>773105</b>
Mounting position	<b>Horizontal on top hat rail</b>	<b>Horizontal on top hat rail</b>	<b>Horizontal on top hat rail</b>	<b>Horizontal on top hat rail</b>
DIN rail				
Top hat rail	<b>35 x 7,5 EN 50022</b>	<b>35 x 7,5 EN 50022</b>	<b>35 x 7,5 EN 50022</b>	<b>35 x 7,5 EN 50022</b>
Recess width	<b>27 mm</b>	<b>27 mm</b>	<b>27 mm</b>	<b>27 mm</b>
Max. cable length				
Max. cable length per input	<b>1,0 km</b>	<b>1,0 km</b>	<b>1,0 km</b>	<b>1,0 km</b>
Sum of individual cable lengths at the test pulse output	<b>40 km</b>	<b>40 km</b>	<b>40 km</b>	<b>40 km</b>
Material				
Bottom	<b>PPO UL 94 V0</b>	<b>PPO UL 94 V0</b>	<b>PPO UL 94 V0</b>	<b>PPO UL 94 V0</b>
Front	<b>ABS UL 94 V0</b>	<b>ABS UL 94 V0</b>	<b>ABS UL 94 V0</b>	<b>ABS UL 94 V0</b>
Connection type	<b>Spring-loaded terminal, screw terminal</b>	<b>Spring-loaded terminal, screw terminal</b>	<b>Spring-loaded terminal, screw terminal</b>	<b>Spring-loaded terminal, screw terminal</b>

<b>Mechanical data</b>	<b>773100</b>	<b>773103</b>	<b>773104</b>	<b>773105</b>
Conductor cross section with screw terminals				
1 core flexible	<b>0,25 - 1,50 mm<sup>2</sup>, 24 - 16 AWG</b>	<b>0,25 - 1,50 mm<sup>2</sup>, 24 - 16 AWG</b>	<b>0,25 - 1,50 mm<sup>2</sup>, 24 - 16 AWG</b>	<b>0,25 - 1,50 mm<sup>2</sup>, 24 - 16 AWG</b>
2 core with the same cross section, flexible without crimp connectors or with TWIN crimp connectors	<b>0,25 - 0,75 mm<sup>2</sup>, 24 - 20 AWG</b>	<b>0,25 - 0,75 mm<sup>2</sup>, 24 - 20 AWG</b>	<b>0,25 - 0,75 mm<sup>2</sup>, 24 - 20 AWG</b>	<b>0,25 - 0,75 mm<sup>2</sup>, 24 - 20 AWG</b>
Conductor cross section with screw terminals (relay outputs)				
1 core flexible	<b>0,25 - 2,50 mm<sup>2</sup>, 24 - 12 AWG</b>	<b>0,25 - 2,50 mm<sup>2</sup>, 24 - 12 AWG</b>	<b>0,25 - 2,50 mm<sup>2</sup>, 24 - 12 AWG</b>	<b>0,25 - 2,50 mm<sup>2</sup>, 24 - 12 AWG</b>
2 core with the same cross section, flexible without crimp connectors or with TWIN crimp connectors	<b>0,25 - 1,50 mm<sup>2</sup>, 24 - 16 AWG</b>	<b>0,25 - 1,50 mm<sup>2</sup>, 24 - 16 AWG</b>	<b>0,25 - 1,50 mm<sup>2</sup>, 24 - 16 AWG</b>	<b>0,25 - 1,50 mm<sup>2</sup>, 24 - 16 AWG</b>
Torque setting with screw terminals	<b>0,25 Nm</b>	<b>0,25 Nm</b>	<b>0,25 Nm</b>	<b>0,25 Nm</b>
Torque setting with screw terminals (relay outputs)	<b>0,50 Nm</b>	<b>0,50 Nm</b>	<b>0,50 Nm</b>	<b>0,50 Nm</b>
Stripping length with screw terminals	<b>7 mm</b>	<b>7 mm</b>	<b>7 mm</b>	<b>7 mm</b>
Stripping length with screw terminals (relay outputs)	<b>8 mm</b>	<b>8 mm</b>	<b>8 mm</b>	<b>8 mm</b>
Conductor cross section with spring-loaded terminals				
1 core flexible without crimp connector	<b>0,25 - 1,50 mm<sup>2</sup>, 24 - 16 AWG</b>	<b>0,25 - 1,50 mm<sup>2</sup>, 24 - 16 AWG</b>	<b>0,25 - 1,50 mm<sup>2</sup>, 24 - 16 AWG</b>	<b>0,25 - 1,50 mm<sup>2</sup>, 24 - 16 AWG</b>
1 core flexible with crimp connector	<b>0,25 - 0,75 mm<sup>2</sup>, 24 - 20 AWG</b>	<b>0,25 - 0,75 mm<sup>2</sup>, 24 - 20 AWG</b>	<b>0,25 - 0,75 mm<sup>2</sup>, 24 - 20 AWG</b>	<b>0,25 - 0,75 mm<sup>2</sup>, 24 - 20 AWG</b>

Mechanical data	773100	773103	773104	773105
Conductor cross section with spring-loaded terminals (relay outputs)				
1 core flexible without crimp connector	0,25 - 2,50 mm <sup>2</sup> , 24 - 12 AWG	0,25 - 2,50 mm <sup>2</sup> , 24 - 12 AWG	0,25 - 2,50 mm <sup>2</sup> , 24 - 12 AWG	0,25 - 2,50 mm <sup>2</sup> , 24 - 12 AWG
1 core flexible with crimp connector	0,25 - 1,50 mm <sup>2</sup> , 24 - 16 AWG	0,25 - 1,50 mm <sup>2</sup> , 24 - 16 AWG	0,25 - 1,50 mm <sup>2</sup> , 24 - 16 AWG	0,25 - 1,50 mm <sup>2</sup> , 24 - 16 AWG
Spring-loaded terminals: Terminal points per connection	1	1	1	1
Stripping length with spring-loaded terminals	9 mm	9 mm	9 mm	9 mm
Stripping length with spring-loaded terminals (relay outputs)	10 mm	10 mm	10 mm	10 mm
Dimensions				
Height	94,0 mm	94,0 mm	94,0 mm	94,0 mm
Width	135,0 mm	135,0 mm	135,0 mm	135,0 mm
Depth	121,0 mm	121,0 mm	121,0 mm	121,0 mm
Weight	499 g	518 g	538 g	519 g

Where standards are undated, the 2010-10 latest editions shall apply.

## 8.1 Safety characteristic data



### NOTICE

You must comply with the safety-related characteristic data in order to achieve the required safety level for your plant/machine.

Unit	Operating mode	EN ISO 13849-1: 2008 PL	EN ISO 13849-1: 2008 Category	EN 62061 SIL CL	EN 62061 PFH <sub>D</sub> [1/h]	EN ISO 13849-1: 2008 T <sub>M</sub> [year]
<b>Logic</b>						
CPU	2-channel	PL e	Cat. 4	SIL CL 3	4,90E-09	20
Expansion	–	PL e	Cat. 4	SIL CL 3	9,20E-09	20

Input						
SC inputs	1-channel	PL d	Cat. 2	SIL CL 2	2,50E-09	20
SC inputs	2-channel	PL e	Cat. 4	SIL CL 3	2,90E-10	20
SC inputs	Short circuit-forming safety mats	PL d	Cat. 3	SIL CL 2	1,81E-09	20
SC inputs	1-ch., pulsed light barrier	PL e	Cat. 4	SIL CL 3	2,50E-10	20
Cascad. inputs	–	PL e	Cat. 4	SIL CL 3	3,10E-10	20
Output						
SC outputs	1-channel	PL d	Cat. 2	SIL CL 2	7,00E-09	20
SC outputs	2-channel	PL e	Cat. 4	SIL CL 3	8,60E-10	20
Cascad. outputs	–	PL e	Cat. 4	SIL CL 3	4,91E-10	20
Relay outputs	1-channel	PL c	Cat. 1	-	2,90E-08	20
Relay outputs	2-channel	PL e	Cat. 4	SIL CL 3	3,00E-10	20

All the units used within a safety function must be considered when calculating the safety characteristic data.



**INFORMATION**

A safety function's SIL/PL values are **not** identical to the SIL/PL values of the units that are used and may be different. We recommend that you use the PAScal software tool to calculate the safety function's SIL/PL values.



**CAUTION!**

It is essential to consider the relay's service life graphs. The relay outputs' safety-related characteristic data is only valid if the values in the service life graphs are met.

The PFH value depends on the switching frequency and the load on the relay output. If the service life graphs are not accessible, the stated PFH value can be used irrespective of the switching frequency and the load, as the PFH value already considers the relay's B10d value as well as the failure rates of the other components.

## 9 Supplementary data

### 9.1 Service life graph for the relay contacts

The service life graphs indicate the number of cycles from which failures due to wear must be expected. The wear is mainly caused by the electrical load; the mechanical load is negligible.

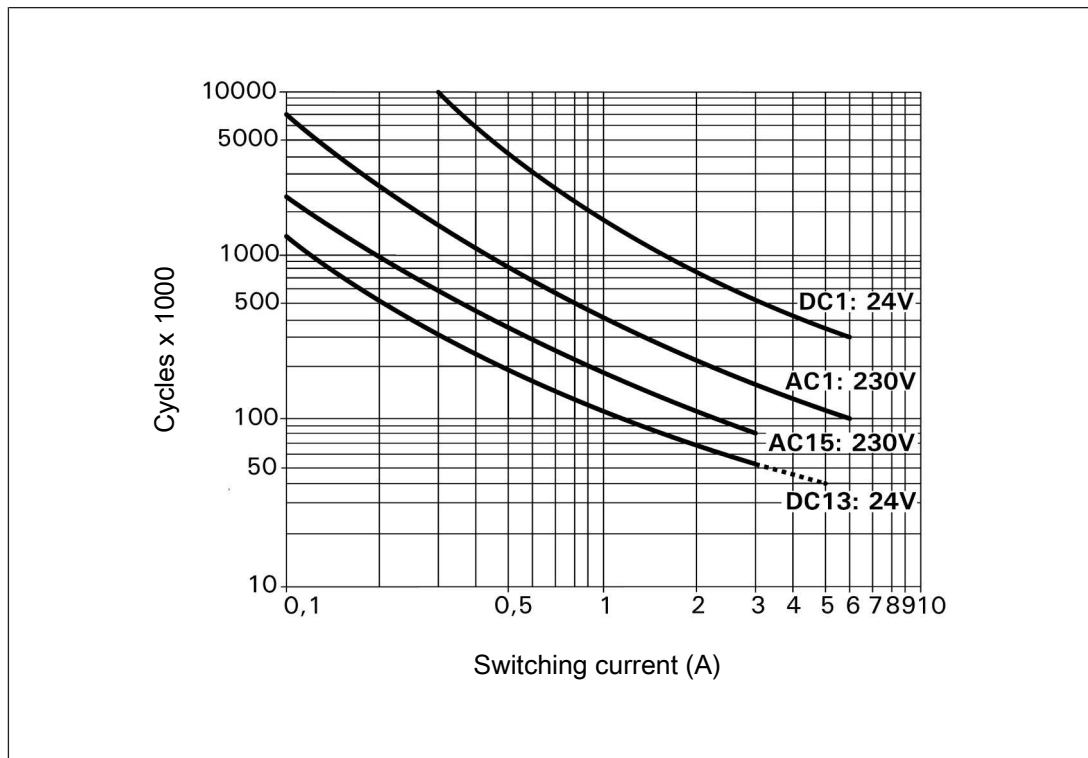

Fig.: Service life graphs at 24 VDC and 230 VAC

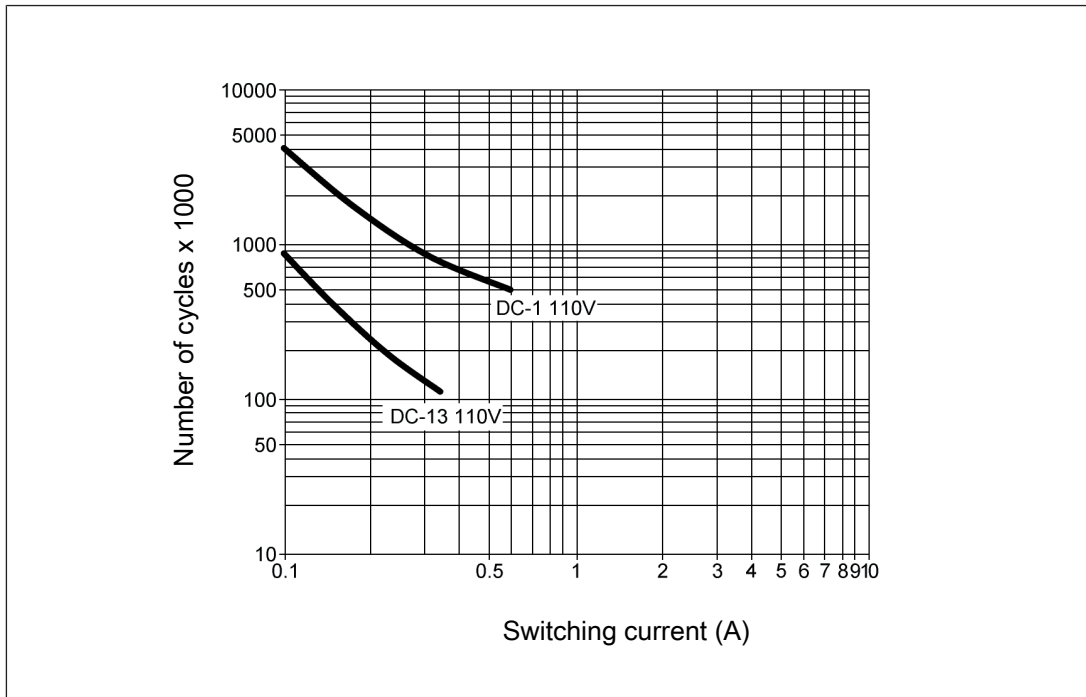

Fig.: Service life graphs at 110 VDC

### Example

- ▶ Inductive load: 0.2 A
- ▶ Utilisation category: AC15
- ▶ Contact service life: 1 000 000 cycles

Provided the application to be implemented requires fewer than 1 000 000 cycles, the PFH value (see [Technical details \[29\]](#)) can be used in the calculation.

To increase the service life, sufficient spark suppression must be provided on all relay contacts. With capacitive loads, any power surges that occur must be noted. With DC contactors, use flywheel diodes for spark suppression.

We recommend you use semiconductor outputs to switch 24 VDC loads.

## 10 Order reference

### 10.1 Product

Product type	Features	Order no.
PNOZ m1p	Base unit	773 100
PNOZ m1p coated version	Base unit, coated version	773 105
PNOZ m1p ETH	Base unit, Ethernet interface	773 103
PNOZ m1p ETH coated version	Base unit, Ethernet interface, coated version	773 104

### 10.2 Accessories

#### Connection terminals

Product type	Features	Order No.
Set spring terminals	1 set of spring-loaded terminals	783 100
Set screw terminals	1 set of screw terminals	793 100

#### Terminator, jumper

Product type	Features	Order No.
PNOZmulti bus terminator	Terminator	779 110
PNOZmulti bus terminator coated	Terminator, coated version	779 112
KOP-XE	Jumper	774 639
KOP-XE coated	Jumper, coated version	774 640



# ► Support

Technical support is available from Pilz round the clock.

## Americas

**Brazil**  
+55 11 97569-2804

**Canada**  
+1 888-315-PILZ (315-7459)

**Mexico**  
+52 55 5572 1300

**USA (toll-free)**  
+1 877-PILZUSA (745-9872)

## Asia

**China**  
+86 21 60880878-216

**Japan**  
+81 45 471-2281

**South Korea**  
+82 31 450 0680

## Australia

+61 3 95446300

## Europe

**Austria**  
+43 1 7986263-0

**Belgium, Luxembourg**  
+32 9 3217575

**France**  
+33 3 88104000

**Germany**  
+49 711 3409-444

**Ireland**  
+353 21 4804983

**Italy**  
+39 0362 1826711

## Scandinavia

+45 74436332

## Spain

+34 938497433

## Switzerland

+41 62 88979-30

## The Netherlands

+31 347 320477

## Turkey

+90 216 5775552

## United Kingdom

+44 1536 462203

## You can reach our international hotline on:

+49 711 3409-444  
support@pilz.com

Pilz develops environmentally-friendly products using ecological materials and energy-saving technologies. Offices and production facilities are ecologically designed, environmentally-aware and energy-saving. So Pilz offers sustainability, plus the security of using energy-efficient products and environmentally-friendly solutions.



Pilz GmbH & Co. KG  
Felix-Wankel-Straße 2  
73760 Ostfildern, Germany  
Tel.: +49 711 3409-0  
Fax: +49 711 3409-133  
info@pilz.com  
www.pilz.com

