



# WFS3-40P415

WFS

**FORK SENSORS**

**SICK**  
Sensor Intelligence.



### Ordering information

Type	Part no.
WFS3-40P415	6043919

Other models and accessories → [www.sick.com/WFS](http://www.sick.com/WFS)



### Detailed technical data

#### Features

<b>Functional principle</b>	Optical detection principle
<b>Dimensions (W x H x D)</b>	10 mm x 25 mm x 64.3 mm
<b>Housing design (light emission)</b>	Fork shaped
<b>Fork width</b>	3 mm
<b>Fork depth</b>	42 mm
<b>Minimum detectable object (MDO)</b>	Gap between Labels / Size of labels: 2 mm <sup>1)</sup>
<b>Label detection</b>	✓
<b>Light source</b>	LED, Infrared light
<b>Adjustment</b>	Plus/minus button (Teach-in, sensitivity, light/dark switching) Cable (dynamic Teach-in)
<b>Teach-in mode</b>	2-point teach-in Dynamic Teach-in
<b>Output function</b>	Light/darkswitching, selectable via button

<sup>1)</sup> Depends on the label thickness.

#### Interfaces

<b>IO-Link functions</b>	–
<b>Advanced functions</b>	–
<b>Fieldbus, industrial network</b>	-
<b>Type of fieldbus integration</b>	-

#### Mechanics/electronics

<b>Supply voltage</b>	10 V DC ... 30 V DC <sup>1)</sup>
<b>Ripple</b>	< 10 % <sup>2)</sup>

<sup>1)</sup> Limit values, reverse-polarity protected, operation in short-circuit protected network: max. 8 A.

<sup>2)</sup> May not exceed or fall below  $U_V$  tolerances.

<sup>3)</sup> Without load.

<sup>4)</sup> With light/dark ratio 1:1.

<sup>5)</sup> Signal transit time with resistive load.

<b>Power consumption</b>	20 mA <sup>3)</sup>
<b>Switching frequency</b>	10 kHz <sup>4)</sup>
<b>Response time</b>	50 µs <sup>5)</sup>
<b>Stability of response time</b>	± 20 µs
<b>Jitter</b>	40 µs
<b>Switching output</b>	PNP
<b>Switching output (voltage)</b>	PNP: HIGH = $V_{S-} \leq 2 \text{ V}$ / LOW approx. 0 V
<b>Switching output</b>	Light/dark switching
<b>Output current <math>I_{\text{max}}</math></b>	100 mA
<b>Input, teach-in (ET)</b>	PNP Teach: $U > 5 \text{ V} \dots < U_V$ Run: $U < 4 \text{ V}$
<b>Initialization time</b>	20 ms
<b>Connection type</b>	Male connector M8, 4-pin
<b>Ambient light immunity</b>	≤ 10,000 lx
<b>Protection class</b>	III
<b>Circuit protection</b>	$U_V$ connections, reverse polarity protected Output Q short-circuit protected Interference pulse suppression
<b>Enclosure rating</b>	IP65
<b>Weight</b>	Approx. 36 g
<b>Housing material</b>	PA (glass-fiber reinforced)

- 1) Limit values, reverse-polarity protected, operation in short-circuit protected network: max. 8 A.
- 2) May not exceed or fall below  $U_V$  tolerances.
- 3) Without load.
- 4) With light/dark ratio 1:1.
- 5) Signal transit time with resistive load.

### Ambient data

<b>Ambient operating temperature</b>	-20 °C ... +60 °C <sup>1)</sup>
<b>Ambient storage temperature</b>	-30 °C ... +80 °C
<b>Shock load</b>	According to EN 60068-2-27
<b>UL File No.</b>	NRKH.E191603

- 1) Do not bend below 0 °C.

### Classifications

<b>ECl@ss 5.0</b>	27270909
<b>ECl@ss 5.1.4</b>	27270909
<b>ECl@ss 6.0</b>	27270909
<b>ECl@ss 6.2</b>	27270909
<b>ECl@ss 7.0</b>	27270909
<b>ECl@ss 8.0</b>	27270909
<b>ECl@ss 8.1</b>	27270909
<b>ECl@ss 9.0</b>	27270909

<b>ETIM 5.0</b>	EC002720
<b>ETIM 6.0</b>	EC002720
<b>UNSPSC 16.0901</b>	39121528

### Dimensional drawing (Dimensions in mm (inch))

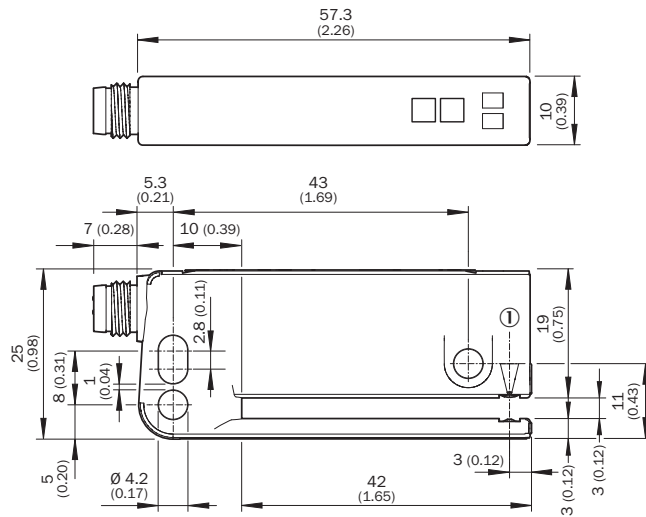

① Optical axis

### Adjustments

Adjustment: teach-in via plus/minus buttons (WFxx-B416)

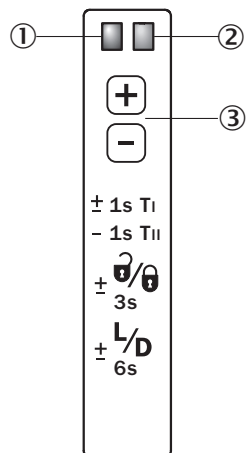

- ① Function signal indicator (yellow), switching output
- ② Function indicator (red)
- ③ “+”/“-” buttons and function button

## Connection diagram

cd-092

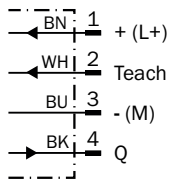

## Concept of operation

**1. Position label or substrate in the active area of the fork sensor**

**2. Move multiple labels through the fork sensor**

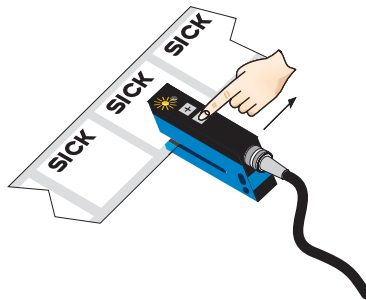
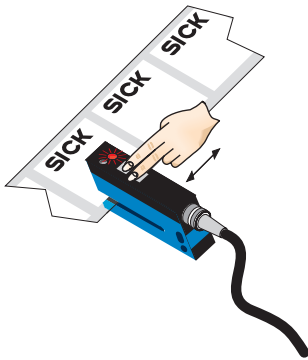

Press both the “+” and “-” buttons together, hold > 1 s and then release the teach-in buttons. The red LED flashes.

Press “-” button, teach-in process is finished.

### Notes

Switching threshold adaptation:

Only, the first teach-in procedure after switching on is permanently stored. Teach-in can be repeated cyclically. Switching output also during teach-in active.

- + Once teach-in process is complete, the switching threshold can be adjusted at any time using the “+” or “-” button. To make minor adjustments, press the “+” or “-” button once. To configure settings quickly, keep the “+” or “-” button pressed for longer.



$\pm \frac{3}{3s}$  Press both the “+” and “-” buttons together (3 seconds) to lock the device and prevent unintentional actuation.

$\pm \frac{L/D}{6s}$  Press both the “+” and “-” buttons together (6 seconds) to define the switching function (light/dark switching). Standard setting: Q = light switching.

Teach-in (static): Setting the switching threshold without movements of label, cf. operating instruction.

### Recommended accessories

Other models and accessories → [www.sick.com/WFS](http://www.sick.com/WFS)

	Brief description	Type	Part no.
Universal bar clamp systems			
	Mounting bar, straight, steel, zinc coated	BEF-M12GF-A	2059414
Plug connectors and cables			
	Head A: female connector, M8, 4-pin, straight, A-coded Head B: Flying leads Cable: Sensor/actuator cable, PVC, unshielded, 2 m	YF8U14-020VA3XLEAX	2095888
	Head A: female connector, M8, 4-pin, straight, A-coded Head B: Flying leads Cable: Sensor/actuator cable, PVC, unshielded, 5 m	YF8U14-050VA3XLEAX	2095889
	Head A: female connector, M8, 4-pin, straight, A-coded Head B: Flying leads Cable: Sensor/actuator cable, PVC, unshielded, 10 m	YF8U14-100VA3XLEAX	2095890
	Head A: female connector, M8, 4-pin, angled, A-coded Head B: Flying leads Cable: Sensor/actuator cable, PVC, unshielded, 2 m	YG8U14-020VA3XLEAX	2095962
	Head A: female connector, M8, 4-pin, angled, A-coded Head B: Flying leads Cable: Sensor/actuator cable, PVC, unshielded, 5 m	YG8U14-050VA3XLEAX	2095963
	Head A: female connector, M8, 4-pin, angled, A-coded Head B: Flying leads Cable: Sensor/actuator cable, PVC, unshielded, 10 m	YG8U14-100VA3XLEAX	2095964
	Head A: female connector, M8, 4-pin, straight Head B: - Cable: unshielded	DOS-0804-G	6009974
	Head A: female connector, M8, 4-pin, angled Head B: - Cable: unshielded	DOS-0804-W	6009975

## SICK AT A GLANCE

SICK is one of the leading manufacturers of intelligent sensors and sensor solutions for industrial applications. A unique range of products and services creates the perfect basis for controlling processes securely and efficiently, protecting individuals from accidents and preventing damage to the environment.

We have extensive experience in a wide range of industries and understand their processes and requirements. With intelligent sensors, we can deliver exactly what our customers need. In application centers in Europe, Asia and North America, system solutions are tested and optimized in accordance with customer specifications. All this makes us a reliable supplier and development partner.

Comprehensive services complete our offering: SICK LifeTime Services provide support throughout the machine life cycle and ensure safety and productivity.

For us, that is “Sensor Intelligence.”

## WORLDWIDE PRESENCE:

Contacts and other locations –[www.sick.com](http://www.sick.com)