

TMM55, TMS/TMM88

Inclination sensors with current / voltage interface

SICK
Sensor Intelligence.



Described product

1- and 2-dimensional inclination sensors:

TMM55E

TMS88A

TMM88A

TMS88B

TMM88B

Manufacturer

SICK AG
Erwin-Sick-Str. 1
79183 Waldkirch
Germany

Legal information

This work is protected by copyright. Any rights derived from the copyright shall be reserved for SICK AG. Reproduction of this document or parts of this document is only permissible within the limits of the legal determination of Copyright Law. Any modification, abridgment or translation of this document is prohibited without the express written permission of SICK AG.

The trademarks stated in this document are the property of their respective owner.

© SICK AG. All rights reserved.

Original document

This document is an original document of SICK AG.



Contents

1	About this document.....	4
1.1	Function of this document.....	4
1.2	Explanation of symbols.....	4
2	Safety information.....	5
2.1	Intended use.....	5
2.2	Incorrect use.....	5
2.3	Requirements for the qualification of personnel.....	5
3	Overview.....	6
4	Technical data.....	7
4.1	Notice.....	7
4.2	Technical data for TMS88A-PKC360 + TMM88A-PKC090.....	7
4.3	Technical data for TMS88A-PLC360 + TMM88A-PLC090.....	8
4.4	Technical data for TMS88B-AKC360 + TMM88B-AKC090.....	10
4.5	Technical data for TMS88B-ALC360 + TMM88B-ALC090.....	12
4.6	Technical data for TMS88B-PKC360 + TMM88B-PKC090.....	13
4.7	Technical data for TMM88B-PLC360 + TMS88B-PLC090.....	15
4.8	Technical data for TMM55E-PMHxxx.....	16
4.9	Technical data for TMM55E-POHxxx.....	17
5	Transport and storage.....	19
5.1	Transport.....	19
5.2	Transport inspection.....	19
5.3	Storage.....	19
6	Mounting.....	20
6.1	Layout of the fixing holes.....	20
7	Connection.....	21
7.1	Pin assignment.....	21
7.2	Circuit diagram for TMx88.....	21
7.3	Length of cable and minimum supply voltage for current output.....	22
7.4	Load resistances.....	22
8	Description of operation TMM55.....	26
8.1	Calculating the inclination angle for TMM55E.....	26
9	Description of operation TMS/TMM88.....	27
9.1	Axis assignment/Reversal of counting direction.....	27
9.2	Zero-point setting.....	27
9.3	Digital filters.....	27
9.4	Status LED.....	29

1 About this document

1.1 Function of this document

These operating instructions are intended to give technical personnel working for the machine manufacturer or machine operator instructions on the mounting, electrical installation, commissioning, and operation of the TMM55, TMS88 and TMM88 inclination sensors.

These operating instructions do not provide information on operating the machine in which an inclination sensor is integrated. For information about this, refer to the operating instructions of the particular machine.

1.2 Explanation of symbols

Warnings in these operating instructions are labeled with symbols. The warnings are introduced by signal words that indicate the extent of the danger. These warnings must be observed at all times and care must be taken to avoid accidents, personal injury, and material damage.



DANGER

... indicates a situation of imminent danger, which will lead to a fatality or serious injuries if not prevented.



WARNING

... indicates a potentially dangerous situation, which may lead to a fatality or serious injuries if not prevented.



CAUTION

... indicates a potentially dangerous situation, which may lead to minor/slight injuries if not prevented.



NOTICE

... indicates a potentially harmful situation, which may lead to material damage if not prevented.



NOTE

... highlights useful tips and recommendations as well as information for efficient and trouble-free operation.

2 Safety information

2.1 Intended use

The TMS/TMM inclination sensors are measuring devices consisting of an electronic sensor and integrated evaluation electronics. The tasks for which the measuring device is designed include recording inclinations in solar thermal energy, photovoltaics or heavy-duty vehicle applications.

SICK AG assumes no liability for losses or damage arising from the use of the product, either directly or indirectly. This applies in particular to use of the product that does not conform to its intended purpose and is not described in this documentation.

2.2 Incorrect use

The inclination sensors do not constitute safety components according to the EC Machinery Directive (2006/42/EC). The inclination sensors must not be used in explosion-hazardous areas. Any other use that is not described as intended use is prohibited. Any use of accessories not specifically approved by SICK AG is at your own risk.



WARNING

Danger due to improper use!

Any incorrect use can result in dangerous situations.

Therefore, take note of the following information:

- Use only in accordance with the intended use.
- All information in these operating instructions must be strictly complied with.

2.3 Requirements for the qualification of personnel

The personnel who work on and with the device must be suitably authorized, trained, and sufficiently qualified. Skilled personnel refers to the following:

- A member of staff who has received specialist training, which is backed up by additional knowledge and experience.
- A member of staff who knows the relevant technical terms and regulations.
- A member of staff who can appraise the work assigned to them, recognize potential hazards, and take suitable safety precautions.

Task	Qualification
Mounting	<ul style="list-style-type: none"> • Technical training • Knowledge of current workplace safety regulations
Electrical installation	<ul style="list-style-type: none"> • Electrotechnical training • Knowledge of the current electrotechnical workplace safety regulations • Knowledge of the operation and control of the sensor in the particular application
Commissioning, configuration, and operation	<ul style="list-style-type: none"> • Technical training • Knowledge of the operation and control of the sensor in the particular application

Table 1: Skilled personnel qualifications

3 Overview

Properties of TMS/TMM88

- Inclination sensors with measuring range: $360^\circ / \pm 90^\circ$ (X/Y)
- High accuracy up to 0.02°
- Compensated cross sensitivity
- Configurable vibration suppression
- Freely configurable current / voltage interface (via PGT-12-Pro)
- Functions:
 - Teach input for zero-point setting when installed
 - Limiting of final value
 - Counting direction and axis assignment of outputs can be configured
 - Digital filter (critically damped (default) or Butterworth low pass, 8th order)
- Suitable for industrial use:
 - Temperature range: -40°C to $+80^\circ\text{C}$
 - Enclosure rating: IP65/67

TMS88 1-dimensional inclination sensors are used to measure inclinations in the 360° range. TMM88 2-dimensional inclination sensors are used to measure inclinations in 2 ranges (X/Y) of $\pm 90^\circ$. To ensure high levels of accuracy, the sensors are calibrated at the factory.

A compact and rugged design makes the sensors an ideal solution for measuring angles in harsh environments. They are compatible for use in all manner of applications in industry and automotive engineering.

Properties of TMM55E

- Inclination sensors with measuring range: $\pm 10^\circ / \pm 45^\circ / \pm 60^\circ$ (X/Y)
- Sinusoidal output, high accuracy
- Fixed set current / voltage interface
- Rugged impact-resistant small plastic housing
- Suitable for industrial use:
 - Temperature range: -40°C to $+80^\circ\text{C}$
 - Enclosure rating: IP65/67

TMM55 2-dimensional inclination sensors are used to measure inclinations in 2 ranges (X/Y) of $\pm 10^\circ$, $\pm 45^\circ$, and $\pm 60^\circ$. To ensure high levels of accuracy, the sensors are calibrated at the factory.

A compact and rugged design makes the sensor an ideal solution for measuring angles in harsh environments. It is compatible for use in all manner of applications in industry and automotive engineering.

Areas of application

- Agricultural and forestry machinery
- Construction machinery and special-purpose vehicles
- Solar thermal energy and photovoltaics
- Automated guided systems
- Crane and lifting technology

4 Technical data

4.1 Notice



NOTE

In this chapter you will find an extract from the technical data. For more details, see the product information TMM55, TMS/TMM61, TMS/TMM88 (8019181)

4.2 Technical data for TMS88A-PKC360 + TMM88A-PKC090

General parameters ¹	TMS88A-PKC360			TMM88A-PKC090		
Number of measuring axes	1			2		
Measuring range	360°			±90°		
Resolution	0.01°			0.01°		
Accuracy	Range 0...360°	Typical ±0.04°	Maximum ±0.12°	Range up to ±60° up to ±70° up to ±80° up to ±85°	Typical ±0.02° ±0.04° ±0.08° ±0.16°	Maximum ±0.06° ±0.12° ±0.24° ±0.48°
Cross sensitivity (compensated)	-			Typ. ±0.09° (±0.10%FS) Max. ±0.45° (±0.50%FS)		
Temperature coefficient (zero point)	Typ. +0.0088 °/K, -0.0102 °/K					
Sampling rate	100 Hz					
Limit frequency	Typ. 20 Hz, 2nd order (no digital filter) / 0.1 ... 25 Hz, 8th order (with digital filter)					
Operating temperature	-40 °C to +80 °C					
Properties						
Current interface	Freely configurable output in the range 0...20.48 mA (factory setting: 4...20 mA) Freely configurable angle range 0...360° / ±90°					
Functions	Teach input for zero-point setting when installed Limitation of final value, counting direction, and axis assignment of outputs can be configured Digital filter (critically damped (default) or Butterworth low pass, 8th order)					
Electrical parameters						
Supply voltage	17 ... 35 VDC					
Current consumption	40 mA @ 24 V + I _{loop}					
Outputs (short-circuit protected)	Inductive load less than 1 H, load dependent on input voltage (see "Load resistances", page 22)					
Mechanical parameters						
Connection	5-pin M12 sensor plug connector (male connector)					
Enclosure rating	IP65/67					

Table 2: Technical data for TMx88A-PKCxxx

General parameters ¹	TMS88A-PKC360	TMM88A-PKC090
Dimensions / Weight	Plastic housing: 66 mm x 90 mm x 36 mm / approx. 200 g	

Table 2: Technical data for TMx88A-PKCxxx

¹ All specified angular accuracies apply after a run-in time of 10 min at 25 °C, limit frequency 0.3 Hz, absolute calibration accuracy (at 25 °C): ±0.05°

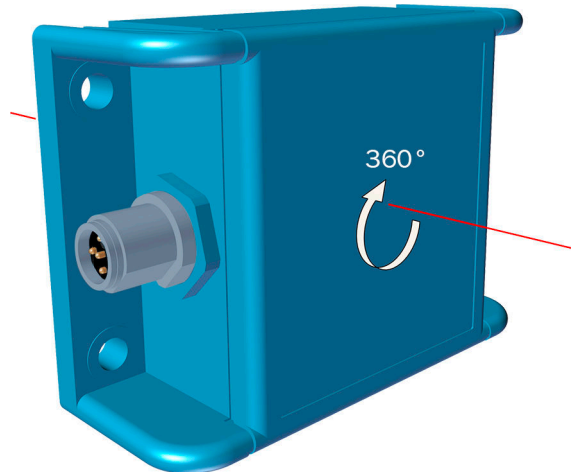

Figure 1: TMS88A measuring axis (large plastic housing)

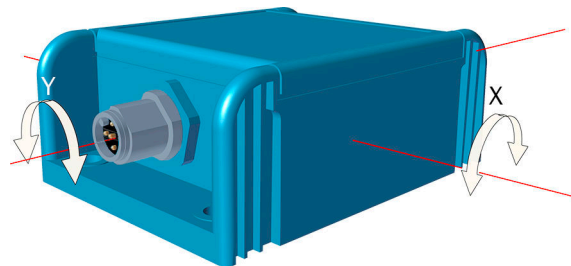

Figure 2: TMS88A measuring axes (large plastic housing)

4.3 Technical data for TMS88A-PLC360 + TMM88A-PLC090

General parameters ¹	TMS88A-PLC360			TMM88A-PLC090		
Number of measuring axes	1			2		
Measuring range	360°			±90°		
Resolution	0.01°			0.01°		
Accuracy	Range 0...360°	Typical ±0.04°	Maximum ±0.12°	Range up to ±60° up to ±70° up to ±80° up to ±85°	Typical ±0.02° ±0.04° ±0.08° ±0.16°	Maximum ±0.06° ±0.12° ±0.24° ±0.48°
Cross sensitivity (compensated)	-			Typ. ±0.09° (±0.10%FS) Max. ±0.45° (±0.50%FS)		
Temperature coefficient (zero point)	Typ. ±0.0083 °/K					

Table 3: Technical data for TMx88A-PLCxxx

General parameters ¹	TMS88A-PLC360	TMM88A-PLC090
Sampling rate	100 Hz	
Limit frequency	Typ. 20 Hz, 2nd order (no digital filter) / 0.1 ... 25 Hz, 8th order (with digital filter)	
Operating temperature	-40 °C to +80 °C	
Properties		
Voltage interface	Freely configurable output in the range -10.48...10.48 V (factory setting: 0...10 V) Freely configurable angle range 0...360° / ±90°	
Functions	Teach input for zero-point setting when installed Limitation of final value, counting direction, and axis assignment of outputs can be configured Digital filter (critically damped (default) or Butterworth low pass, 8th order)	
Electrical parameters		
Supply voltage	10 ... 35 VDC	
Current consumption	55 mA @ 24 V	
Outputs (short-circuit protected)	Capacitive load less than 1.2 µF, resistance greater than 2 kΩ	
Mechanical parameters		
Connection	5-pin M12 sensor plug connector (male connector)	
Enclosure rating	IP65/67	
Dimensions / Weight	Plastic housing: 66 mm x 90 mm x 36 mm / approx. 200 g	

Table 3: Technical data for TMx88A-PLCxxx

- ¹ All specified angular accuracies apply after a run-in time of 10 min at 25 °C, limit frequency 0.3 Hz, absolute calibration accuracy (at 25 °C): ±0.05°

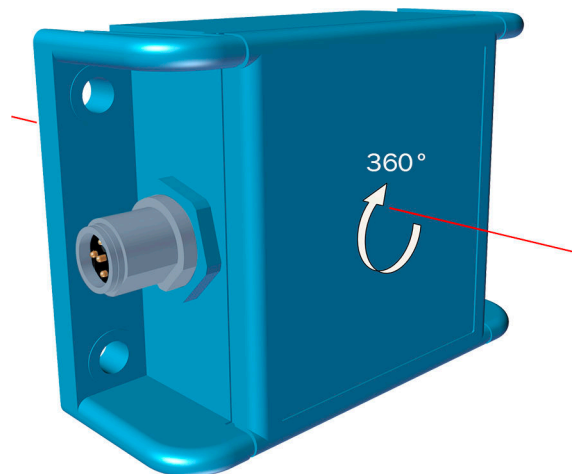

Figure 3: TMS88A measuring axis (large plastic housing)

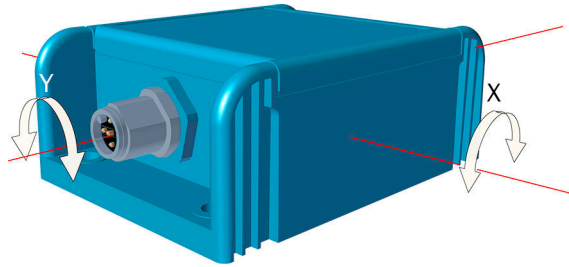

Figure 4: TMS88A measuring axes (large plastic housing)

4.4 Technical data for TMS88B-AKC360 + TMM88B-AKC090

General parameters ¹	TMS88B-AKC360			TMM88B-AKC090		
Number of measuring axes	1			2		
Measuring range	360°			±90°		
Resolution	0.01°			0.01°		
Accuracy	Range 0...360°	Typical ±0.15°	Maximum ±0.25°	Range up to ±60° up to ±80°	Typical ±0.10° ±0.20°	Maximum ±0.20° ±0.40°
Cross sensitivity (compensated)	-			Typ. ±0.10° (±0.11%FS) Max. ±0.20° (±0.22%FS)		
Temperature coefficient (zero point)	Typ. ±0.01°/K					
Sampling rate	80 Hz					
Limit frequency	Typ. 20 Hz, 2nd order (no digital filter) / 0.1 ... 25 Hz, 8th order (with digital filter)					
Operating temperature	-40 °C to +80 °C					
Properties						
Current interface	Freely configurable output in the range 4...20 mA (factory setting: 4...20 mA) Freely configurable angle range 0...360° / ±90°					
Functions	Teach input for zero-point setting when installed Limitation of final value, counting direction, and axis assignment of outputs can be configured Digital filter (critically damped (default) or Butterworth low pass, 8th order)					
Electrical parameters						
Supply voltage	16 ... 35 VDC					
Current consumption	35 mA @ 24 V + I _{loop}					
Outputs (short-circuit protected)	Inductive load less than 50 mH, permissible load dependent on input voltage (see "Load resistances", page 22)					
Mechanical parameters						
Connection	5-pin M12 sensor plug connector (male connector)					
Enclosure rating	IP65/67					

Table 4: Technical data for TMx88B-AKCxxx

General parameters ¹	TMS88B-AKC360	TMM88B-AKC090
Dimensions / Weight	Aluminum housing: 58 mm x 90 mm x 31 mm / approx. 200 g	

Table 4: Technical data for TMx88B-AKCxxx

¹ All specified angular accuracies apply after a run-in time of 10 min at 25 °C, limit frequency 0.3 Hz, absolute calibration accuracy (at 25 °C): ±0.05 °

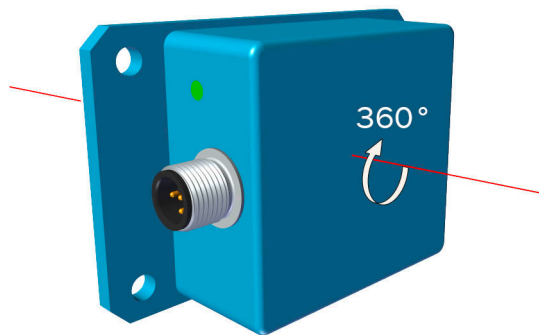

Figure 5: TMS88B measuring axis (aluminum housing)

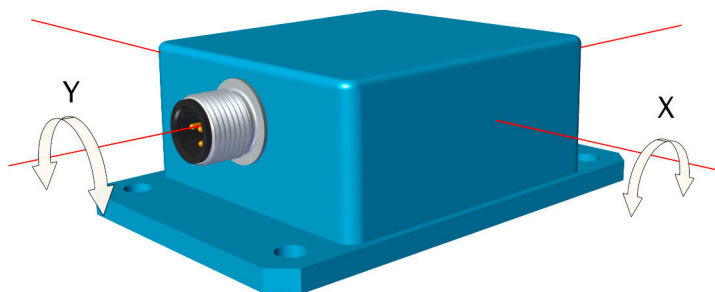

Figure 6: TMM88B measuring axes (aluminum housing)

4.5 Technical data for TMS88B-ALC360 + TMM88B-ALC090

General parameters ¹	TMS88B-ALC360			TMM88B-ALC090		
Number of measuring axes	1			2		
Measuring range	360°			±90°		
Resolution	0.01°			0.01°		
Accuracy	Range 0...360°	Typical ±0.15°	Maximum ±0.25°	Range up to ±60° up to ±80°	Typical ±0.10° ±0.20°	Maximum ±0.20° ±0.40°
Cross sensitivity (compensated)	-			Typ. ±0.10° (±0.11%FS) Max. ±0.20° (±0.22%FS)		
Temperature coefficient (zero point)	Typ. ±0.01°/K					
Sampling rate	80 Hz					
Limit frequency	Typ. 20 Hz, 2nd order (no digital filter) / 0.1 ... 25 Hz, 8th order (with digital filter)					
Operating temperature	-40 °C to +80 °C					
Properties						
Voltage interface	Freely configurable output in the range 0...10.48 V (factory setting: 0...10 V) Freely configurable angle range 0...360° / ±90°					
Functions	Teach input for zero-point setting when installed Limitation of final value, counting direction, and axis assignment of outputs can be configured Digital filter (critically damped (default) or Butterworth low pass, 8th order)					
Electrical parameters						
Supply voltage	16 ... 35 VDC					
Current consumption	35 mA @ 24 V					
Outputs (short-circuit protected)	Capacitive load less than 1 µF, resistance greater than 1 kΩ					
Mechanical parameters						
Connection	5-pin M12 sensor plug connector (male connector)					
Enclosure rating	IP65/67					
Dimensions / Weight	Aluminum housing: 58 mm x 90 mm x 31 mm / approx. 200 g					

Table 5: Technical data for TMx88B-ALCxxx

¹ All specified angular accuracies apply after a run-in time of 10 min at 25 °C, limit frequency 0.3 Hz, absolute calibration accuracy (at 25 °C): ±0.05°

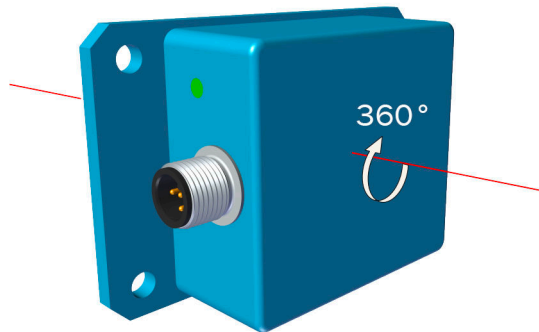

Figure 7: TMS88B measuring axis (aluminum housing)

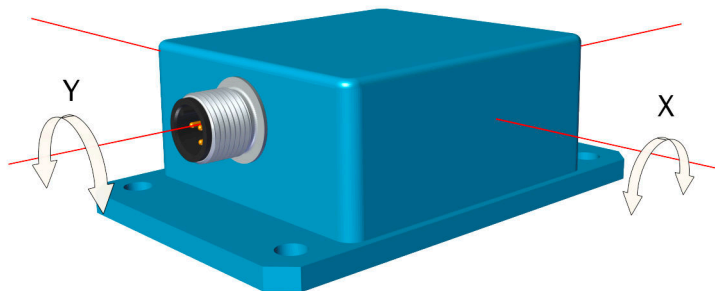

Figure 8: TMM88B measuring axes (aluminum housing)

4.6 Technical data for TMS88B-PKC360 + TMM88B-PKC090

General parameters ¹	TMS88B-PKC360			TMM88B-PKC090		
Number of measuring axes	1			2		
Measuring range	360°			±90°		
Resolution	0.01°			0.01°		
Accuracy	Range 0...360°	Typical ±0.15°	Maximum ±0.25°	Range up to ±60° up to ±80°	Typical ±0.10° ±0.20°	Maximum ±0.20° ±0.40°
Cross sensitivity (compensated)	-			Typ. ±0.10° (±0.11%FS) Max. ±0.20° (±0.22%FS)		

Table 6: Technical data for TMx88B-PKCxxx

General parameters ¹	TMS88B-PKC360	TMM88B-PKC090
Temperature coefficient (zero point)	Typ. $\pm 0.01^\circ/\text{K}$	
Sampling rate	80 Hz	
Limit frequency	Typ. 20 Hz, 2nd order (no digital filter) / 0.1 ... 25 Hz, 8th order (with digital filter)	
Operating temperature	-40 °C to +80 °C	
Properties		
Current interface	Freely configurable output in the range 4...20 mA (factory setting: 4...20 mA) Freely configurable angle range 0...360° / $\pm 90^\circ$	
Functions	Teach input for zero-point setting when installed Limitation of final value, counting direction, and axis assignment of outputs can be configured Digital filter (critically damped (default) or Butterworth low pass, 8th order)	
Electrical parameters		
Supply voltage	16 ... 35 VDC	
Current consumption	35 mA @ 24 V + I_{loop}	
Outputs (short-circuit protected)	Inductive load less than 50 mH, load 500 Ω (standard) Permissible load dependent on input voltage (see "Load resistances", page 22)	
Mechanical parameters		
Connection	5-pin M12 sensor plug connector (male connector)	
Enclosure rating	IP65/67	
Dimensions / Weight	Plastic housing: 66 mm x 90 mm x 36 mm / approx. 200 g	

Table 6: Technical data for TMx88B-PKCxxx

¹ All specified angular accuracies apply after a run-in time of 10 min at 25 °C, limit frequency 0.3 Hz, absolute calibration accuracy (at 25 °C): $\pm 0.05^\circ$

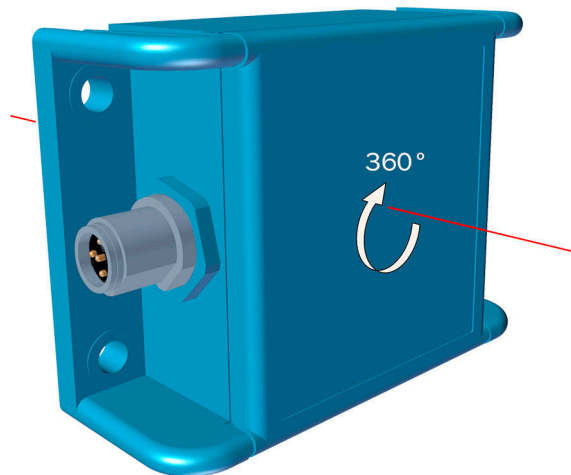

Figure 9: TMS88B measuring axis (large plastic housing)

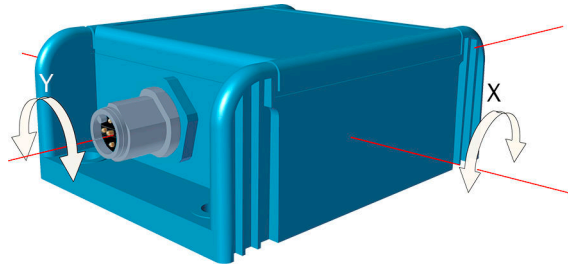

Figure 10: TMS88B measuring axes (large plastic housing)

4.7 Technical data for TMM88B-PLC360 + TMS88B-PLC090

General parameters ¹	TMM88B-PLC360			TMS88B-PLC090		
	Number of measuring axes	1			2	
Measuring range	360°			±90°		
Resolution	0.01°			0.01°		
Accuracy	Range 0...360°	Typical ±0.15°	Maximum ±0.25°	Range up to ±60° up to ±80°	Typical ±0.10° ±0.20°	Maximum ±0.20° ±0.40°
Cross sensitivity (compensated)	-			Typ. ±0.10° (±0.11%FS) Max. ±0.20° (±0.22%FS)		
Temperature coefficient (zero point)	Typ. ±0.01°/K					
Sampling rate	80 Hz					
Limit frequency	Typ. 20 Hz, 2nd order (no digital filter) / 0.1 ... 25 Hz, 8th order (with digital filter)					
Operating temperature	-40 °C to +80 °C					
Properties						
Voltage interface	Freely configurable output in the range 0...10.48 V (factory setting: 0...10 V) Freely configurable angle range 0...360° / ±90°					
Functions	Teach input for zero-point setting when installed Limitation of final value, counting direction, and axis assignment of outputs can be configured Digital filter (critically damped (default) or Butterworth low pass, 8th order)					
Electrical parameters						
Supply voltage	16 ... 35 VDC					
Current consumption	35 mA @ 24 V					
Outputs (short-circuit protected)	Capacitive load less than 1 µF, resistance greater than 1 kΩ					
Mechanical parameters						
Connection	5-pin M12 sensor plug connector (male connector)					
Enclosure rating	IP65/67					

Table 7: Technical data for TMx88B-PLCxxx

General parameters ¹	TMM88B-PLC360	TMS88B-PLC090
Dimensions / Weight	Plastic housing: 66 mm x 90 mm x 36 mm / approx. 200 g	

Table 7: Technical data for TMM88B-PLCxxx

¹ All specified angular accuracies apply after a run-in time of 10 min at 25 °C, limit frequency 0.3 Hz, absolute calibration accuracy (at 25 °C): ±0.05°

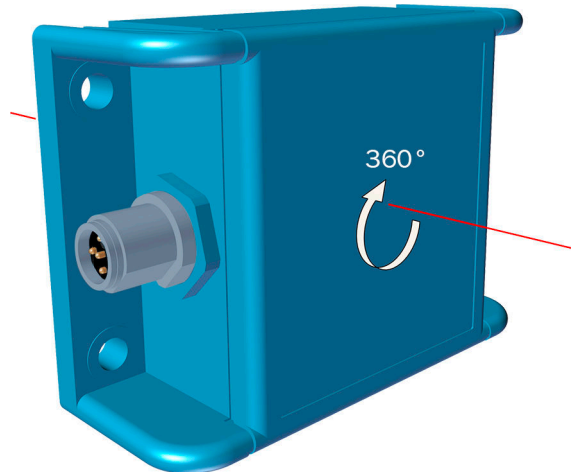

Figure 11: TMS88B measuring axis (large plastic housing)

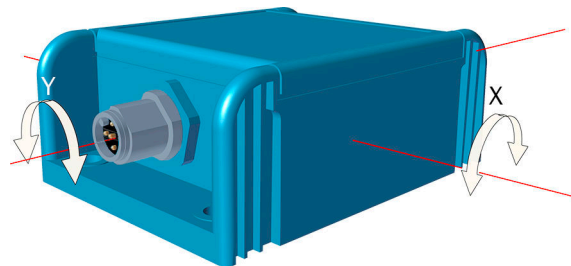

Figure 12: TMM88B measuring axes (large plastic housing)

4.8 Technical data for TMM55E-PMHxxx

General parameters ¹	TMM55E-PMH010	TMM55E-PMH045	TMM55E-PMH060
Number of measuring axes	2	2	2
Measuring range	±10°	±45°	±60°
Resolution (zero point)	0.01°	0.05°	0.06°
Angle deviations, max. (in measuring range)	±0.15°	±0.30°	±0.50°
Cross sensitivity	Typ. ±0.25° (±2.5%FS) Max. ±0.5° (±5%FS)	Typ. ±0.9° (±2.0%FS) Max. ±1.8° (±4.0%FS)	Typ. ±1.2° (±2.0%FS) Max. ±2.4° (±4.0%FS)
Temperature coefficient (zero point)	Max. ±0.009 °/K (in relation to the reference temperature 25 °C)		
Limit frequency	Typ. 18 Hz		

Table 8: Technical data for TMM55E-PMHxxx

General parameters ¹	TMM55E-PMH010	TMM55E-PMH045	TMM55E-PMH060
Operating temperature	-40 °C to +80 °C		
Properties			
Interface	Current output: 4...20 mA, sinusoidal Max. load resistance at U = 11 V: 250 Ω		
Calculation formula Angle value [°]	$\alpha = \arcsin\left[\frac{I_{out} - 12mA}{8mA} * \sin(\maxvalue)\right]$		
Electrical parameters			
Supply voltage	11 ... 30 VDC		
Current consumption	15 mA .. 45 mA		
Mechanical parameters			
Connection	0.2 m PUR cable 5 x 0.34 mm ² with 5-pin sensor-actuator male connector (M12), IEC 61076-2-101, IEC 60947-2, min. tightening torque 0.9 Nm		
Enclosure rating	IP65/67		
Dimensions	Small plastic housing (ABS): 65 mm x 35 mm x 20 mm		
Weight	Approx. 55 g with cable		

Table 8: Technical data for TMM55E-PMHxxx

¹ All specified angular accuracies apply after a run-in time of 10 min at 25 °C

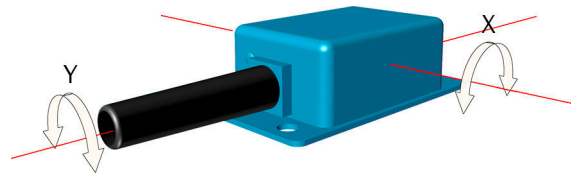

Figure 13: Measuring axes TMM55E

4.9 Technical data for TMM55E-POHxxx

General parameters ¹⁾	TMM55E-POH010	TMM55E-POH045	TMM55E-POH060
Number of measuring axes	2	2	2
Measuring range	±10°	±45°	±60°
Resolution (zero point)	0.01°	0.05°	0.06°
Angle deviations, max. (in measuring range)	±0.15°	±0.30°	±0.50°
Cross sensitivity	Typ. ±0.25° (±2.5%FS) Max. ±0.5° (±5%FS)	Typ. ±0.9° (±2.0%FS) Max. ±1.8° (±4.0%FS)	Typ. ±1.2° (±2.0%FS) Max. ±2.4° (±4.0%FS)
Temperature coefficient (zero point)	Max. ±0.009 °/K (in relation to the reference temperature 25 °C)		
Limit frequency	Typ. 18 Hz		
Operating temperature	-40 °C to +80 °C		

Table 9: Technical data for TMM55E-POHxxx

General parameters ¹⁾	TMM55E-POH010	TMM55E-POH045	TMM55E-POH060
Properties			
Interface	Voltage output 0 V ... 10 V, sinusoidal		
Calculation formula for angle value [°]	$\alpha = \arcsin\left[\frac{U_{out} - 5V}{5V} * \sin(\text{maxvalue})\right]$		
Electrical parameters			
Supply voltage	11 ... 30 VDC		
Current consumption	15 mA .. 25 mA		
Mechanical parameters			
Connection	0.2 m PUR cable 5 x 0.34 mm ² with 5-pin sensor-actuator male connector (M12), IEC 61076-2-101, IEC 60947-2, min. tightening torque 0.9 Nm		
Enclosure rating	IP65/67		
Dimensions	Small plastic housing (ABS): 65 mm x 35 mm x 20 mm		
Weight	Approx. 55 g with cable		

Table 9: Technical data for TMM55E-POHxxx

¹⁾ All specified angular accuracies apply after a run-in time of 10 min at 25 °C

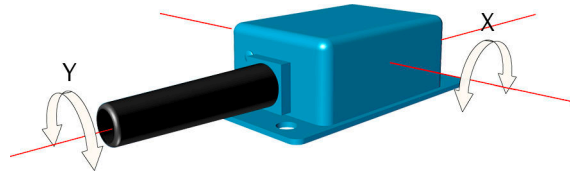

Figure 14: Measuring axes TMM55E

5 Transport and storage

5.1 Transport

For your own safety, please read and observe the following notes:



NOTE

Damage to the device due to improper transport.

- The device must be packaged for transport with protection against shock and damp.
- Recommendation: Use the original packaging as it provides the best protection.
- Transport should be performed by trained specialist staff only.
- The utmost care and attention is required at all times during unloading and transportation on company premises.
- Note the symbols on the packaging.
- Do not remove packaging until immediately before you start mounting.

5.2 Transport inspection

Immediately upon receipt in Goods-in, check the delivery for completeness and for any damage that may have occurred in transit. In the case of transit damage that is visible externally, proceed as follows:

- Do not accept the delivery or only do so conditionally.
- Note the scope of damage on the transport documents or on the transport company's delivery note.
- File a complaint.



NOTE

Complaints regarding defects should be filed as soon as these are detected. Damage claims are only valid before the applicable complaint deadlines.

5.3 Storage

Store the device under the following conditions:

- Recommendation: Use the original packaging.
- Do not store outdoors.
- Store in a dry area that is protected from dust.
- So that any residual damp can evaporate, do not package in airtight containers.
- Do not expose to any aggressive substances.
- Protect from sunlight.
- Avoid mechanical shocks.
- For storage periods of longer than 3 months, check the general condition of all components and packaging on a regular basis.

6 Mounting

6.1 Layout of the fixing holes

In the case of both the plastic (figure 16, figure 15) and the aluminum (figure 17) housing, the four holes for screw-mounting the sensor are located in the baseplate of the inclination sensor.

(Dimensions in mm)

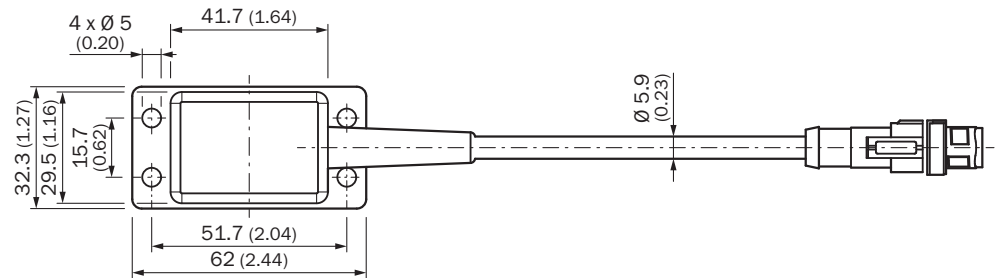

Figure 15: Dimensional drawing TMx55E

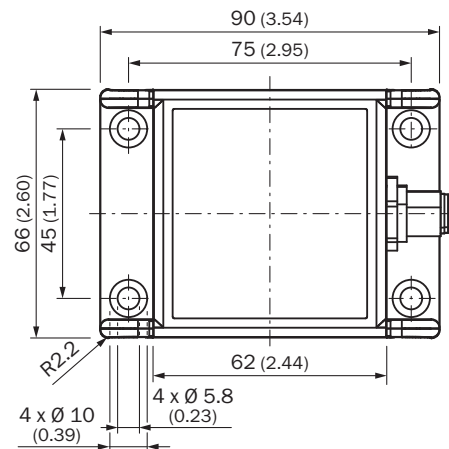

Figure 16: Dimensional drawing TMx88 (plastic housing)

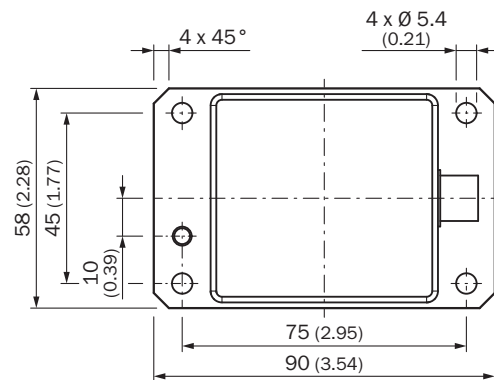

Figure 17: Dimensional drawing TMx88 (aluminum housing)

7 Connection

7.1 Pin assignment

TMx88

TMx88 inclination sensors are equipped with a standard 5-pin M12 round male connector (A-coded).

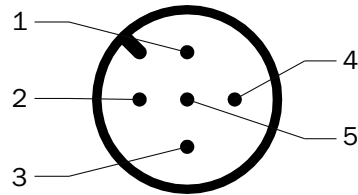

Pin	Signal	Pin assignment
1	V+	Supply voltage (+24 V)
2	B-OUT (standard Y)	Sensor output B
3	V- / GND	Supply voltage ground / sensor ground
4	A-OUT (standard X)	Sensor output A
5	TEACH	Input for zero-point setting

Table 10: M12 male connector pin assignment for TMx88

TMM55E

TMM55E inclination sensors are equipped with a cable 20 cm in length which features a standard 5-pin M12 round male connector (A-coded).

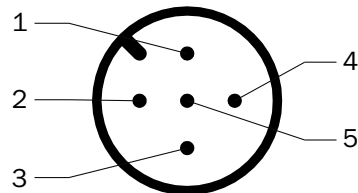

Pin	Wire color	Pin assignment
1	Brown	Supply voltage
2	White	Sensor signal Y axis (Y-OUT)
3	Blue	GND supply (V- / GND)
4	Black	Sensor signal X axis (X-OUT)
5	Green/yellow	Signal GND (connected to GND internally)

Table 11: M12 male connector pin assignment for TMM55E

7.2 Circuit diagram for TMx88

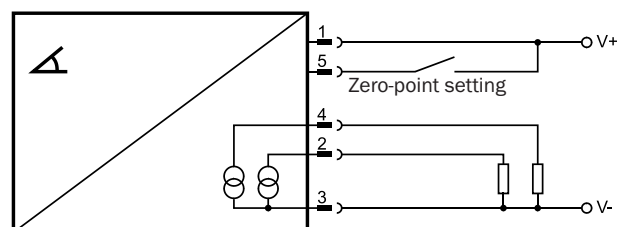

Figure 18: Circuit diagram for current output

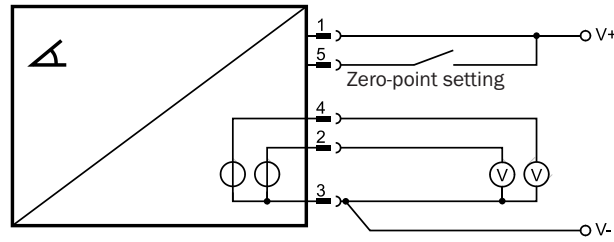

Figure 19: Circuit diagram for voltage output

7.3 Length of cable and minimum supply voltage for current output

For sensors with current output, the required supply voltage increases by the voltage dip on the connected cable. The most significant voltage dip on the cable occurs when the maximum current of 20 mA is flowing, caused by the resistance of the cable (R_L). The partial resistances of the go and return line must also be taken into account.

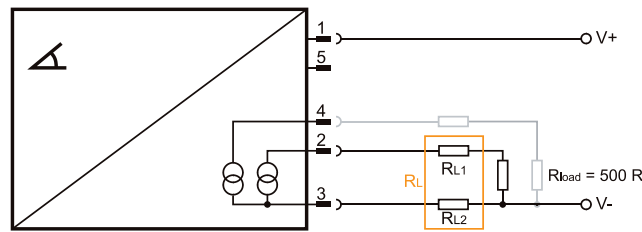

Figure 20: Length of cable for current output

The table lists example possible lengths of cables based on minimum operating voltage and corresponding cable cross-section. The table is based on cable resistances calculated to VDE 0295 and a load (R_{load}) of 500 Ω .

Minimum supply voltage in V	Cable resistance in Ω	Maximum length of cable in m with cable cross-section of:				
		0.14 mm ²	0.25 mm ²	0.34 mm ²	0.50 mm ²	0.75 mm ²
17	10	35	60	84	124	187
18	50	176	304	423	623	936
20	150	528	914	1271	1870	2808
22	250	880	1524	2118	3117	4681
24	350	1232	2134	2966	4364	6554
26	450	1584	2743	3813	5610	8426
28	550	1936	3353	4661	6857	10299
30	650	2288	3963	5508	8104	12172

Table 12: Lengths of cable with min. supply voltage and different cable cross-sections

7.4 Load resistances

The set load resistance essentially determines the power loss in the sensor, based on the supply voltage. To keep the power loss low and to avoid the sensor overheating, a load resistor appropriate for the supply voltage should be used. The following tables and diagrams illustrate the relationship between supply voltage and permissible load resistance for various operating temperatures.

The minimum and maximum load resistances specified below should always be understood as the total resistance at the output. This total resistance comprises the load resistance and the resistance of the cable.

7.4.1 Load resistance TMx55E

In the figure (see figure 21), the permissible load resistance based on the input voltage for the operating range up to 80 °C is shown in blue. Within a restricted operating range up to 65 °C, combinations of input voltage and load resistance from the area shown in gray are also permitted.



NOTE

For safety reasons, the sensor has an internal temperature shutdown feature. This switches off both of the sensor outputs as soon as the temperature in the sensor reaches a critical point because power loss is too high. Once the sensor has cooled down, both outputs switch back on automatically. If the cause of the increased power loss (usually an impermissible combination of supply voltage and load resistance) is not removed, the outputs will shut down again a short time later.

U _{dd} [V]	R _L min. [Ω] @ T _a max = 65 °C	R _L min. [Ω] @ T _a max = 80 °C	R _L max. [Ω]
11	0	150	290
12	0	200	330
24	600	800	930
30	900	1100	1230

Table 13: Minimum, typical, and maximum load resistances TMx55E

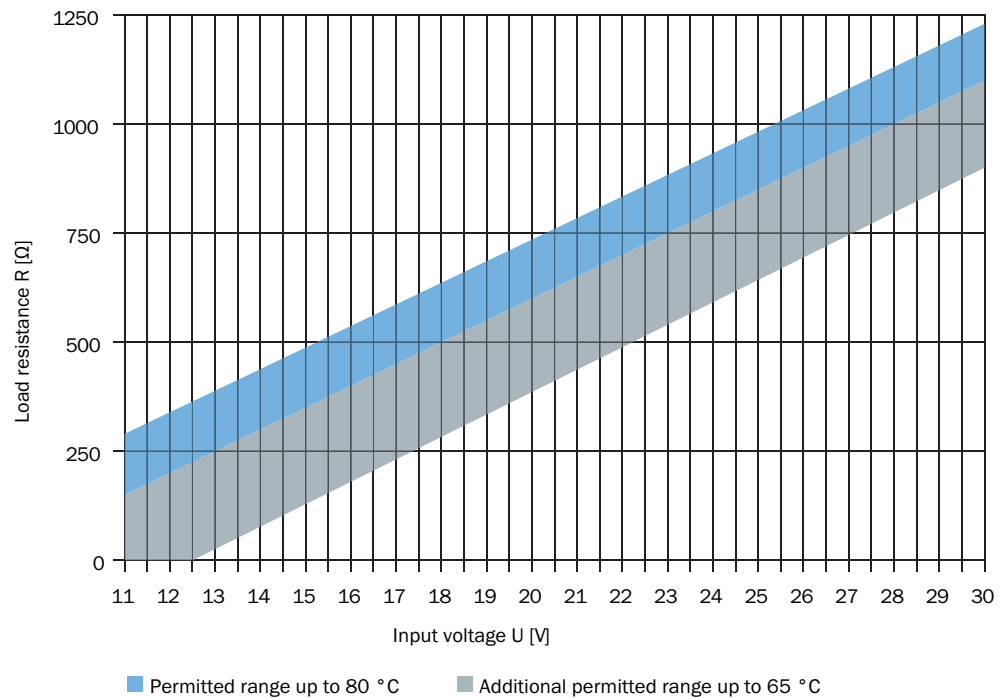

Figure 21: Permissible load resistances TMx55E

7.4.2 Load resistance TMx88A

In the figure (see figure 22), the permissible load resistance based on the input voltage for the operating range up to 80 °C is shown in blue. Within a restricted operating range up to 65 °C, combinations of input voltage and load resistance from the area shown in gray are also permitted.

U_{dd} [V]	R_L min. [Ω] @ $T_{a_{max}} = 65\text{ }^\circ\text{C}$	R_L min. [Ω] @ $T_{a_{max}} = 80\text{ }^\circ\text{C}$	R_L max. [Ω]
17	0	230	500
24	130	660	850
28	390	900	1050
35	830	1330	1410

Table 14: Minimum, typical, and maximum load resistances TMx88A

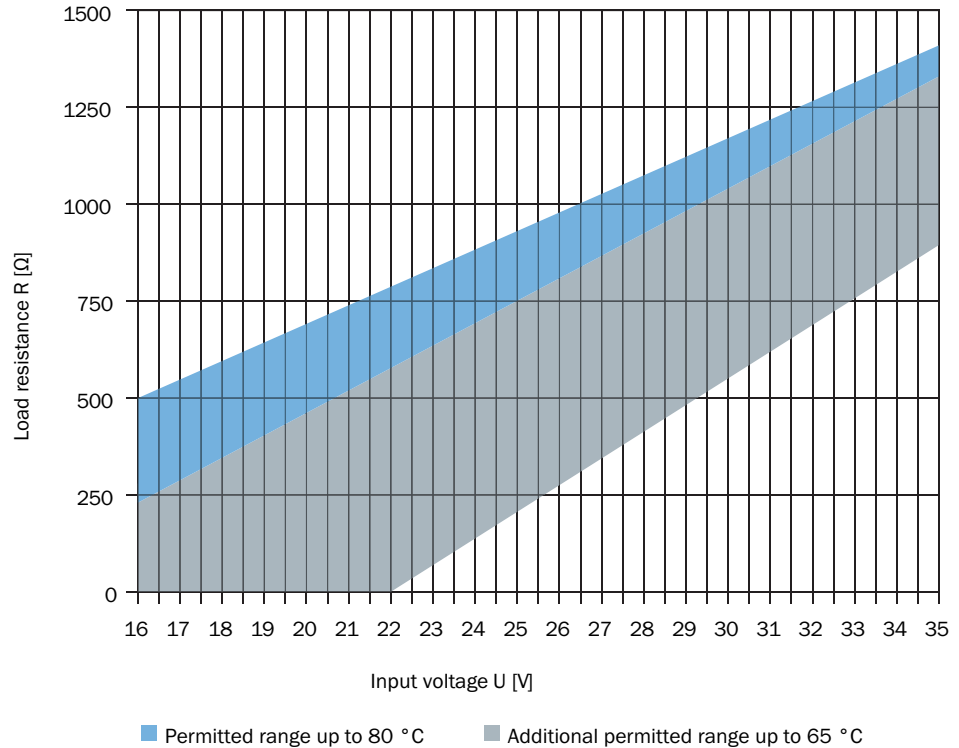

Figure 22: Permissible load resistances TMx88A

7.4.3 Load resistance TMx88B

In the figure (see figure 23), the permissible load resistance based on the input voltage for the operating range up to 80 °C is shown in blue. Within a restricted operating range up to 65 °C, combinations of input voltage and load resistance from the area shown in gray are also permitted.

U_{dd} [V]	R_L min. [Ω] @ $T_{a_{max}} = 65\text{ }^\circ\text{C}$	R_L min. [Ω] @ $T_{a_{max}} = 80\text{ }^\circ\text{C}$	R_L max. [Ω]
16	0	280	450
24	270	740	850
28	510	970	1050
35	930	1370	1400

Table 15: Minimum, typical, and maximum load resistances TMx88A

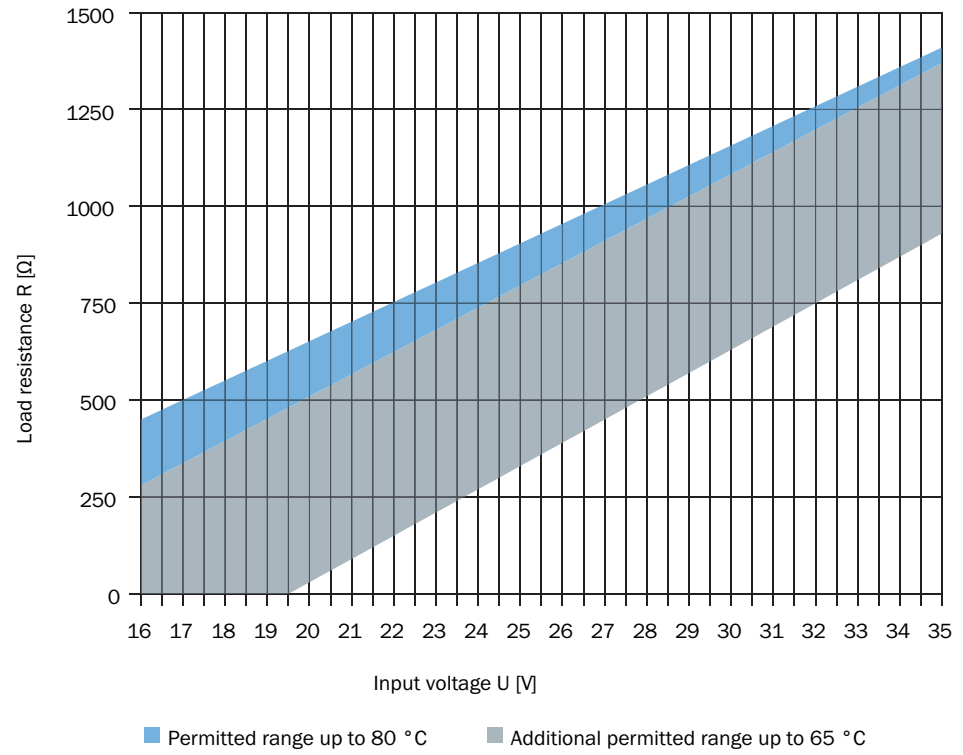

Figure 23: Permissible load resistances TMx88B

8 Description of operation TMM55

8.1 Calculating the inclination angle for TMM55E

Depending on type, TMM55E inclination sensors output an analog signal via the voltage interface or the current interface. The analog signal is sinusoidal. It is not linearized. Therefore, the angle value calculated by the sensor cannot be interpolated linear to the output signal. The actual inclination signal must be calculated separately in the controller. The following formulas are applied:

$$\alpha = \arcsin \left[\frac{I_{out} - 12 \text{ mA}}{8 \text{ mA}} * \sin(\text{maxvalue}) \right]$$

$$\alpha = \arcsin \left[\frac{U_{out} - 5 \text{ V}}{5 \text{ V}} * \sin(\text{maxvalue}) \right]$$

Example calculation

Sensor: TMM55E-PMH060

- Interface: 4 mA ... 20 mA, sinusoidal
- Measuring range: $\pm 60^\circ$

$$\alpha = \arcsin \left[\frac{I_{out} - 12 \text{ mA}}{8 \text{ mA}} * \sin(\text{maxvalue}) \right]$$

Assumption: $I_{out} = 18 \text{ mA}$

Inclination angle: α

$$\alpha = \arcsin \left[\frac{18 \text{ mA} - 12 \text{ mA}}{8 \text{ mA}} * \sin 60^\circ \right]$$

$$\alpha = \arcsin \left[\frac{6 \text{ mA}}{8 \text{ mA}} * 0,866 \right]$$

$$\alpha = \arcsin(0,6495)$$

$$\alpha = 40,51^\circ$$

9 Description of operation TMS/TMM88

9.1 Axis assignment/Reversal of counting direction

All inclination sensors with current or voltage output have 2 analog outputs A and B. These outputs can be assigned at will to the inclination axes X and Y for the 2-dimensional inclination sensor and to the axis of rotation in the case of the 1-dimensional inclination sensor (the axes are available in the hardware). Both inputs can even be assigned to the same axis. Since the direction can be reversed, any conceivable output assignment is possible. This is done by swapping the output values for current or voltage.

9.2 Zero-point setting

The zero point can be configured for all inclination sensors with current or voltage output. This means that it is possible to specify the zero position when the sensor is installed. The setting can be made either with the PGT-12-Pro hand-held programming tool or using the teach input. The teach input must be connected to the supply voltage (V+, pin 1) for at least one second if you wish to use it to set the zero point. The current angle of the inclination sensor is then set to 0 angular degrees for both outputs. The sensor acknowledges the setting of the zero point by switching off the status LED, also for one second. To reset the zero point to the factory setting, the teach input must be connected to the supply voltage for a further three seconds. The sensor acknowledges the reset by switching off the status LED, also for three seconds.

9.3 Digital filters

Tmx88 inclination sensors support an option to make the angle value more insensitive to external vibration interference. Oscillation/vibration interference up to 0.1 Hz can be suppressed with the configurable 8th order low-pass filter. The sensor has two digital filters which can be selected according to the area of application in which the sensor is being used.

Filter	Configurable frequency range	Areas of application
Butterworth	0.1 Hz ... 25 Hz	Static inclination measurement with high damping against vibrations
Critically damped	0.1 Hz ... 8 Hz	Inclination measurement for applications subject to specific dynamics, without overshoot in the event of changes in angle combined with good damping

Table 16: Filter selection

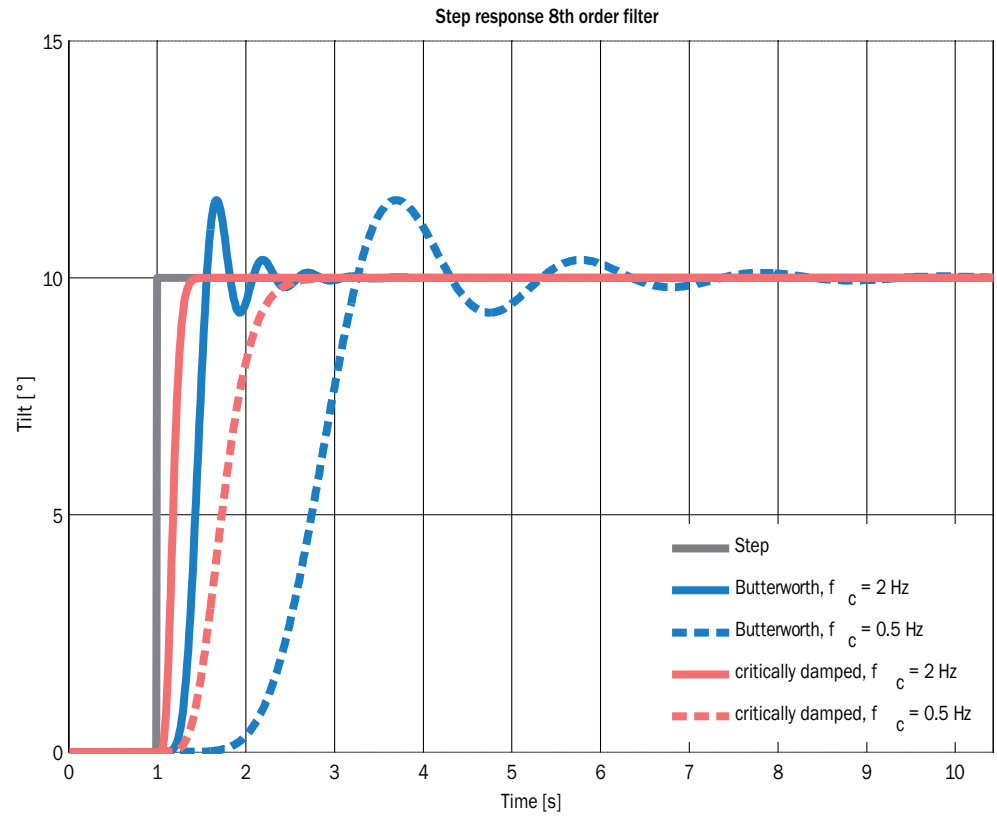

Figure 24: Pulse response of both filters

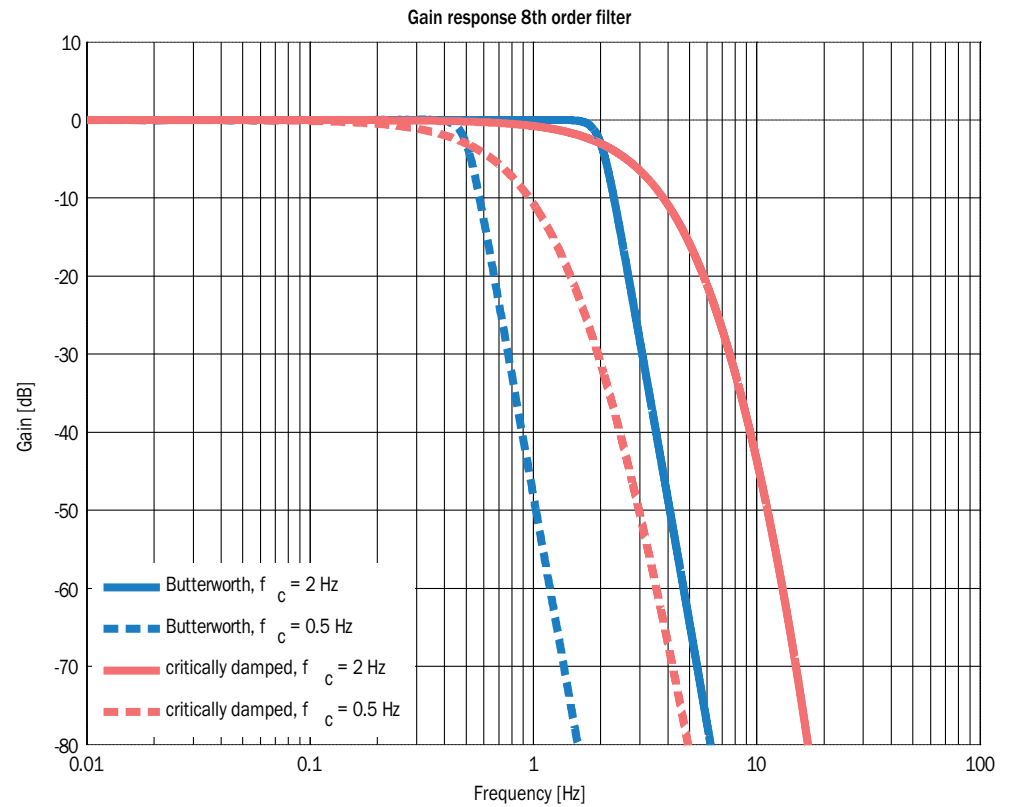

Figure 25: Amplitude characteristic of both filters

9.4 Status LED

The integrated status LED indicates the current status of the device. The statuses listed in the following table can be identified based on the color of the associated LEDs.

Status LED	Description
Off	No power supply available or teach confirmation
Green	The device is in the normal operating status
Red	Current interface: one or both inputs in the idle state (no load) or connected incorrectly Voltage interface: one or both inputs short-circuited or connected incorrectly

Table 17: Status and error information indicated by the status LED

Australia

Phone +61 3 9457 0600
1800 334 802 – tollfree
E-Mail sales@sick.com.au

Austria

Phone +43 (0)22 36 62 28 8-0
E-Mail office@sick.at

Belgium/Luxembourg

Phone +32 (0)2 466 55 66
E-Mail info@sick.be

Brazil

Phone +55 11 3215-4900
E-Mail marketing@sick.com.br

Canada

Phone +1 905 771 14 44
E-Mail information@sick.com

Czech Republic

Phone +420 2 57 91 18 50
E-Mail sick@sick.cz

Chile

Phone +56 2 2274 7430
E-Mail info@schadler.com

China

Phone +86 4000 121 000
E-Mail info.china@sick.net.cn

Denmark

Phone +45 45 82 64 00
E-Mail sick@sick.dk

Finland

Phone +358-9-2515 800
E-Mail sick@sick.fi

France

Phone +33 1 64 62 35 00
E-Mail info@sick.fr

Germany

Phone +49 211 5301-301
E-Mail info@sick.de

Great Britain

Phone +44 (0)1727 831121
E-Mail info@sick.co.uk

Hong Kong

Phone +852 2153 6300
E-Mail ghk@sick.com.hk

Hungary

Phone +36 1 371 2680
E-Mail office@sick.hu

India

Phone +91-22-4033 8333
E-Mail info@sick-india.com

Israel

Phone +972-4-6881000
E-Mail info@sick-sensors.com

Italy

Phone +39 02 27 43 41
E-Mail info@sick.it

Japan

Phone +81 (0)3 5309 2112
E-Mail support@sick.jp

Malaysia

Phone +603 808070425
E-Mail enquiry.my@sick.com

Netherlands

Phone +31 (0)30 229 25 44
E-Mail info@sick.nl

New Zealand

Phone +64 9 415 0459
0800 222 278 – tollfree
E-Mail sales@sick.co.nz

Norway

Phone +47 67 81 50 00
E-Mail sick@sick.no

Poland

Phone +48 22 837 40 50
E-Mail info@sick.pl

Romania

Phone +40 356 171 120
E-Mail office@sick.ro

Russia

Phone +7-495-775-05-30
E-Mail info@sick.ru

Singapore

Phone +65 6744 3732
E-Mail sales.gsg@sick.com

Slovakia

Phone +421 482 901201
E-Mail mail@sick-sk.sk

Slovenia

Phone +386 (0)1-47 69 990
E-Mail office@sick.si

South Africa

Phone +27 11 472 3733
E-Mail info@sickautomation.co.za

South Korea

Phone +82 2 786 6321
E-Mail info@sickkorea.net

Spain

Phone +34 93 480 31 00
E-Mail info@sick.es

Sweden

Phone +46 10 110 10 00
E-Mail info@sick.se

Switzerland

Phone +41 41 619 29 39
E-Mail contact@sick.ch

Taiwan

Phone +886 2 2375-6288
E-Mail sales@sick.com.tw

Thailand

Phone +66 2645 0009
E-Mail tawiwat@sicksgp.com.sg

Turkey

Phone +90 (216) 528 50 00
E-Mail info@sick.com.tr

United Arab Emirates

Phone +971 (0) 4 88 65 878
E-Mail info@sick.ae

USA/Mexico

Phone +1(952) 941-6780
1 (800) 325-7425 – tollfree
E-Mail info@sick.com

Vietnam

Phone +84 8 62920204
E-Mail Ngo.Duy.Linh@sicksgp.com.sg

More representatives and agencies
at www.sick.com