

Connection elements

ANS top
ANS bottom

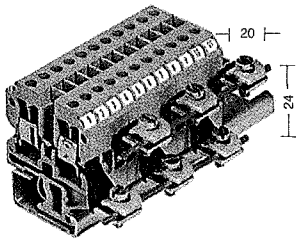

Connection for N and earth conductors for use with Type SAK 2.5 to SAK 10 terminal blocks.

Type	Cat.No.	Qty.
ANS (top)	027240	50
ANS (bottom)	027250	50

Connection data:

Screw connection, solid 4...16 mm²

The connectors are fitted with wire clamps according to DIN 46288.

In order to maintain the rated values, the connection elements must be offset.

AK 95

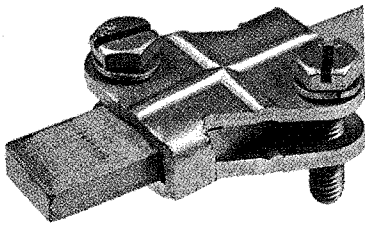

The AK 95 connection element is used as a clamping yoke for the 15 x 6 busbars (see page 3/15).

Type	Cat.No.	Qty.
AK 95	036420	10

for 15 x 6 busbar

Connection cross-section

e = 6...16 mm²

f = 6...50 mm²

m = 16...50 mm²

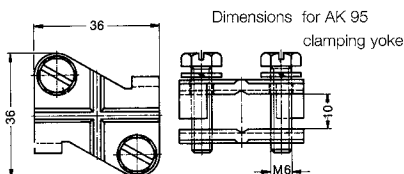

Dimensions for AK 95 clamping yoke

KLBÜ

KLBÜ 3-8

KLBÜ 4-13.5

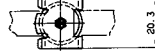
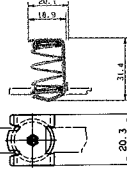
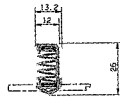

KLBÜ 10-20

KLBÜ 2 x 2-6

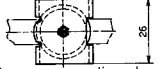
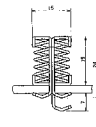
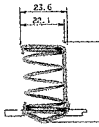

Screen connection element for subsequent positioning on a 10 x 3 mm busbar.

Type	Cat.No.	Qty.
KLBÜ 3-8	160048	10
KLBÜ 4-13.5	159281	10
KLBÜ 10-20	160049	10
KLBÜ 2 x 2-6	167535	10

Connection data

Cable diameter (mm Ø)

KLBÜ 3-8	3...8
KLBÜ 4-13.5	4...13.5
KLBÜ 10-20	10...20
KLBÜ 2 x 2-6	2...6

WSH

WSH 1 support block for KLBÜ 4-13.5 or KLBÜ 10-20.

Width 8 mm

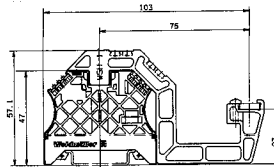

WSH 2 support block for KLBÜ 3-8 and KLBÜ 2 x 2-6

Width 5 mm

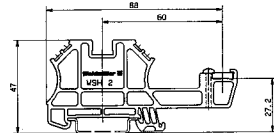

WSH 2/ZA Double support block for KLBÜ 3-8 and KLBÜ 2 x 2-6

Width 5 mm

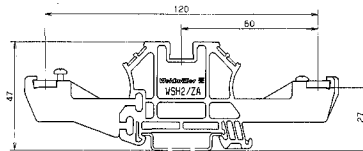

Type	Cat.No.	Qty.
WSH 1	106870	10
WSH 2	106880	10
WSH 2/ZA	107140	10

Clamping yoke

In order to connect N or earth conductors at a central location, it is advantageous to use The ZB clamping yoke together with the 10 x 13 busbars. The clamping yokes can be moved on the busbar and, therefore, adapted to the installation wiring. For use as protective earth connectors, clamping yokes are available with green/yellow insulation hoods. These hoods emphasise the function of the earth conductor and, with the aid of marking tags, enable the respective earth conductors to be clearly arranged.

If the clamping yokes are used to connect neutral conductors they can be marked with blue insulation hoods. The ZBE 6 can also be retro-fitted.

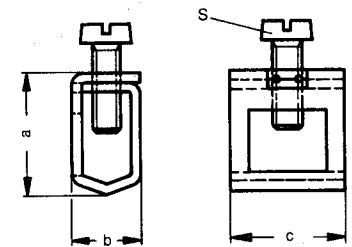
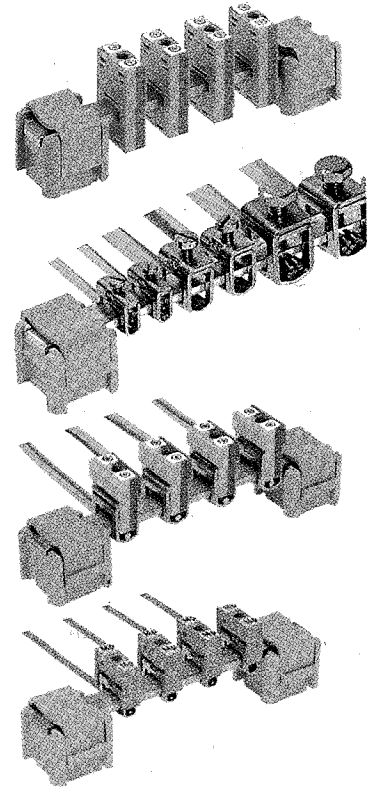

Dimensions for clamping yokes with insulation hoods

