



Think Automation and beyond...

ø22mm HW1Z

Illuminated / Non-Illuminated Buzzer



IDEC CORPORATION

Solution example ① Waterproof equipment

A buzzer is installed to detect errors but a waterproof buzzer is required when touched with wet hands.

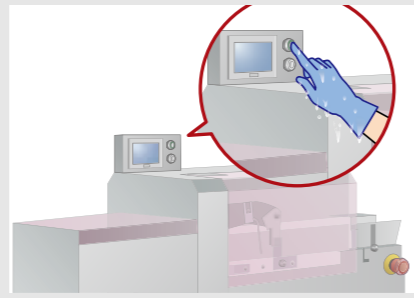

IDEC HW1Z series are

IP65 waterproof from the front of the panel

Ideal for equipment requiring washdown.



Application examples

- Food and packaging
- Weigh scales



Solution example ② Waterproof / Dustproof

The buzzer must be installed in a control box to be protected from water and dust.



IDEC HW1Z series have

waterproof construction

Installing an optional terminal rubber boot upgrades the terminal's waterproof characteristics to IP54 without the need to use a rear enclosure.



Application examples

- Semi-outdoor (station platform, parking lot)
- Elevators



Solution example ③ Downsizing of Equipment / Panels

The depth of conventional buzzers are too long to mount into slim panels.



IDEC HW1Z enables

downsizing of panels / equipment

Short, 19.7 mm depth behind panel.
Can be installed in tight places.



Application examples

- Machine tools
- Semiconductor
- Food and packaging



Solution example ④ Safety measures in factories

Safety measures are required on moving equipment such as AGVs and forklifts.



IDEC HW1Z have

push-in terminals

Push-in terminals allow easy wiring.
No tightening of screw is required.



Application examples

- Material handling (AGV, forklift)



Solution example ⑤ Locate equipment error

Buzzer sounds to alert an error but the production line has too many equipment making it difficult to locate the place of error.

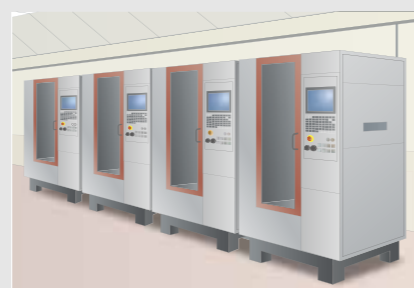

IDEC HW1Z series can

alert danger with sound and light

Lamp and buzzer functions are integrated.
Note) Illuminated buzzers only.

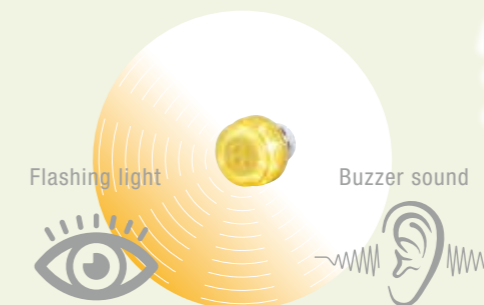

Application examples

- Semiconductor
- Production line



Accessories

Shape	Material	Part No. (Ordering No.)	Package Quantity	Notes
Terminal Rubber Boot 	Nitril Rubber	HW9Z-CZ1	1	Applicable cable: ø4.5 to 8.5 mm Cut the end of rubber boot to fit the cable size (see dimensions). Weight: 10 g (approx.)

Installing the terminal rubber boot

1. Cut the end of terminal rubber boot to fit the cable size.
2. Insert the cable into the terminal rubber boot in the direction of arrow shown below.

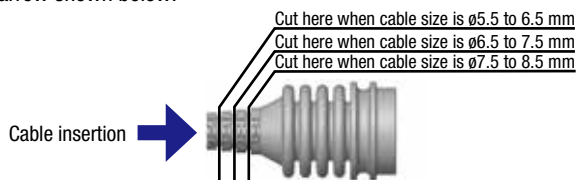

3. Strip the insulation of the cable 30 mm from the end and wire as instructed in "Wiring".
4. Install the terminal rubber boot as shown below.

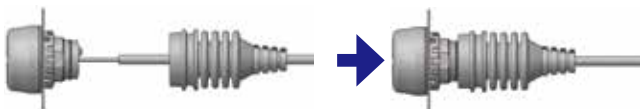

5. Cover part B with part A.



6. Make sure that the bellows is 17 to 22 mm long.

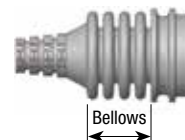

Note for terminal rubber boot

- Be sure to use bellows with an appropriate length. Otherwise, waterproof characteristics cannot be achieved.
- Maintain a cable angle of 45° maximum to the axis of the HW1Z, otherwise the terminal rubber boot may come off.

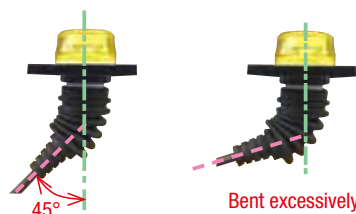

Transformer

Transformer	Primary Voltage	Operating Voltage Range	Part No. (Ordering No.)	Package Quantity	Buzzer
	100/110V AC	100/110V AC ±10%	TWR512	1	HW1Z-2PQ4B HW1Z-F2PQ4B
	200/220V AC	200/220V AC ±10%	TWR522	1	

- Terminal cover (TWR-VL3) is supplied as standard.
- Sound and sound volume differs when used at DC voltage.

Specifications



Part No.	TWR5□2
Operating Voltage	100/110V AC, 200/220V AC (50/60Hz)
Current Draw	2.4VA
Rated Insulation Voltage	600V
Insulation Resistance	100 MΩ minimum (500V DC megger)
Operating Temperature	-30 to +60°C (no freezing)
Storage Temperature	-40 to +80°C (no freezing)
Operating Humidity	35 to 85% RH (no condensation)
Vibration Resistance	Damage Limits: 30 Hz, amplitude 1.5 mm Operating extremes: 5 to 55 Hz, amplitude 0.5 mm
Shock Resistance	Damage limits: 1,000 m/s ² Operating Extremes: 100 m/s ²
Dielectric Strength	2,500V AC, 1 minute
Terminal Screw	M3.5
Applicable Wire	2 mm ² maximum, 2 wires maximum
Weight (approx.)	87g

Dimensions

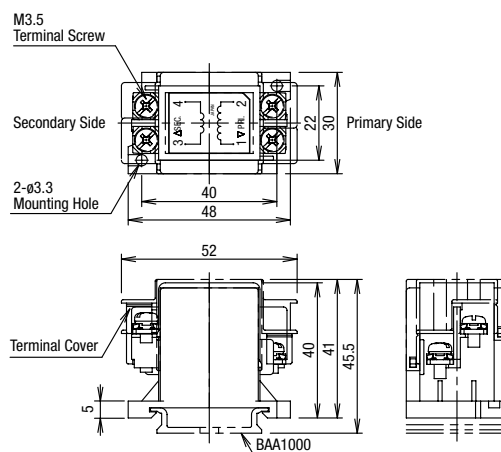
All dimensions in mm.



ø22mm HW1Z Illuminated / Non-Illuminated Buzzer

Shape	Part No. (Ordering No.)	Illumination Color	Sound	Package Quantity
	HW1Z-P1F2PQ4R	Red	Intermittent	1
	HW1Z-P1F2PQ4Y	Yellow		
	HW1Z-2PQ4B	—	Steady	1
	HW1Z-F2PQ4B	—	Intermittent	



• See website for details on approvals and standards.

Specifications

Specifications and Ratings

Rated Insulation Voltage	30V	
Rated Voltage	12 to 24V DC	
Voltage Range	10.8 to 26.4V DC	
Rated Current (effective value)	Illuminated: 18mA (24V DC), 8mA (12V DC) Non-Illuminated (Steady sound): 9mA (24V DC), 4mA (12V DC) (Intermittent sound): 7mA (24V DC), 3mA (12V DC)	
Inrush Current	100mA maximum	
Buzzer	Sound Volume (of HW1Z itself) (at 25°C)	90dB min. at 0.1m (24VDC) 70dB min. at 1m (24V DC, equivalent value)
	Sound Frequency (at 25°C)	84dB min. at 0.1m (12V DC) 64dB min. at 1m (12VDC, equivalent value)
	Sound Type	Illuminated: Intermittent Non-Illuminated: Steady/Intermittent
	Intermittent Cycle (at 25°C)	105 cycles/minute approx. (1.75Hz approx.)
Illumination	Illumination Type	Flashing
	Flash Cycle (at 25°C)	105 cycles/minute approx. (1.75Hz approx.)
Operating Temperature	-20 to +50°C (no freezing)	
Operating Humidity	20% to 85% RH (no condensation)	
Storage Temperature	-30 to +80°C (no freezing)	
Insulation Resistance	100MΩ minimum (at 500V DC megger)	
Dielectric Strength	Between live and earthed metal parts: 1000V AC, 1 minute	
Vibration Resistance	Operation extremes: 5 to 55Hz, amplitude 0.5mm Damage limits: 5 to 55Hz, amplitude 0.5mm	
Shock Resistance	Operation extremes: 100 m/s ² Damage limits: 1,000 m/s ²	
Degree of Protection	Panel front: IP65 (IEC 60529) Terminal: IP40 (IEC 60529) IP54 (with terminal rubber boot) (IEC 60529)	
Terminal Style	Push-in Terminals	
Applicable Wire	Solid wire/ferrule (without sleeve): 0.2 to 1.5 mm ² Ferrule (with sleeve): 0.2 to 0.75 mm ²	
Weight (approx.)	17g	

Dimensions

All dimensions in mm.

Buzzer only

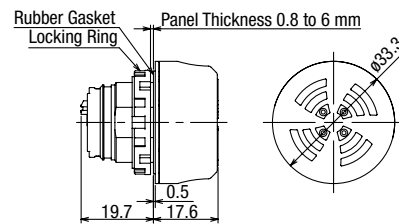

With terminal rubber boot

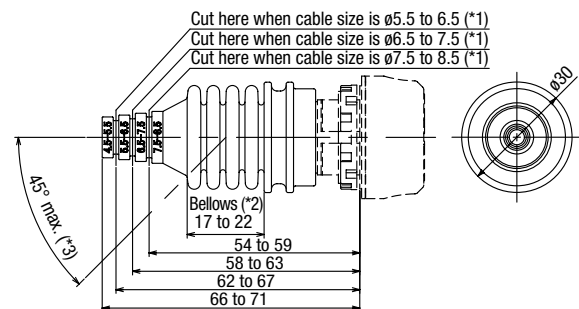

*1: ø4.5-5.5 cable needs no cutting.

*2: The bellows must be 17 to 22mm long after installing the terminal rubber boot.

*3: Maintain a cable angle of 45° max. to the HW1Z axis.

Terminal Arrangement (bottom view)

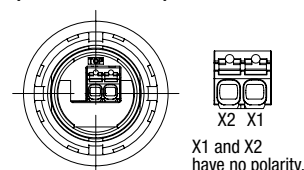

Mounting Hole Layout

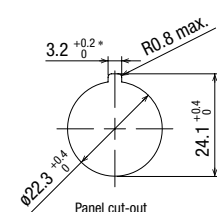

*3.2 +0.2/0 hole is for anti-rotation.
Not required when nameplate/anti-rotation is not used.

⚠ Safety Precautions

- Turn off the power to the HW1Z before installation, removal, wiring, maintenance, and inspection. Failure to turn power off may cause electrical shocks or fire hazard.
- For wiring, use wires of a proper gauge to meet the voltage and current requirements.
- Prevent metal fragments and pieces of wire from dropping inside when installing or wiring the HW1Z. Otherwise fire, failure, or malfunction may be caused.

Operating Instructions

Panel Mounting

- Insert the HW1Z into the panel cut-out from the front, and tighten the locking ring from the back.

Note for panel mounting

- Use the optional locking ring wrench (MW9Z-T1) to tighten the locking ring to a recommended tightening torque of 1.5 to 2.0 N-m.
- Do not use pliers and do not tighten excessively, otherwise the HW1Z may be damaged.

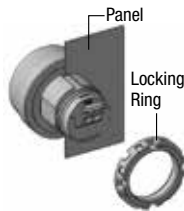

Wiring

Solid wire

Strip the wire insulation 8 mm from the end and insert into the terminal. Make sure that the wire does not loosen.

Stranded wire with ferrule

Clamp a ferrule with a conductor wire length of 8mm and insert into the terminal. Make sure that the wire does not loosen.

Recommended Ferrules

Phoenix Contact

Without sleeve	With sleeve
For 0.5mm ² : A0,5-8	For 0.25mm ² : A10,25-8YE
For 0.75mm ² : A0,75-8	For 0.5mm ² : A10,5-8WH
For 1.0mm ² : A1-8	For 0.75mm ² : A10,75-8GY

Stranded wire

Strip the wire insulation 8mm from the end and push in the wire removal part above the wire port using a small flat screwdriver. Release the wire removal part. Make sure that the wire does not loosen.

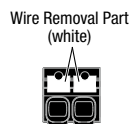

Wire removal

Push in the white wire removal part above the wire ports using a small flat screw driver, and pull out the wire.

Small flat screwdriver

Use a screwdriver (flat, 2.5mm-wide blade).

Note for wiring

- Make sure that the terminal is not constantly pulled by the wire.
- Wiring must be performed in environments of -5 to +50°C.
- Do not damage the conductor wire when stripping the wire insulation.
- Do not use wires with bent or deformed conductors wires. Deformed wiring may cause failures such as strength degradation and overheating.
- Connect one wire per terminal. Connecting two wires to a terminal may cause loose wiring and strength degradation.
- Do not solder the conductor lines. Connecting soldered stranded wires may cause loose wiring and strength degradation.
- If a stranded wire has loose wires, twist the conductor wires before connection. However be careful not to twist too much.

Operating Conditions

Do not use the HW1Z in the following locations.

- Exposure to direct sunlight
- Subject to corrosive or flammable gases

IDEC CORPORATION

Head Office

6-64, Nishi-Miyahara-2-Chome, Yodogawa-ku, Osaka 532-0004, Japan

USA	IDEC Corporation	Tel: +1-408-747-0550	opencontact@idec.com	Hong Kong	IDEC Izumi (H.K.) Co., Ltd.	Tel: +852-2803-8989	info@hk.idec.com
Germany	APEM GmbH	Tel: +49-40-25 30 54 - 0	service@eu.idec.com	China/Shanghai	IDEC (Shanghai) Corporation	Tel: +86-21-6135-1515	idec@cn.idec.com
Singapore	IDEC Izumi Asia Pte. Ltd.	Tel: +65-6746-1155	info@sg.idec.com	China/Shenzhen	IDEC (Shenzhen) Corporation	Tel: +86-755-8356-2977	idec@cn.idec.com
Thailand	IDEC Asia (Thailand) Co., Ltd.	Tel: +66-2-392-9765	sales@th.idec.com	China/Beijing	IDEC (Beijing) Corporation	Tel: +86-10-6581-6131	idec@cn.idec.com
Australia	IDEC Australia Pty. Ltd.	Tel: +61-3-8523-5900	sales@au.idec.com	Japan	IDEC Corporation	Tel: +81-6-6398-2527	marketing@idec.co.jp
Taiwan	IDEC Taiwan Corporation	Tel: +886-2-2698-3929	service@tw.idec.com				

 www.idec.com

Specifications and other descriptions in this brochure are subject to change without notice.
Information in this brochure is current as of August 2019.
2019 IDEC Corporation, All Rights Reserved.

