

- > Port size: 3/8" ... 3/4" (ISO G/PTF)
- > Excelon design allows in-line installation or modular installation with other Excelon products
- > T74B 2/2 valves no exhaust
- > T74T 3/2 valves with 1/8" tapped exhaust
- > T74E 3/2 position lockout valves help conform to OSHA Lockout regulations in USA market. Exhaust outlet is not tapped.



Technical features

Medium:

Compressed air only

Maximum operating pressure:

17 bar (250 psi)

Port size:

G3/8, G1/2, G3/4,
3/8 PTF 1/2 PTF , 3/8 PTF

CV factor:

From IN to OUT ports:

3/8": 7,1; 1/2": 8,1; 3/4": 7,7

0,2 from OUT to Exhaust ports on 3/2 valves

Ambient/Media temperature:

-34° ... +65°C (-30° ... +149°F)

Air supply must be dry enough to avoid ice formation at temperatures below +2°C (+35°F).

Materials:

Body: Zinc

Elastomers: NBR

Technical data - standard models

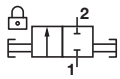
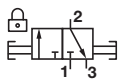
Symbol	Port size	Function	Size	Weight (kg)	Model
	G3/8	2/2	—	0,32	T74B-3GA-P1N
	G1/2	2/2	Basic	0,30	T74B-4GA-P1N
	G3/4	2/2	—	0,28	T74B-6GA-P1N
	G3/8	3/2	—	0,32	T74T-3GA-P1N
	G1/2	3/2	Basic	0,30	T74T-4GA-P1N
	G3/4	3/2	—	0,28	T74T-6GA-P1N





Option selector

T74★-★★A-P1N

Function	Substitute
2/2 (Black slide locks in closed position only) No exhaust ou let	B
3/2 (Yellow slide locks in closed position only) Unthreaded exhaust ou let	E
3/2 (Red slide locks in closed position only) Threaded exhaust port	T



Thread form	Substitute
NPT	A
ISO G parallel (standard)	G
Thread size	Substitute
3/8"	3
1/2"	4
3/4"	6

Accessories

Quikclamp®	Quikclamp with wall bracket®	Quikmount pipe adaptor *1)	Porting block with three alternative 1/4" ports	Silencer
				
Page 3	Page 3	Page 3	Page 3	Page 3
4314-51	4314-52	G3/8: 4315-10 G1/2: 4315-11 G3/4: 4315-12 3/8 PTF: 4315-02 1/2 PTF: 4315-03 3/4 PTF: 4315-04	G1/4: 4316-52 1/4 PTF: 4316-50	R1/8: T40B1800 1/8 NPT: MA001A

*1) Please use a Quikmount pipe adaptor if the Quikclamp be mounted at inlet or outlet side.

Pressure switch

Porting block for pressure switch	Pressure switch (0,5 ... 8 bar)	Padlock (brass) with two keys *1)
		
Page 4		
0523110000000000	0881300000000000	0613633000000000

*1) for shut-off valves

Service kits

Service kit
T74E (yellow slide) 4384-710
T74T (red slide) 4384-713

Service kit includes seals and slide.

Drawings

Dimensions in mm
Projection/First angle

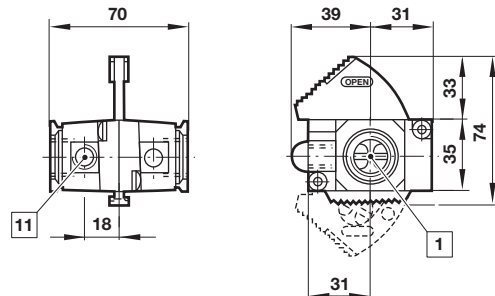

- 1 Main ports 3/8", 1/2" or 3/4" ISO G/PTF
- 11 Exhaust port Rc1/8 or 1/8 PTF

Accessories

 Dimensions in mm
 Projection/First angle

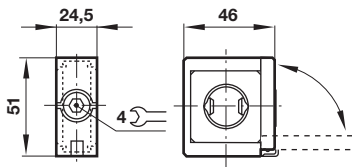
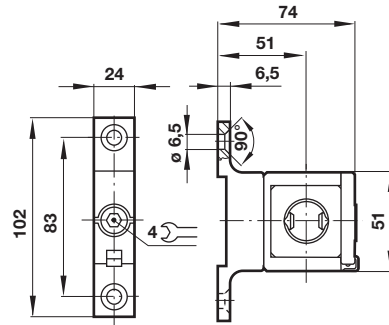
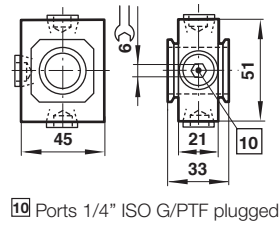
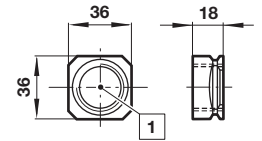
Quikclamp®

Quikclamp® with wall bracket

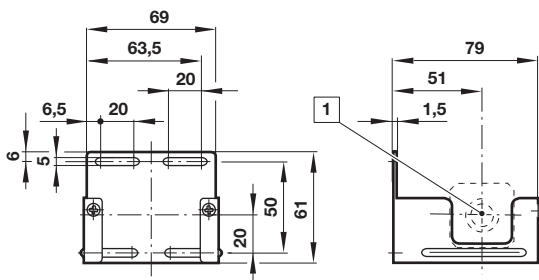
Porting block

Pipe adapter

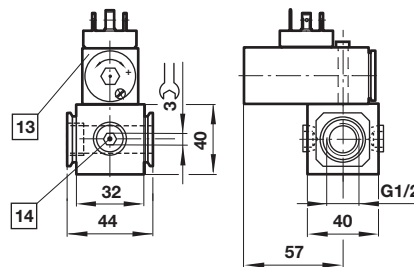
 1 Main ports 3/8", 1/2" or 3/4"
 ISO G/PTF

10 Ports 1/4" ISO G/PTF plugged

Wall mounting bracket

1 Main ports

Porting block for pressure switch

13 Pressure switch is not in scope of delivery

14 Alternative G1/4 ports plugged

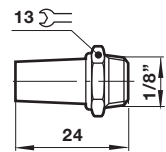
Silencer

Warning

These products are intended for use in industrial compressed air systems only. Do not use these products where pressures and temperatures can exceed those listed under

»Technical features/data«.

Before using these products with fluids other than those specified, for non-industrial applications, life-support systems or other applications not within published specifications, consult IMI NORGREN.

Through misuse, age, or malfunction, components used in fluid power systems can fail in various modes.

The system designer is warned to consider the failure modes of all component parts used in fluid power systems and to provide adequate safeguards to prevent personal injury or damage to equipment in the event of such failure.

System designers must provide a warning to end users in the system instructional manual if protection against a failure mode cannot be adequately provided.

System designers and end users are cautioned to review specific warnings found in instruction sheets packed and shipped with these products.