



BTL7-abcd-Mnnnn-f-lm

BTL7

Magnetostrictive linear position sensor Generation 7

a interface

A = Voltage output 0 ... 10 V
G = voltage output -10 ... 10 V

b Operating voltage

5 = 10 ... 30 V

c + d Interface characteristic 1 + 2

01 = 2 outputs, each 1 x rising/falling settable/
programmable

Mnnnn Nominal length (4-position)

M0500 = metric in mm
(M0050...M7620)

f Style

P = Profile

l Connection type

S = Connector
KA = Cable (PUR)

m Connection type characteristic 1

for connector:
32 = M16x0.75 connector with 8 pins
115 = M12x1 connector with 8 pins

for cable (length in meters):
02, 05, 10, 15, 20, 30

Magnetostrictive Sensors

BTL7 -P- Series - Analog voltage

BALLUFF

Basic features

Approval/Conformity	CE cULus EAC WEEE
Magnets, number (factory setting)	1
Magnets, number max.	cd ≠ 10: 1 cd = 10: 2

Electrical connection

Polarity reversal protected	Ub up to 36 V
Short-circuit protection	to GND and to 36 V DC

Electrical data

Current consumption max. at 24 V DC	150 mA
Inrush current	nnnn 1525: ≤ 500 mA/10 ms nnnn ≥ 1525: ≤ 500 mA/25 ms
Operating voltage Ub	10...30 VDC
Output current max.	5 mA
Output current max.	5 mA
Output signal adjustable	with software tool
Overvoltage protection	Ub up to 36 V
Switch-on delay max.	nnnn 1525: 600 ms nnnn ≥ 1525: 800 ms
Voltage-proof up to (GND to housing)	500 V AC

Environmental conditions

Ambient temperature	-40...85 °C
Cable temperature, fixed routing	I = KA: -40 °C ... 90 °C
Cable temperature, flexible routing	I = KA: -5 °C ... 90 °C
EN 55016-2-3, Radiation	For industrial and residential use
EN 60068-2-27, Continuous shock	150 g, 2 ms
EN 60068-2-27, Shock	150 g, 6 ms
EN 60068-2-6, Vibration	20 g, 10...2000 Hz
EN 61000-4-2, ESD	Severity Level 3
EN 61000-4-3, RFI	Severity Level 3
EN 61000-4-4, Burst	Severity Level 3
EN 61000-4-5, Surge	Severity Level 2
EN 61000-4-6, High-frequency fields	Severity Level 3
EN 61000-4-8 Magnetic fields	Severity Level 4
Relative Luftfeuchtigkeit	≤ 90 %, non-condensing
Schutzart	I = S: IP67 with connector I = KA: IP68
Storage temperature	-40...100 °C
Temperature coefficient typ.	≤ 30 ppm/K at 50% of nominal stroke 500mm

Functional safety

MTTF (40 °C)	72 a
--------------	------

Material

Cable flame-resistant	I = KA: IEC 60332-1
Cable jacket, material	I = KA: PUR
Cover material	Aluminum, Die-cast, nickel plated
Housing material	Aluminum, Anodized
Housing material, surface protection	Anodized

Mechanical data

Overall Length	nnnn + 145 mm
Speed detectable max.	10 m/s

Output/Interface

Interface	Analog, voltage
-----------	-----------------

Range/Distance

Linearity deviation	nnnn = 0050...0500: ± 50 µm nnnn = 0501...5500: ± 0.01% FS nnnn 5500: ± 0.02% FS
Measuring length	50...7620 mm
Repeat accuracy	± 10 µm
Sampling frequency max.	nnnn = 0050...0250: 4000 Hz nnnn = 0251...0600: 2000 Hz nnnn = 0601...1300: 1000 Hz nnnn = 1301...2700: 500 Hz nnnn = 2701...5500: 250 Hz nnnn 5500: 180 Hz

Magnetostrictive Sensors
BTL7 -P- Series - Analog voltage

BALLUFF

BTL7-A501-Mxxxx-P-S32

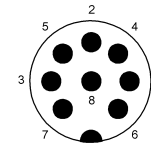
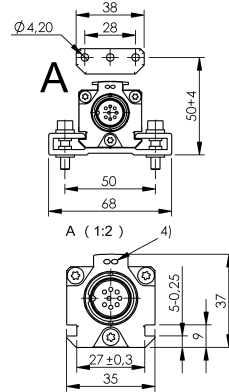
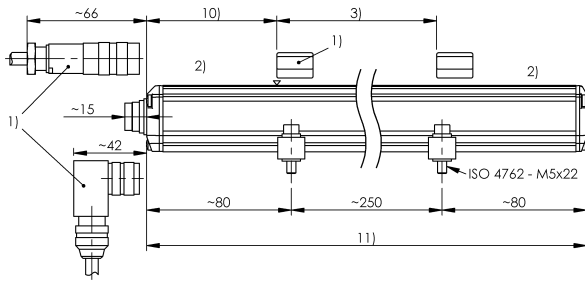

Pin	
1	NC
2	0V
3	10...0 V
4	La
5	0...10 V
6	GND
7	+24 V DC
8	Lb

- 1) not included in scope of delivery
- 2) Non-usable area
- 3) Nominal length = Measuring length
- 4) LED function indicator
- 10) Null point
- 11) Installation length

BTL7-G501-Mxxxx-P-S115

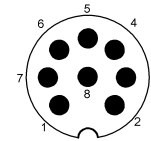
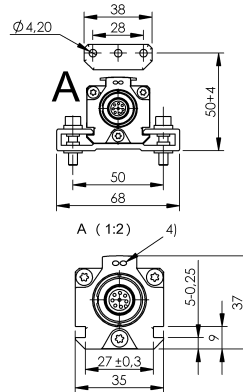
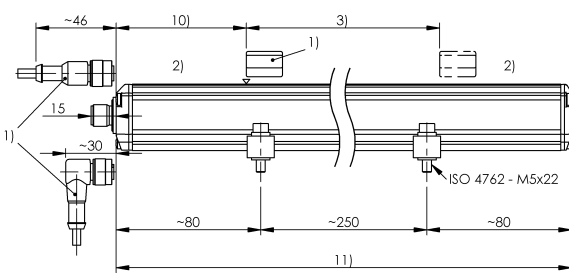

Pin	
1	0 V (Pin 3)
2	0 V (Pin 5)
3	10...-10 V
4	La
5	-10...10 V
6	GND
7	10...30 V DC
8	Lb

- 1) not included in scope of delivery
- 2) Non-usable area
- 3) Nominal length = Measuring length
- 4) LED function indicator
- 10) Null point
- 11) Installation length

Magnetostrictive Sensors
BTL7 -P- Series - Analog voltage

BALLUFF

BTL7-A501-Mxxxx-P-KAxx

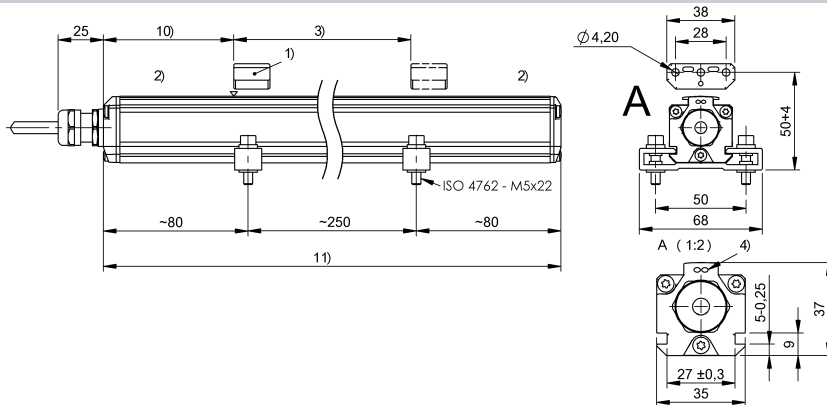

colour	
YE	NC
GY	0 V
PK	10...0 V
RD	La
GN	0...10 V
BU	GND
BN	+24 V DC
WH	Lb

- 1) not included in scope of delivery
- 2) Non-usable area
- 3) Nominal length = Measuring length
- 4) LED function indicator
- 10) Null point
- 11) Installation length