



■ Features :

- 2:1 wide input range
- Protections: Short circuit / Overload / Over voltage
- 1500VAC I/O isolation
- Built-in EMI filter, low ripple noise
- 100% full load burn-in test
- Fixed switching frequency at 83KHz
- Low cost
- High reliability
- 2 years warranty



SPECIFICATION

MODEL	SD-25A-5	SD-25B-5	SD-25C-5	SD-25A-12	SD-25B-12	SD-25C-12	SD-25A-24	SD-25B-24	SD-25C-24	
OUTPUT	DC VOLTAGE	5V			12V			24V		
	RATED CURRENT	5A			2.1A			1.1A		
	CURRENT RANGE	0 ~ 5A			0 ~ 2.1A			0 ~ 1.1A		
	RATED POWER	25W			25.2W			26.4W		
	RIPPLE & NOISE (max.) Note.2	100mVp-p			120mVp-p			150mVp-p		
	VOLTAGE ADJ. RANGE	4.5 ~ 5.5VDC			11 ~ 16VDC			23 ~ 30VDC		
	VOLTAGE TOLERANCE Note.3	±2.0%			±1.0%			±1.0%		
	LINE REGULATION	±0.5%			±0.3%			±0.2%		
	LOAD REGULATION	±0.5%			±0.3%			±0.2%		
SETUP, RISE, HOLD UP TIME	2.5s, 50ms, ----- at full load									
INPUT	VOLTAGE RANGE	A:9.2 ~ 18VDC		B:19 ~ 36VDC		C:36 ~ 72VDC				
	EFFICIENCY (Typ.)	71%	72%	74%	72%	75%	78%	75%	78%	81%
	DC CURRENT	3.2A/12V	1.6A/24V	0.8A/48V	3.2A/12V	1.6A/24V	0.8A/48V	3.2A/12V	1.6A/24V	0.8A/48V
PROTECTION	OVERLOAD	105 ~ 150% rated output power Protection type : Hiccup mode, recovers automatically after fault condition is removed								
	OVER VOLTAGE	5.75 ~ 6.75V/10% load			16.8 ~ 20V/10% load			31.5 ~ 37.5V/10% load		
ENVIRONMENT	WORKING TEMP.	-10 ~ +60°C (Refer to "Derating Curve")								
	WORKING HUMIDITY	20 ~ 90% RH non-condensing								
	STORAGE TEMP., HUMIDITY	-20 ~ +85°C, 10 ~ 95% RH								
	TEMP. COEFFICIENT	±0.03%/°C (0 ~ 50°C)								
	VIBRATION	10 ~ 500Hz, 2G 10min./1cycle, 60min. each along X, Y, Z axes								
SAFETY & EMC (Note 4)	SAFETY STANDARDS	Design refer to LVD								
	WITHSTAND VOLTAGE	I/P-O/P:1.5KVAC I/P-FG:2KVAC O/P-FG:0.5KVAC								
	ISOLATION RESISTANCE	I/P-O/P, I/P-FG, O/P-FG:100M Ohms / 500VDC / 25°C / 70% RH								
	EMC EMISSION	Compliance to EN55032 (CISPR32) Class B								
OTHERS	EMC IMMUNITY	Compliance to EN61000-4-2,3,4,6,8, EN55024,heavy industry level, criteria A								
	MTBF	374.3K hrs min.(SD-25A)		365.9K hrs min.(SD-25B)		377.5K Hrs min.(SD-25C)		MIL-HDBK-217F (25°C)		
	DIMENSION	99*97*36mm (L*W*H)								
NOTE	PACKING	0.38Kg; 45pcs/17.8Kg/0.9CUFT								
		1. All parameters NOT specially mentioned are measured at 12,24,48VDC input, rated load and 25°C of ambient temperature. 2. Ripple & noise are measured at 20MHz of bandwidth by using a 12" twisted pair-wire terminated with a 0.1uf & 47uf parallel capacitor. 3. Tolerance : includes set up tolerance, line regulation and load regulation. 4. The power supply is considered a component which will be installed into a final equipment. All the EMC tests are been executed by mounting the unit on a 360mm*360mm metal plate with 1mm of thickness. The final equipment must be re-confirmed that it still meets EMC directives. For guidance on how to perform these EMC tests, please refer to "EMI testing of component power supplies." (as available on http://www.meanwell.com)								

Mechanical Specification

Case No. 905 Unit:mm

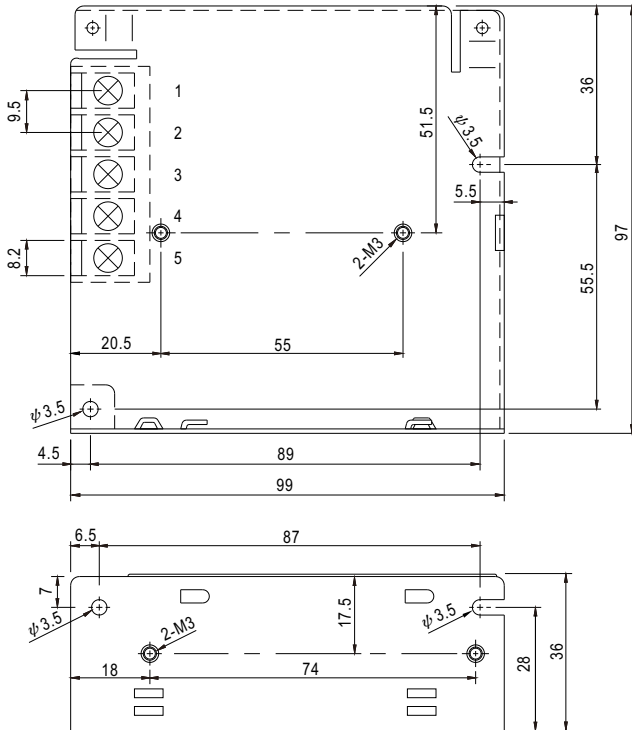

Terminal Pin No. Assignment

Pin No.	Assignment	Pin No.	Assignment
1	DC INPUT V-	4	DC OUTPUT +V
2	DC INPUT V+	5	DC OUTPUT -V
3	FG \pm		

Block Diagram

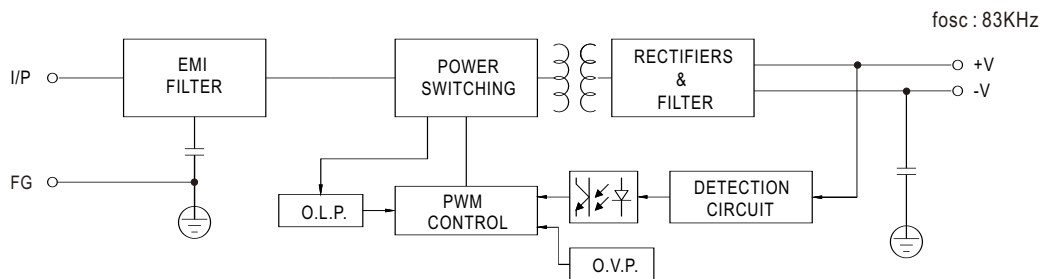

Derating Curve

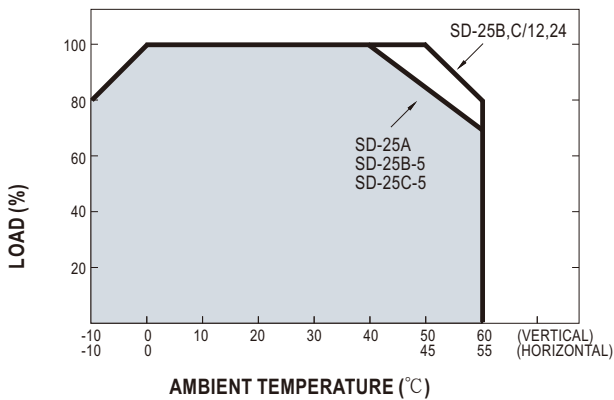

Static Characteristics(SD-25C-24V)

