



TIM310-1130000

TiM3xx

2D LIDAR SENSORS

SICK
Sensor Intelligence.



Ordering information

| Type | Part no. |
|----------------|----------|
| TIM310-1130000 | 1056550 |

Other models and accessories → www.sick.com/TiM3xx



Detailed technical data

Features

| | |
|------------------------------|---|
| Measurement principle | HDDM ⁺ |
| Application | Indoor |
| Light source | Infrared (850 nm) |
| Laser class | 1 (IEC 60825-1:2014) EN 60825-1:2014 |
| Aperture angle | Horizontal 270° |
| Scanning frequency | 15 Hz |
| Angular resolution | 1° |
| Working range | 0.05 m ... 4 m |
| Scanning range | At 10% remission 2 m |

Mechanics/electronics

| | |
|-------------------------------|---|
| Electrical connection | 1 x M12 12-pin male connector (0.8 m) |
| Supply voltage | 9 V DC ... 28 V DC |
| Power consumption | Typ. 4 W, 16 W with 4 max. loaded digital outputs |
| Housing color | Light blue (RAL 5012) |
| Enclosure rating | IP65 (IEC 60529:1989+AMD1:1999+AMD2:2013) |
| Protection class | III (IEC 61140:2016-1) |
| Weight | 150 g, without connecting cables |
| Dimensions (L x W x H) | 60 mm x 60 mm x 79 mm |

Performance

| | |
|--------------------------------|-----------------------|
| Response time | Typ. 67 ms |
| Detectable object shape | Almost any |
| Systematic error | ± 40 mm ¹⁾ |
| Statistical error | 30 mm ¹⁾ |

¹⁾ Typical value; actual value depends on environmental conditions.

| | |
|--------------------------------------|---|
| Integrated application | Field evaluation |
| Number of field sets | 16 field triples (48 fields, 1 triple (3 fields) can be configured directly at the scanner) |
| Simultaneous evaluation cases | 1 (3 fields) |

¹⁾ Typical value; actual value depends on environmental conditions.

Interfaces

| | |
|---------------------------|--|
| USB | ✓ |
| Remark | Micro USB |
| Function | AUX, parameterization |
| Digital inputs | 4 |
| Digital outputs | 3 (PNP, additional 1 x "Device Ready") |
| Delay time | 67 ms ... 30,000 ms (configurable) |
| Dwell time | 67 ms ... 10,000 ms (configurable) |
| Optical indicators | 2 LEDs (ON, switching status) |

Ambient data

| | |
|--|---|
| Object remission | 4 % ... > 1,000 % (reflectors) |
| Electromagnetic compatibility (EMC) | IEC 61000-6-3:2006+AMD1:2010 / IEC 61000-6-2:2005 |
| Vibration resistance | IEC 60068-2-6:2007 |
| Shock resistance | IEC 60068-2-27:2008 |
| Ambient operating temperature | -10 °C ... +50 °C |
| Storage temperature | -30 °C ... +70 °C |
| Ambient light immunity | 80,000 lx |

General notes

| | |
|--------------------|---|
| Note on use | The sensor does not constitute a safety component as defined by relevant legislation on machine safety. |
|--------------------|---|

Classifications

| | |
|-----------------------|----------|
| ECl@ss 5.0 | 27270990 |
| ECl@ss 5.1.4 | 27270990 |
| ECl@ss 6.0 | 27270913 |
| ECl@ss 6.2 | 27270913 |
| ECl@ss 7.0 | 27270913 |
| ECl@ss 8.0 | 27270913 |
| ECl@ss 8.1 | 27270913 |
| ECl@ss 9.0 | 27270913 |
| ETIM 5.0 | EC002550 |
| ETIM 6.0 | EC002550 |
| UNSPSC 16.0901 | 46171620 |

Dimensional drawing (Dimensions in mm (inch))

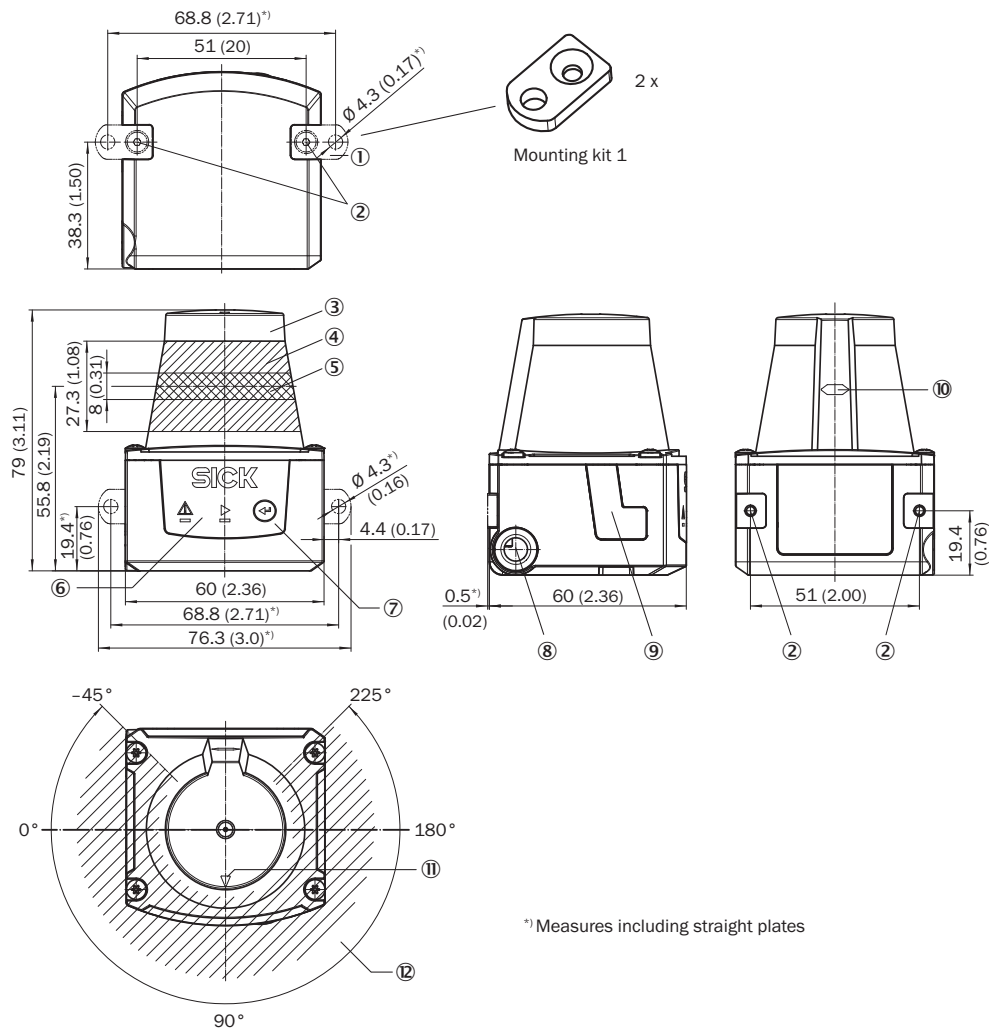

^{*} Measures including straight plates

- ① 2 x straight plates with M3 x 4 mm screw (included in delivery)
- ② M3 threaded mounting hole, 2.8 mm deep (blind hole thread)
- ③ Optical hood
- ④ Receiving range (light inlet)
- ⑤ Transmission range (light emission)
- ⑥ Red and green LED (status displays)
- ⑦ Function button for teach-in
- ⑧ Connecting cable outlet (connection for power/digital inputs/outputs)
- ⑨ Micro USB female connector, type B
- ⑩ Marking for the position of the light emission level
- ⑪ Bearing marking to support alignment (90° axis)
- ⑫ Aperture angle 270° (scanning angle)

Working range diagram

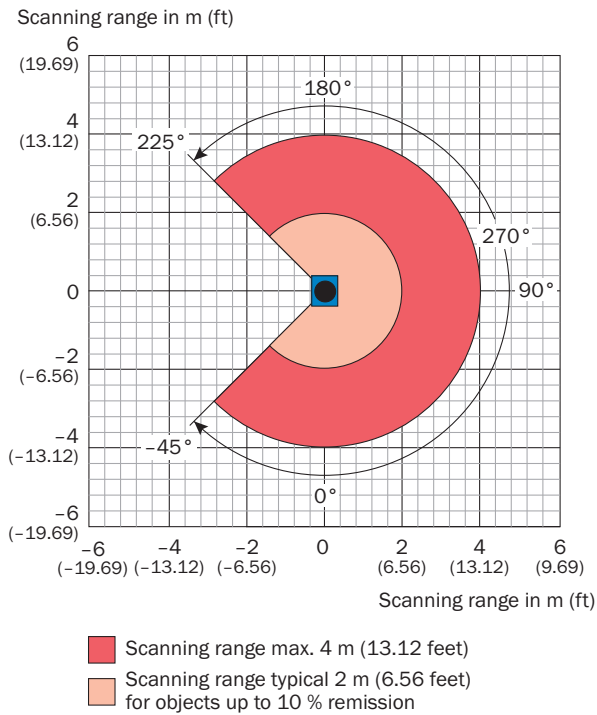

PIN assignment



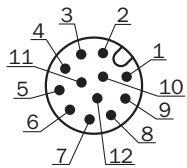

Power I/O connection



- ① GND
- ② DC 9 V ... 28 V
- ③ In₁
- ④ In₂
- ⑤ OUT1
- ⑥ OUT2
- ⑦ OUT3
- ⑧ OUT4
- ⑨ PNP: INGND, NPN: IN 9 V ... 28 V
- ⑩ In₃
- ⑪ In₄
- ⑫ nc

Recommended accessories

Other models and accessories → www.sick.com/TiM3xx

| | Brief description | Type | Part no. |
|--|---|--------------------|----------|
| Mounting brackets and plates | | | |
|  | Mounting kit with shock absorber, Anodized aluminum | Mounting kit | 2086074 |
|  | Mounting set 2, fender and alignment aid, Anodized aluminum | Mounting kit 2 | 2061776 |
| Plug connectors and cables | | | |
|  | Head A: female connector, M12, 12-pin, straight, A-coded Head B: Flying leads Cable: Power, I/O, PUR, shielded, 5 m | YF2A6B-050UD3XLEAX | 6054974 |
|   | Head A: male connector, USB-A Head B: male connector, Micro-B Cable: USB 2.0, unshielded, 2 m | USB cable | 6036106 |

Recommended services

Additional services → www.sick.com/TiM3xx

| | Type | Part no. |
|--|---|----------|
| Warranty extensions | | |
| <ul style="list-style-type: none"> • Product area: Identification solutions, Vision, Distance sensors, Detection and ranging solutions • Range of services: The services correspond to the scope of the statutory manufacturer warranty (SICK general terms and conditions of purchase), Long-term protection for calculable lump sum. • Duration: Five-year warranty from date of purchase. | Five-year extended warranty | 1680671 |
| Training | | |
| <ul style="list-style-type: none"> • Product family group: 2D LiDAR sensors, 3D LiDAR sensors • Range of services: The training contents relate to the following 2D and 3D LiDAR sensors: LMS series, MRS1000, MRS6000, NAV series or TiM series, Training format and location can be worked out in collaboration with SICK • Note: A minimum and maximum number of participants is determined based on the training format, depending on the training format, content and location, a training course may take place over the course of one or more work days • Duration: The fixed price includes the specific training services agreed upon, the fixed price includes the work time required for the training services and depends on the range of services, Additional work will be invoiced separately • Travel expenses: The prices include costs for the travel time and expenses, travel costs, such as flight or hotel expenses, are not included | Training LMS/MRS/NAV/TiM | 1612234 |
| Commissioning | | |
| <ul style="list-style-type: none"> • Product area: 2D LiDAR sensors, 3D LiDAR sensors • Range of services: Inspection of connection, fine adjustment, configuration of monitored areas, configuration and optimization of parameters of the LMS/MRS/NAV/TiM as well as verification tests, Setup of previously defined functions of basic settings, parameters of field application, filters for raw data output and product-specific configuration • Documentation: Archiving of product parameters in a SICK database, Documentation of performance, Creation of a commissioning log • Duration: Additional work will be invoiced separately • Note: The prices do not include expenses or costs for the travel time | Commissioning LMS/MRS/NAV/TiM (Prime package) | 1680672 |

| | Type | Part no. |
|---|---------------------------------|----------|
| Maintenance | | |
| <ul style="list-style-type: none">• Product area: 2D LiDAR sensors, 3D LiDAR sensors• Range of services: Inspection, analysis and restoring of defined functions, Inspection and adaptation of basic settings, parameters of field application, filters for raw data output, and product-specific configuration• Documentation: Documentation of operating hours and archiving of parameters in a SICK database, Creation of a maintenance log• Duration: Additional work will be invoiced separately• Note: The prices do not include expenses or costs for the travel time | Maintenance LMS/ MRS/NAV/TiM | 1682593 |

SICK AT A GLANCE

SICK is one of the leading manufacturers of intelligent sensors and sensor solutions for industrial applications. A unique range of products and services creates the perfect basis for controlling processes securely and efficiently, protecting individuals from accidents and preventing damage to the environment.

We have extensive experience in a wide range of industries and understand their processes and requirements. With intelligent sensors, we can deliver exactly what our customers need. In application centers in Europe, Asia and North America, system solutions are tested and optimized in accordance with customer specifications. All this makes us a reliable supplier and development partner.

Comprehensive services complete our offering: SICK LifeTime Services provide support throughout the machine life cycle and ensure safety and productivity.

For us, that is “Sensor Intelligence.”

WORLDWIDE PRESENCE:

Contacts and other locations –www.sick.com