

Product designation				Fuse holder
Product type designation				FB
Number of DIN modules				4
Operating voltage type				AC
Electrical features				
Rated current (In)	A			100
Rated operational voltage	V			690
IEC Utilization category				AC21B 690V
Total power dissipation	W			9.5
Derating factor of rated current In for different ambient temperature	20°C			1
	30°C			0.95
	40°C			0.9
	50°C			0.8
	60°C			0.7
	70°C			0.5
Derating factor of rated current In for side by side fuse holders (poles)	1-4			1
	5-6			0.8
	7-9			0.7
	≥10			0.6
Ambient conditions				
Operating temperature	min	°C	-40	
	max	°C	70	
Storage temperature	min	°C	-40	
	max	°C	80	
Max altitude			m	3000
Mechanical features				
Operating position	normal allowable		Vertical plan	
			Any	
Mounting				35mm DIN rail
Tightening torque for terminals	max	Nm	4	
	max	lbft	1.8	
Conductor section	- Flexible max (IEC)		mm ²	35
	- Flexible max (AWG)			2
	- Rigid max (IEC)		mm ²	50
	- Rigid max (AWG)			1
Weight			g	354
Frontal IP degree				IP20
Dimensions				

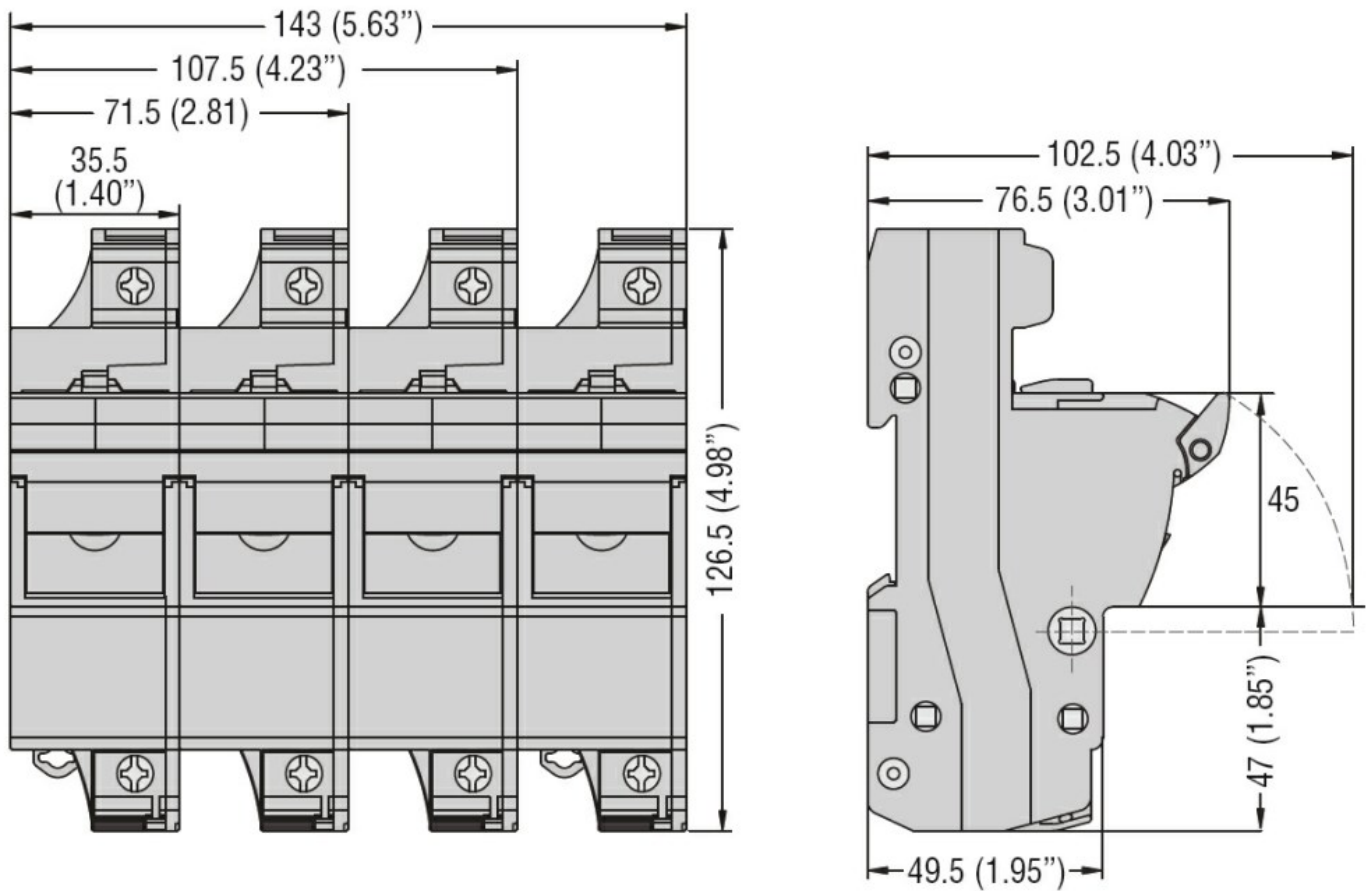

Certifications and compliance

Compliance

CSA C22.2 n°4248.1

IEC/EN 60269-1

IEC/EN 60269-2

IEC/EN 60947-1

IEC/EN 60947-3

UL 4248-1

Certifications

cURus

EAC