

- > **Port size: G1/4 or G3/8**
- > **Excelon design allows in-line installation or modular installation with other Excelon products**
- > **High efficiency water and particle removal**
- > **Quick release bayonet bowl**
- > **Push to lock adjusting knob with tamper resistant accessory**
- > **Flow sensor provides a nearly constant oil/air ratio over a wide range of flows**
- > **All round (360°) visibility of sightfeed dome for ease of drip rate setting**

Technical features - standard models
Medium:

Compressed air only

Maximum operating pressure:

10 bar (145 psi)

Pressure range:

0,3 ... 10 bar (4 ... 145 psi)

Filter element:

40 µm standard

Port size:

G1/4, G3/8

Gauge port:

Rc 1/8

Relieving:

Standard

Flow:

BL72: 13 dm³/s maximum

At port size: G1/4

Inlet pressure: 10 bar (145 psi)

Outlet pressure: 6,3 bar (91 psi)

 Δp : 1 bar (14,5 psi)

Filter element: 40 µm

Drain:

Manual or automatic

Automatic drain operating conditions (float operated):

Bowl pressure required to close drain: > 0,35 bar (5 psi)

Bowl pressure required to open drain: ≤ 0,2 bar (2.9 psi)

Minimum air flow required to

close drain: 0,1 dm³/s (0.2 scfm)

Manual operation: depress pin

inside drain outlet to drain bowl

Ambient/Media temperature:

-20 ... +50°C (-4 ... +122°F)

Air supply must be dry enough to avoid ice formation at temperatures below +2°C (+35°F).

Materials:

Body: zinc

Bowl: PC

Elastomers: CR & NBR

Please contact IMI Norgren for following options:
Operation pressure:

Metal bowl: 17 bar (246 psi)

Metal bowl with automatic drain:

10 bar (145 psi)

Port size:

1/4 or 3/8 NPT

Pressure range:

0,3 ... 4 bar (4 ... 58 psi)

0,3 ... 2 bar (4 ... 29 psi)

0,3 ... 17 bar (4 ... 247 psi)

Filter element:

5 µm

Gauge port:

1/8 PTF with PTF main ports

Relieving:

Without

Drain:

Semi-automatic

Ambient/Media temperature:





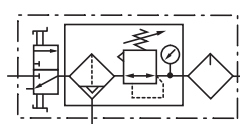
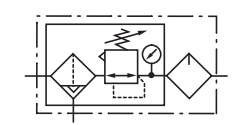
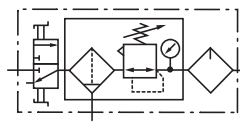
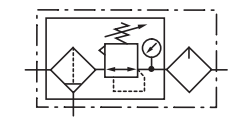

Metal bowl:

-34 ... +65°C (-29 ... +149°F)

Technical data BL72 (Filter/Regulator, Lubricator and Gauge) - standard models



Symbol	Air port	Pressure range (bar)	Element (µm)	Drain	Lubricator	Mounting	Shut-off valve	Model
	G 1/4	0,3 ... 10	40	Automatic	Micro fog	Quikclamp with wall bracket®	with	BL72-201GA
	G 3/8	0,3 ... 10	40	Automatic	Micro fog	Quikclamp with wall bracket®	with	BL72-301GA
	G 1/4	0,3 ... 10	40	Automatic	Oil fog	Quikclamp with wall bracket®	with	BL72-211GA
	G 3/8	0,3 ... 10	40	Automatic	Oil fog	Quikclamp with wall bracket®	with	BL72-311GA
	G 1/4	0,3 ... 10	40	Automatic	Micro fog	Quikclamp with wall bracket®	without	BL72-205GA
	G 3/8	0,3 ... 10	40	Automatic	Micro fog	Quikclamp with wall bracket®	without	BL72-305GA
	G 1/4	0,3 ... 10	40	Automatic	Oil fog	Quikclamp with wall bracket®	without	BL72-215GA
	G 3/8	0,3 ... 10	40	Automatic	Oil fog	Quikclamp with wall bracket®	without	BL72-315GA
	G 1/4	0,3 ... 10	40	Manual	Micro fog	Quikclamp with wall bracket®	with	BL72-221G
	G 3/8	0,3 ... 10	40	Manual	Micro fog	Quikclamp with wall bracket®	with	BL72-321G
	G 1/4	0,3 ... 10	40	Manual	Oil fog	Quikclamp with wall bracket®	with	BL72-231G
	G 3/8	0,3 ... 10	40	Manual	Oil fog	Quikclamp with wall bracket®	with	BL72-331G
	G 1/4	0,3 ... 10	40	Manual	Micro fog	Quikclamp with wall bracket®	without	BL72-225G
	G 3/8	0,3 ... 10	40	Manual	Micro fog	Quikclamp with wall bracket®	without	BL72-325G
	G 1/4	0,3 ... 10	40	Manual	Oil fog	Quikclamp with wall bracket®	without	BL72-235G
	G 3/8	0,3 ... 10	40	Manual	Oil fog	Quikclamp with wall bracket®	without	BL72-335G

Accessories

<p>Quikclamp®</p>  <p>Page 3</p> <p>4214-51</p>	<p>Quikclamp with wall bracket®</p>  <p>Page 3</p> <p>4214-52</p>	<p>Tamper resistant kit</p>  <p>4255-51</p>	
<p>Quikmount pipe adaptor *1)</p>  <p>Page 3</p> <p>G1/4: 4215-08 G3/8: 4215-09</p>	<p>Porting block with three alternative ports</p>  <p>Page 3</p> <p>G1/4: 4216-52</p>	<p>2/2 Shut-off valves (for full technical specification see datasheet 8.160.600)</p>  <p>Page 4</p> <p>G1/4: T72B-2GA-P1N G3/8: T72B-3GA-P1N</p>	<p>3/2 Shut-off valves (for full technical specification see datasheet 8.160.600)</p>  <p>Page 4</p> <p>G1/4: T72T-2GA-P1N G3/8: T72T-3GA-P1N</p>

*1) Please use a Quikmount pipe adaptor if the Quikclamp be mounted at inlet or outlet side.

Pressure switch

<p>Porting block for pressure switch</p>  <p>0523109000000000</p>	<p>Pressure switch (0,5 ... 8 bar)</p>  <p>0881300000000000</p>	<p>Padlock (brass) with two keys *1)</p>  <p>0613633000000000</p>
--	--	--

*1) for shut-off valves and tamper resistant kit

Gauge

Center back connection, white face (for full technical specification see datasheet 8.900.900)



Pressure range bar *1	Mpa	psi	Ø	Thread size	Model
0 ... 2,5	—	0 ... 36	40 mm	R1/8	18-015-886
0 ... 4	0 ... 0,4	0 ... 58	40 mm	R1/8	18-015-990
0 ... 10	0 ... 1	0 ... 145	40 mm	R1/8	18-015-989

*1) primary scale

Dimensions BL72

Dimensions in mm
 Projection/First angle

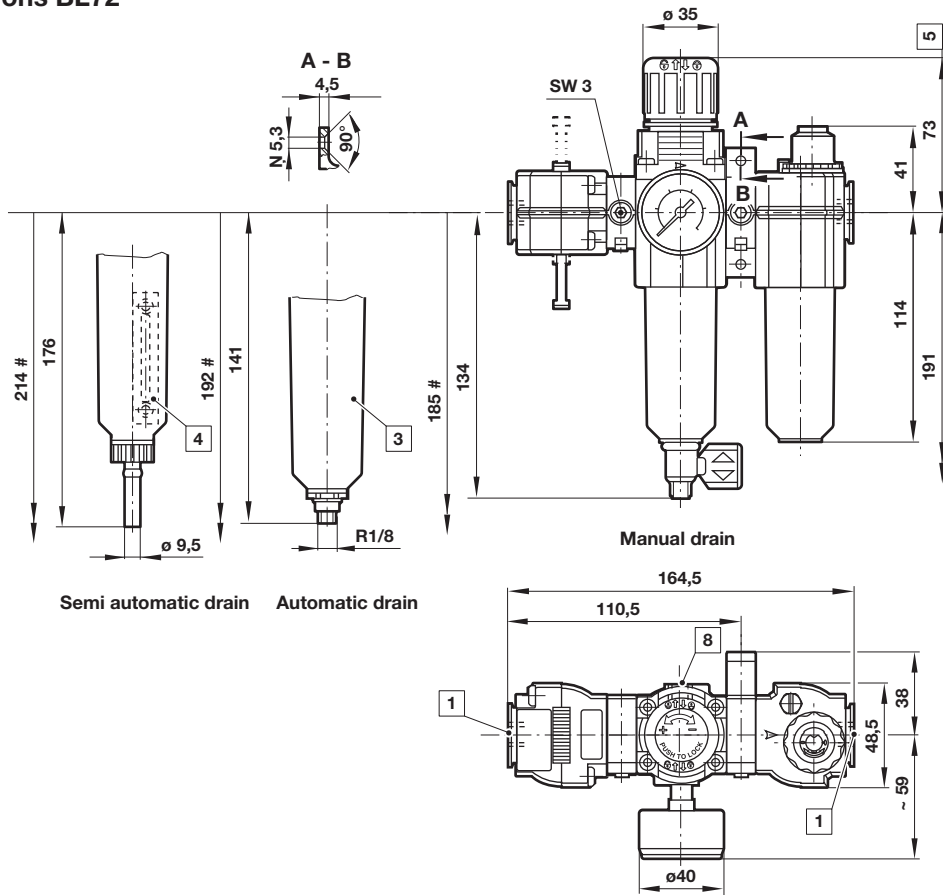

- # Minimum clearance required to remove bowl
- 1 Main ports 1/4" or 3/8"
- 3 Transparent bowl
- 4 Metal bowl with liquid indicator
- 5 Reduces by 4 mm with knob in locked position
- 8 Alternative gauge port Rc1/8 plugged

Accessories

Quikclamp®

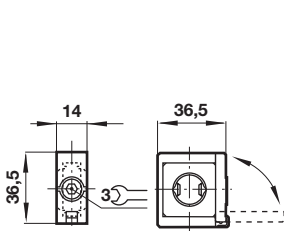

Quikclamp® with wall bracket

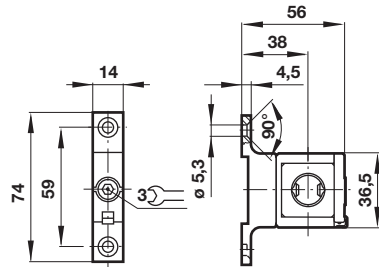

Porting block

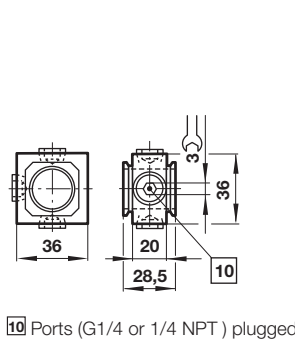

Pipe adapter

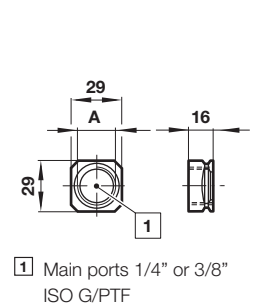

Wall mounting bracket

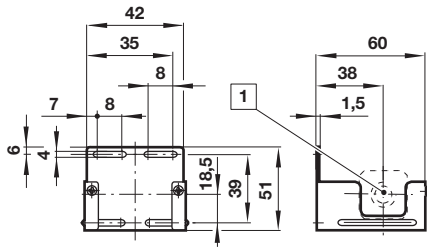

1 Main ports

Neck mounting bracket

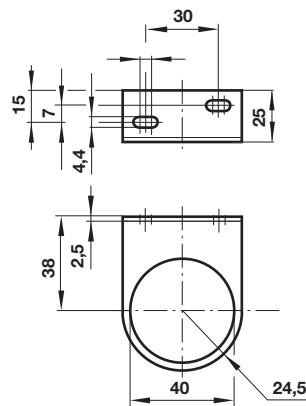

Shut-off valves

Dimensions in mm
 Projection/First angle

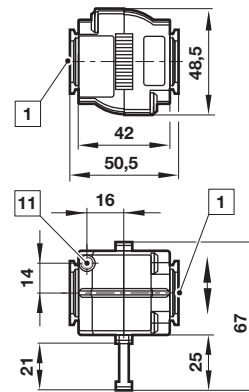

1 Main ports 1/4" or 3/8" ISO G/PTF
 11 Exhaust port M5 at 3/2 valve only

Porting block for pressure switch

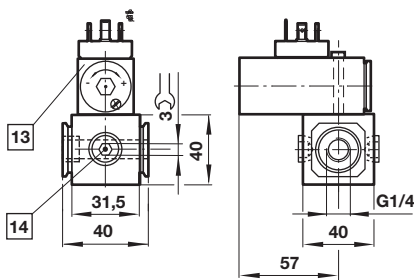

13 Pressure switch is not in scope of delivery
 14 Alternative G1/4 ports plugged

Warning

These products are intended for use in industrial compressed air systems only. Do not use these products where pressures and temperatures can exceed those listed under »**Technical features/data**«.

Before using these products with fluids other than those specified, for non-industrial applications, life-support systems or other applications not within published specifications, consult IMI Precision Engineering, Norgren GmbH.

Through misuse, age, or malfunction, components used in fluid power systems can fail in various modes.

The system designer is warned to consider the failure modes of all component parts used in fluid power systems and to provide adequate safeguards to prevent personal injury or damage to equipment in the event of such failure.

System designers must provide a warning to end users in the system instructional manual if protection against a failure mode cannot be adequately provided.

System designers and end users are cautioned to review specific warnings found in instruction sheets packed and shipped with these products.