

# Digital chronothermostats



Geolocation



Comfort



Energy  
savings



Ecological



Flexibility



Heating and  
cooling



Building  
automation





**Smart thermostat BLISS2**

- Remote management via the APP (Android or iOS) thanks to the Wi-Fi Gateway2, 1Y.GU.005.1
- Without internet connection, the Bliss2 can be set up via Gateway using the Bluetooth communication
- Stunning design LED matrix display
- Touch keys
- 3x batteries, type AAA (estimated electrical life of 1.5 years)
- Timed manual operation from 1 hour to 99 hours, or permanent mode
- Summer/winter function
- Temperature setting +5...+37°C
- Humidity sensor 1%...99%
- Contact rating 5 A 250 V AC
- Perfect for direct surface mounting or installation over "503" or 60 mm round wall boxes

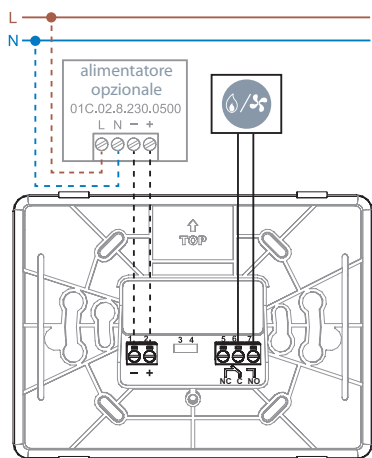

**NEW 1C.B1 BLISS2**

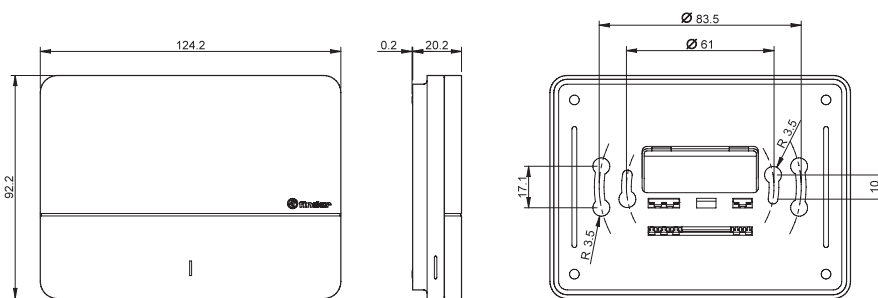

**Colour**

White

**Smart thermostat BLISS2**

1C.B1.9.005.0007

**Technical features**

Sensing element	Electronic sensor
Supply	3 batteries 1.5 V AAA or with optional external power supply (page 4)
Contact configuration	1 CO (SPDT)
Contact rating	5 A/250 V AC
Display range	0...+50 °C
Temperature setting range	+5...+37 °C
Temperature differential	0.1...0.9 °C / settable by App
Humidity sensor	1...99%
Nighttime set-back	—
Independently set temperature levels	from 5...37 °C
Protection category	IP 20
Mounting	Surface
Display resolution	0.1 °C
Accuracy at +20 °C	+/-0.5 °C
Frost Protection	+5 °C
Weekly/Daily	Weekly settable via App
Minimum programming interval	15 minute
Energy saving function	Geolocation
Push buttons	Touch keys
Supervisory control	NO
Back-light display	YES
Communications	868MHz RF and Wi-Fi via Gateway2 Type 1Y.GU.005.1
APP programming	YES
<b>Approvals</b> (according to type)	<b>CE EAC</b>



## BLISS2

### With BLISS2

- Read the room Relative Humidity value
- Program the thermostat in manual mode
- Manage the thermostat remotely via the Finder Bliss app
- Manage the room temperature through voice assistants



#### %HR

Display of Relative Humidity currently present in the atmosphere.



#### ROOM TEMPERATURE

Thermostat is set to AUTOMATIC mode (AUTO) and will respond to programming via the App.



#### SETTINGS MENU

From here you can access the device settings.

### Type 1Y.GU.005.1

### Gateway di seconda generazione

## GATEWAY2

The second generation GATEWAY2 (1Y.GU.005.1) integrates perfectly with Finder's YESLY comfort living system and BLISS2.

With the installation of GATEWAY2, BLISS2 and other Finder smart home YESLY products you have the ability to check or change your home's temperature, turn on the lights, close the shutters, or recall customized scenarios via Wi-Fi, all by using the dedicated Finder apps for BLISS and YESLY.

**And importantly, even with the loss of the Wi-Fi network your BLISS2 and YESLY devices will still be controllable via Bluetooth.**



2.4  
GHz

Up to 10 BLISS2 can be paired with each GATEWAY2





**Type 01C.02.8.230.0500**  
**Power supply for smart thermostat BLISS2**

**This power supply is perfect for installations with multiple thermostats, in both the residential and commercial sectors. In particular: hotel, B&B, offices and similar.**

- Rated power: 2 W
- Nominal voltage: 110...230 V AC
- Output voltage: 5 V DC
- Ambient temperature range: 0...40°C
- Maximum cable length between power supply and BLISS2:  
40 m (2x1.5 mm<sup>2</sup> flexible cable)

When using the smart thermostat BLISS2 with the external power supply, the batteries **MUST** be removed.

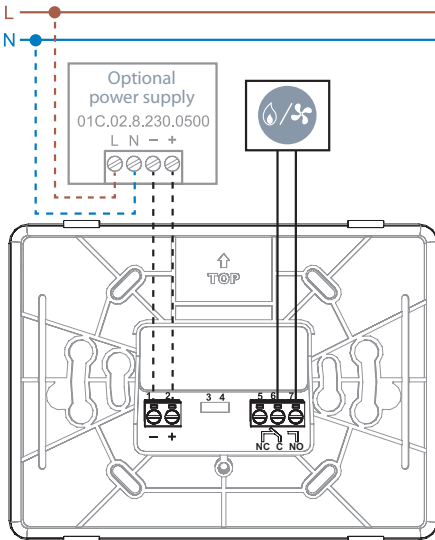

**With Finder Bliss app**

- Remotely manage the thermostat easily and intuitively
- Create and edit weekly time schedules
- Share and manage your thermostat from multiple smartphones and different users
- Control multiple thermostats within the same house or in different homes
- Check the working time of the heating system and monitor its performance by viewing the deviation between the set and measured temperatures
- Set the AUTO-AWAY geolocation energy saving function



The BLISS2 thermostat is available in two different packs:



**Packaging code: 1C.B1.9.005.0007.POA**

This bundle contains 1 BLISS2 thermostat + 1 GATEWAY2.  
The GATEWAY2 is essential for working in smart mode, and is able to pair with up to 10 BLISS2 devices.



**BLISS2**  
Thermostat  
1C.B1.9.005.0007



**GATEWAY2**  
GATEWAY2  
1Y.GU.005.1



**Packaging code: 1C.B1.9.005.0007**

This package contains a single BLISS2 thermostat and is for those who need to install multiple devices and are already in possession of the appropriate GATEWAY2.

**Easily replace your old wall-mounted thermostat**

BLISS2 is a simple solution for replacing an existing thermostat whether it be powered by a battery or wired to a power supply, or whether it is directly surface mounted or fitted on an electrical wall box.

To use BLISS2 in smart mode, simply connect the GATEWAY2 to the electrical socket and pair the devices via the Finder Bliss app. You can replace any Finder or other brand of thermostat\*.

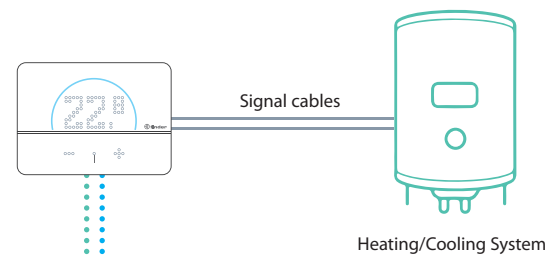
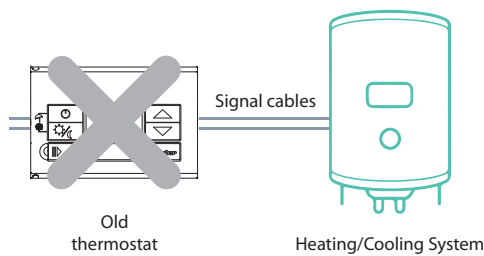

\* For thermostats with equivalent underlying functionality. For more information or assistance, contact our local sales office or toll-free number

Connect the GATEWAY2 to the socket using the supplied connection cable

**Wi-Fi Chronothermostat**

- Remote management via the APP (Android or iOS)
- Manual, or guided APP programming
- Stunning design
- Touch keys
- 4 batteries 1.5 V AA
- Summer/winter function
- PIN lock padlock function
- Setting 5...37°C
- Contact rating 5 A 250 V AC

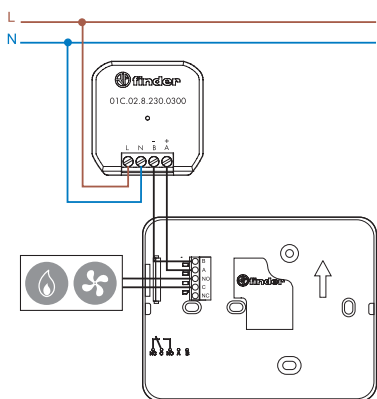

Wiring diagram

**1C.91**

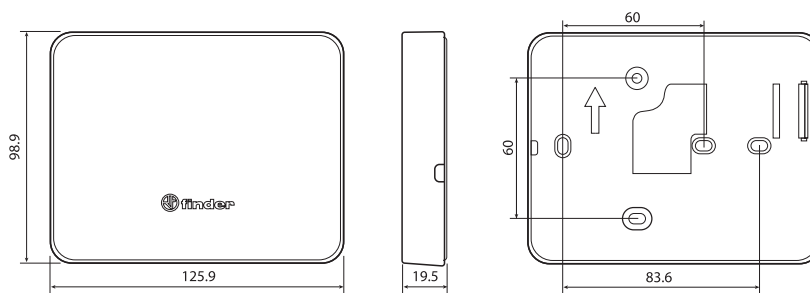

Colour	Weekly Chronothermostat
White	1C.91.9.003.0W07
Technical features	
Sensing element	NTC
Supply	4 batteries 1.5 V AA
Contact configuration	1 CO (SPDT)
Contact rating	5 A/250 V AC
Display range	0...+50 °C
Temperature setting range	+5...+37 °C
Temperature differential	0.2 °C self-adjusting / settable by APP
Temperature rate of change	—
Nighttime set-back	—
Independently set temperature levels	from 5...37 °C
Thermostat lock	3 digit PIN
Protection category	IP 20
Mounting	Surface
Display resolution	0.1 °C
Accuracy at +20 °C	+/-0.5 °C
Frost Protection	+5 °C
Weekly/Daily	Weekly
Minimum programming interval	1 hour
Energy saving function	Geolocation
Push buttons	Touch keys
Supervisory control	NO
Back-light display	YES
Communications	Wi-Fi
APP programming	YES
<b>Approvals</b> (according to type)	<b>CE EAC</b>

## Programming mode with Wi-Fi

### Remote control

The BLISS Finder APP allows you to manage your BLISS Wi-Fi chronothermostat wherever you are.

Connecting your BLISS Wi-Fi to the home network you can:

- decide to change the set temperature at any time
- activate the **AUTOAWAY** function to save energy automatically when you leave home
- create your favorite weekly or daily programs
- manage all your chronothermostats in your home or in different homes
- share your **BLISS** settings with other users

### New APP for quick and easy programming



AVAILABLE ON

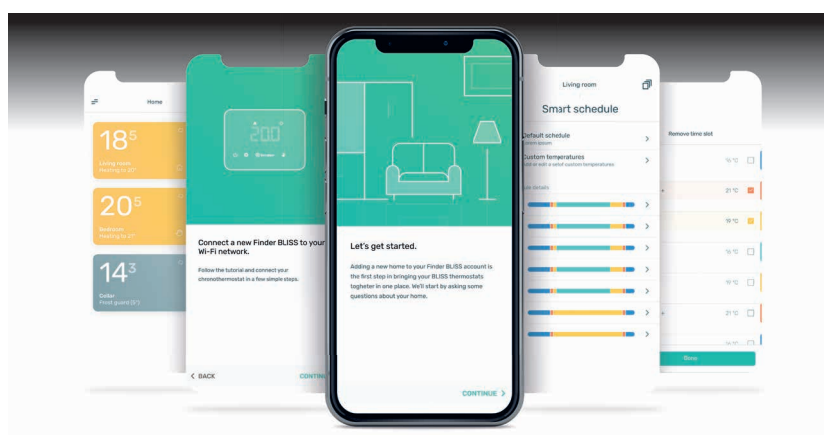

### Touch keys

#### Turn on the display using the "Finder" button



#### Adjustment



### Statistics and Reporting

Manage the consumption history over a selected period. Optimize the heating by monitoring the boiler switch-on times for greater energy savings.

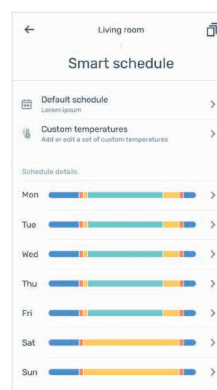
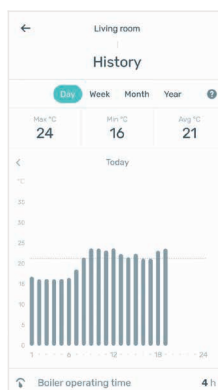



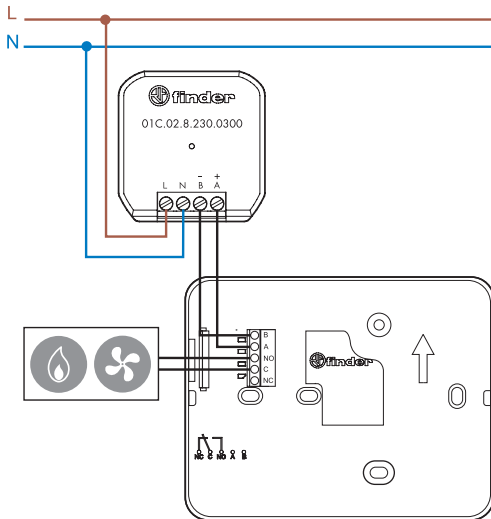

### Type 01C.02.8.230.0300 Power supply for chronothermostat BLISS Wi-Fi

- Rated power: 2 W
- Nominal voltage: 110...230 V AC
- Output voltage: 3.3 V DC
- Ambient temperature range: 0...40 °C
- Maximum cable length between power supply and chronothermostat BLISS Wi-Fi: 10 m (2x1.5 mm<sup>2</sup> flexible cable)

When using the chronothermostat with the external power supply, the batteries **MUST** be removed.

Within the application, in the "Update time" section, Level 4 (fast connection) can be set.

**Digital touch basic room chronothermostat**

- Touch display with guided programming
- Ultra-compact design
- 3 programmable temperature levels
- Functions: party program, recalibration of displayed temperature, manual timed with calendar setting, frost protection, pump anti-seizure and calibration functions
- Summer/Winter switch
- Simple touch screen blocking or full 3-digit PIN lock
- Calendar with automatic leap year & daylight-saving updates
- Partial display block or full lock with PIN code
- Multi-function and multi-touch buttons
- Surface mounting over 3 module wall box (eg. type 503)

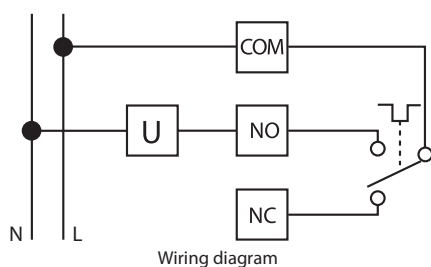
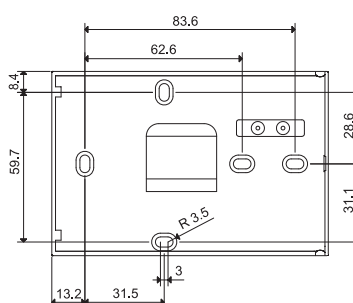
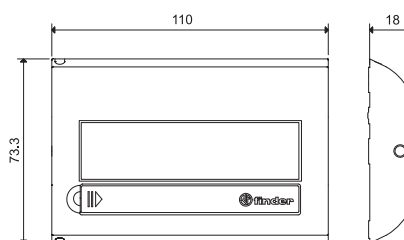
**1C.71**

Colour	Weekly Program
White	1C.71.9.003.0007
Technical features	
Sensing element	NTC
Supply	2 batteries 1.5 V AAA
Contact configuration	1 CO (SPDT)
Contact rating	5 A/250 V AC
Display range	0...+50 °C
Temperature setting range	+5...+37 °C
Temperature differential	0.1...0.9 °C
Temperature rate of change	—
Nighttime set-back	—
Independently set temperature levels	3
Thermostat lock	Basic or 3 digit PIN
Protection category	IP 20
Mounting	Surface
Display resolution	0.1 °C
Accuracy at +20 °C	+/-0.5 °C
Frost Protection	+2...+8 °C
Weekly/Daily	Weekly
Minimum programming interval	1 hour
Energy saving function	—
Push buttons	Touch screen
Supervisory control	NO
Back-light display	NO
Communications	—
APP programming	—
<b>Approvals</b> (according to type)	<b>CE EAC</b>

**Digital "touch slide" chronothermostat**

- Touch display with guided programming
- Chronothermostat "touch slide" ultra-thin 17 mm only with wide display
- Easy to use
- Summer/Winter switch
- 24 point for temperature setting
- Basic display lock or advanced with PIN, with storage of all settings
- Minimum interval setting 15 minutes
- The weekly function allows each day to be set to, automatic mode, hand mode, or OFF
- Calibration function
- Input for remote control
- Dynamic icons
- Surface mounting over 3 module wall box (eg. type 503)

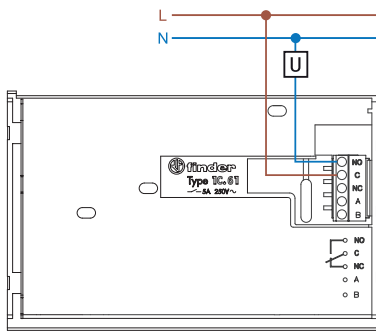

Wiring diagram

**1C.61**

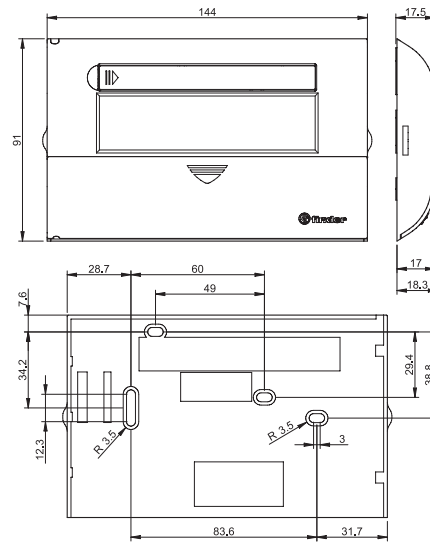

Colour	Daily Program
White RAL 9010	1C.61.9.003.0101
Technical features	
Sensing element	NTC
Supply	2 batteries 1.5 V AAA
Contact configuration	1 CO (SPDT)
Contact rating	5 A/250 V AC
Display range	0...+50 °C
Temperature setting range	+5...+37 °C (with sliders: <b>winter</b> +6...+24 °C/ <b>summer</b> +18...+30 °C)
Temperature differential	0.1...0.9 °C
Temperature rate of change	—
Nighttime set-back	—
Independently set temperature levels	Sliders
Thermostat lock	Basic or 3 digit PIN
Protection category	IP 20
Mounting	Surface
Display resolution	0.5 °C
Accuracy at +20 °C	+/-0.5 °C
Frost Protection	+2...+8 °C
Weekly/Daily	Daily + 7 Daily
Minimum programming interval	1 h or 15 minutes - daily/weekly (weekly: only Auto, Manual and OFF mode)
Energy saving function	—
Push buttons	Touch screen
Supervisory control	NO
Back-light display	YES
Communications	—
APP programming	—
<b>Approvals</b> (according to type)	<b>CE EAC</b>

