

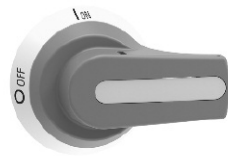

LOVATO ELECTRIC S.P.A.

24020 GORLE (BERGAMO) ITALIA
 VIA DON E. MAZZA, 12
 TEL. 035 4282111
 FAX (Nazionale): 035 4282200
 FAX (International): +39 035 4282400
 E-mail info@LovatoElectric.com
 Web www.LovatoElectric.com



- ① MANIGLIA A LEVA CON SBLOCCO
 - ② PISTOL GRIP DEFEATABLE HANDLE
 - ③ GRIFF MIT WÄHLSCHALTER UND TÜRVERRIEGLUNGS
 - ④ POIGNEE PISTOLET AVEC DECLENCHEUR
 - ⑤ MANDO SELECTOR CON DESBLOQUEO
- GAX66... , GAX7300AN**



WARNING!

- This equipment is to be installed by qualified personnel, complying to current standards, to avoid damages or safety hazards.
- The manufacturer cannot be held responsible for electrical safety in case of improper use of the equipment.
- Products illustrated herein are subject to alteration and changes without prior notice. Technical data and descriptions in the documentation are accurate, to the best of our knowledge, but no liabilities for errors, omissions or contingencies arising there from are accepted.



ATTENZIONE!

- Questi apparecchi devono essere installati da personale qualificato, nel rispetto delle vigenti normative impiantistiche, allo scopo di evitare danni a persone o cose.
- Il costruttore non si assume responsabilità in merito alla sicurezza elettrica in caso di utilizzo improprio del dispositivo.
- I prodotti descritti in questo documento sono suscettibili in qualsiasi momento di evoluzioni o di modifiche. Le descrizioni ed i dati a catalogo non possono pertanto avere alcun valore contrattuale.



ATTENTION !

- Ces appareils doivent être installés par un personnel qualifié, conformément aux normes en vigueur en matière d'installations, afin d'éviter de causer des dommages à des personnes ou choses.
- Le constructeur n'assume aucune responsabilité quant à la sécurité électrique en cas d'utilisation impropre du dispositif.
- Les produits décrits dans ce document sont susceptibles d'évoluer ou de subir des modifications à n'importe quel moment. Les descriptions et caractéristiques techniques du catalogue ne peuvent donc avoir aucune valeur contractuelle.



UWAGA!

- W celu uniknięcia obrażeń osób lub uszkodzenia mienia tego typu urządzenia muszą być instalowane przez wykwalifikowany personel, zgodnie z obowiązującymi przepisami.
- Producent nie przyjmuje na siebie odpowiedzialności za bezpieczeństwo elektryczne w przypadku niewłaściwego użytkowania urządzenia.
- Produkty opisane w niniejszym dokumencie mogą być w każdej chwili udoskonalone lub zmodyfikowane. Opisy oraz dane katalogowe nie mogą mieć w związku z tym żadnej wartości umownej.



ACHTUNG!

- Zur Vermeidung von Personen- und Sachschäden dürfen diese Geräte nur von qualifiziertem Fachpersonal und unter Befolgung der einschlägigen Vorschriften installiert werden.
- Bei zweckwidrigem Gebrauch der Vorrichtung übernimmt der Hersteller keine Haftung für die elektrische Sicherheit.
- Die in dieser Broschüre beschriebenen Produkte können jederzeit weiterentwickelt und geändert werden. Die im Katalog enthaltenen Beschreibungen und Daten sind daher unverbindlich und ohne Gewähr.



警告!

- 本设备只能由合格人员根据现行标准进行安装，以避免造成损坏或安全危害。
- 制造商不负责因设备使用不当导致的电气安全问题。
- 此处说明的产品可能会有变更，恕不提前通知。我们竭力确保本档中技术数据和说明的准确性，但对于错误、遗漏或由此产生的意外事件概不负责。



ADVERTENCIA

- Este dispositivo debe ser instalado por personal cualificado conforme a la normativa de instalación vigente a fin de evitar daños personales o materiales.
- El fabricante no se responsabilizará de la seguridad eléctrica en caso de que el dispositivo no se utilice de forma adecuada.
- Los productos descritos en este documento se pueden actualizar o modificar en cualquier momento. Por consiguiente, las descripciones y los datos técnicos aquí contenidos no tienen valor contractual.



ПРЕДУПРЕЖДЕНИЕ!

- Во избежание травм или материального ущерба монтаж должен осуществляться только квалифицированным персоналом в соответствии с действующими нормативами.
- Производитель не несет ответственность за обеспечение электробезопасности в случае ненадлежащего использования устройства.
- Изделия, описанные в настоящем документе, в любой момент могут подвергнуться изменениям или усовершенствованиям. Поэтому каталожные данные и описания не могут рассматриваться как действительные с точки зрения контрактов



UPOZORNĚNÍ

- Tato zařízení smí instalovat kvalifikovaní pracovníci v souladu s platnými předpisy a normami pro předcházení úrazů osob či poškození věcí.
- Výrobce nenese odpovědnost za elektrickou bezpečnost v případě nevhodného používání regulátorů.
- Výrobky popsané v tomto dokumentu mohou kdykoli projít úpravami či dalším vývojem. Popisy a údaje uvedené v katalogu nemají proto žádnou smluvní hodnotu.



DIKKAT!

- Bu aparatlar kışiler veya nesnelere zarar verme ihtimaline karşı yürürlükte olan sistem kuma normlarına göre kalifiye personel tarafından monte edilmelidirler
- Üretici aparatın hatalı kullanımından kaynaklanan elektriksel güvenliğe ait sorumluluk kabul etmez.
- Bu dokümanda tarif edilen ürünler her an evrimlere veya değişimlere açıktır. Bu sebeple katalogdaki tarif ve değerler herhangi bir bağlayıcı değeri haiz değildir.



AVERTIZARE!

- Acest echipament va fi instalat de personal calificat, în conformitate cu standardele actuale, pentru a evita deteriorări sau pericolele.
- Producătorul nu poate fi considerat responsabil pentru siguranța electrică în caz de utilizare incorectă a echipamentului.
- Produsele ilustrate în prezentul sunt supuse modificărilor și schimbărilor fără notificare anterioară. Datele tehnice și descrierile din documentație sunt precise, în măsura cunoștințelor noastre, dar nu se acceptă nicio răspundere pentru erorile, omisiunile sau evenimentele neprevăzute care apar ca urmare a acestora.

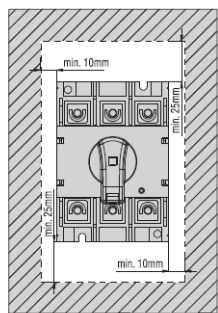

UL Marking:
 GA063... GA080... GA100... GA125...
 minimum enclosure size 150x140x110mm

GA063A...160A

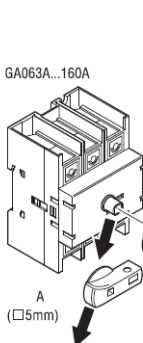

GE0160 - GE0160T4
 GE0160P - GE0160T4P
 GE0200 - GE0200T4
 GE0250 - GE0250T4

0,8 Nm/7.1 lbin

Phillips 1
 4,5mm
 0,8 Nm / 7.1 lbin

C (□7mm)

GAX7150AN
 GAX7200AN
 GAX7300AN
 GAX7400AN
 GAX7500AN

GAX7300AN SHAFT

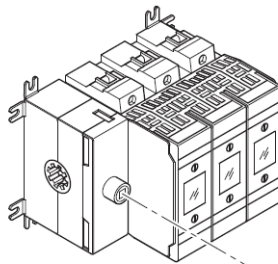

GMFJ030C12
 GMFC030C12
 GMFJ060C12
 GMFJ060C03
 GMFJ100C03
 GMFJ200C03

Attenzione
 Warning
 Achtung
 Atención

C (□6mm)

GMX7150S06
 GMX7300S06

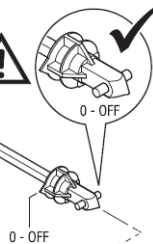

Phillips 2
 1.5 Nm / 13.3lbin

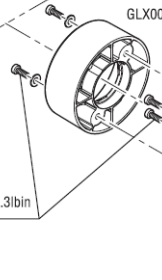

GAX66N
 GAX66NB

UL Marking: GAX66/66B for use on a flat surface, type 1, 4 and 4X, outdoor use.

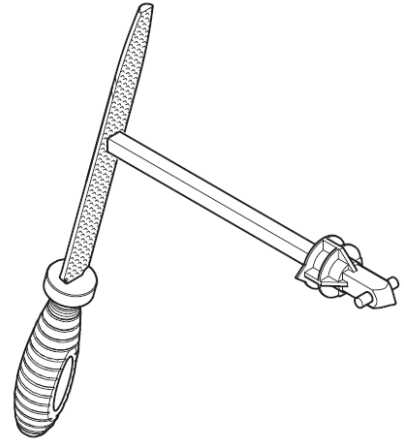
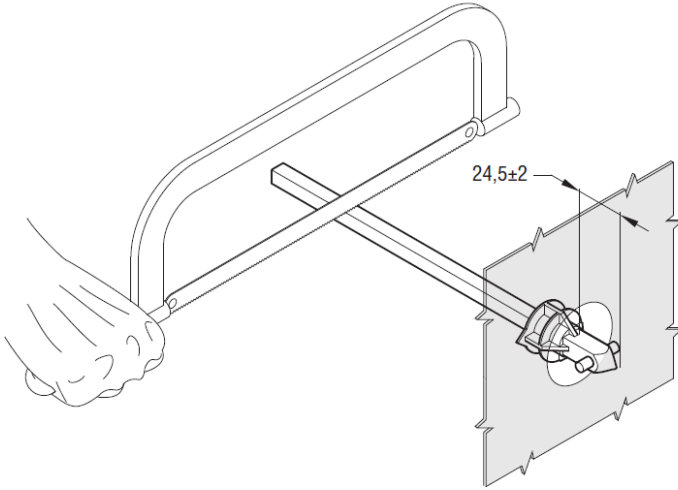

GAX66N - GAX66NB

