

Series
Version

BMF 303

BMF 303

BMF 303

BMF 305

connector for direct
connection to
distribution box



Ordering as a set

Sensor and bracket:
Please include code for bracket
in ordering code
e. g. BMF 303K/HW30-PS-C-2-PU-03
or BMF 305K/HW20-PS-C-2-PU-05
Magnetic field sensor and bracket
in one part number.

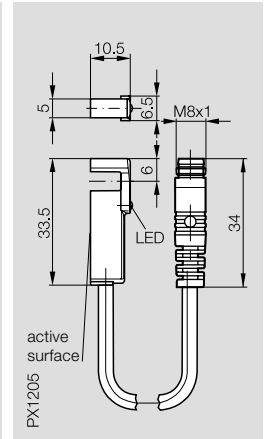
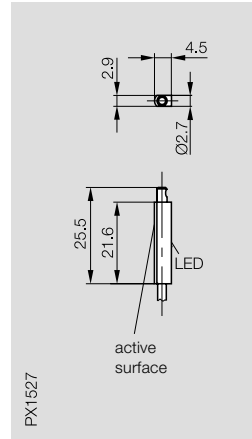
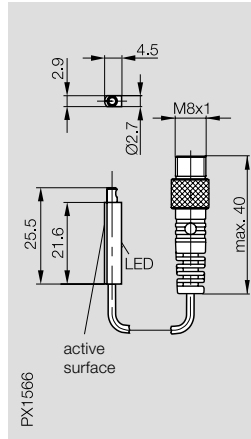
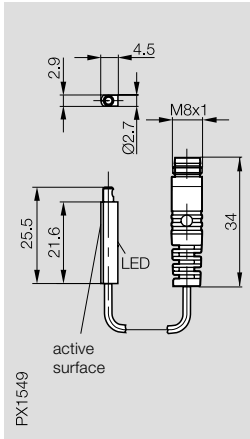

PNP Normally-open

BMF 303K-PS-C-2-S49-

BMF 303K-PS-C-2-SA 2-S49-

BMF 303K-PS-C-2-

BMF 305K-PS-C-2-S49-

NPN Normally-open

BMF 305K-NS-C-2-S49-

Rated operating field strength I_{H_n} | 1.2 kA/m
Assured operating field strength I_{H_a} | ≥ 2 kA/m
Hysteresis of I_{H_n} | ≤ 45 %
Temperature drift of turn-on point of I_{H_n} | ≤ 0.3 %/°C

1.2 kA/m	1.2 kA/m	1.2 kA/m	1.2 kA/m
≥ 2 kA/m	≥ 2 kA/m	≥ 2 kA/m	≥ 2 kA/m
≤ 45 %	≤ 45 %	≤ 45 %	≤ 45 %
≤ 0.3 %/°C	≤ 0.3 %/°C	≤ 0.3 %/°C	≤ 0.3 %/°C

Supply voltage U_B | 10...30 V DC
Voltage drop U_d | ≤ 3.1 V
Rated insulation voltage U_i | 75 V DC
Rated operational current I_e | 100 mA
No-load supply current I_0 max. | ≤ 12 mA
Off-state current I_r | ≤ 80 μ A
Protected against polarity reversal | yes
Short circuit protected | yes
Load capacity | ≤ 1 μ F
Ambient temperature range T_a | -25...+70 °C
Utilization category | DC 13
Degree of protection per IEC 60529 | IP 67
Housing material | LCP
Connection | cable with connector
No. of wires \times conductor cross section | 3 \times 0,06 mm²
Approval | cULus
Recommended connector | BKS-B 48

10...30 V DC	10...30 V DC	10...30 V DC	10...30 V DC
≤ 3.1 V	≤ 3.1 V	≤ 3.1 V	≤ 3.1 V
75 V DC	75 V DC	75 V DC	75 V DC
100 mA	100 mA	100 mA	200 mA
≤ 12 mA	≤ 12 mA	≤ 12 mA	≤ 30 mA
≤ 80 μ A	≤ 80 μ A	≤ 80 μ A	≤ 80 μ A
yes	yes	yes	yes
yes	yes	yes	yes
≤ 1 μ F	≤ 1 μ F	≤ 1 μ F	≤ 1 μ F
-25...+70 °C	-25...+70 °C	-25...+70 °C	-25...+70 °C
DC 13	DC 13	DC 13	DC 13
IP 67	IP 67	IP 67	IP 67
LCP	LCP	LCP	LCP
cable with connector	cable with connector	cable	cable with connector
3 \times 0,06 mm ²		3 \times 0,06 mm ²	
cULus	cULus	cULus	cULus
BKS-B 48			BKS-B 48

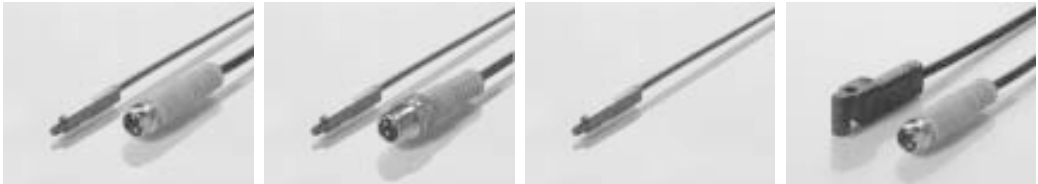

Please add the cable length to the ordering code for sensors with **cable!**
PU-03, PU-05 =
PUR, length 3 m or 5 m

Please add the cable length to the ordering code for sensors with **cable and connector!**
00,2, 00,5 =
PUR, length 0.2 m or 0.5 m

Wiring diagrams

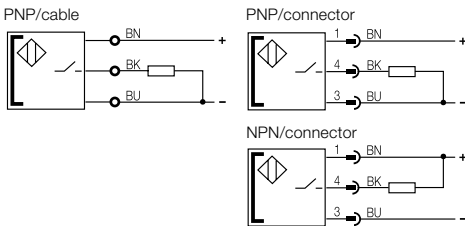

BMF 305 connector for direct connection to distribution box	BMF 305	BMF 305	BMF 305	BMF 305
---	----------------	----------------	----------------	----------------

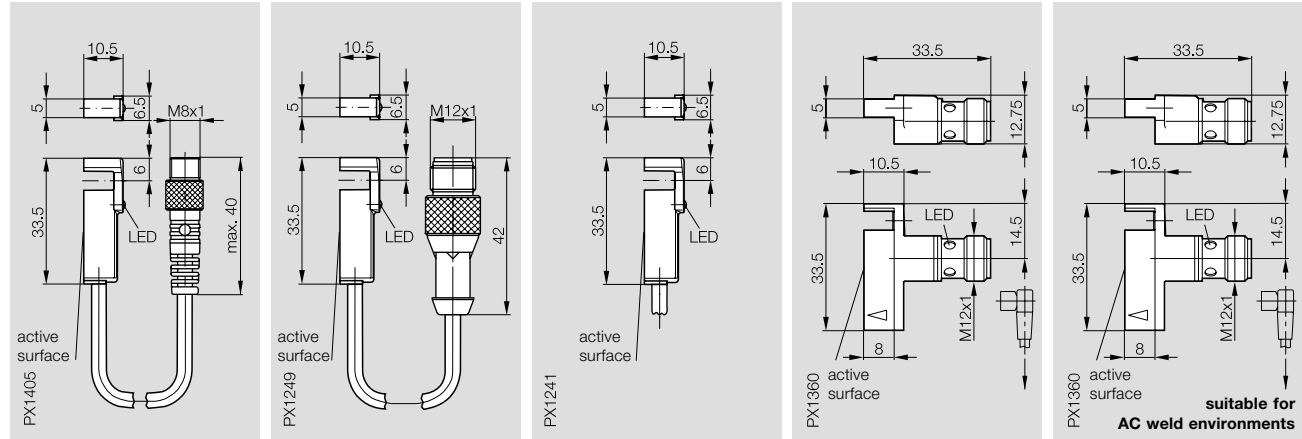

BMF 305K-PS-C-2-SA 2-S49-	BMF 305K-PS-C-2-S 4-	BMF 305K-PS-C-2-	BMF 305M-PS-C-2-S 4	BMF 305M-PS-W-2-S 4
----------------------------------	-----------------------------	-------------------------	----------------------------	----------------------------

1.2 kA/m ≥ 2 kA/m ≤ 45 % ≤ 0.3 %/°C	1.2 kA/m ≥ 2 kA/m ≤ 45 % ≤ 0.3 %/°C	1.2 kA/m ≥ 2 kA/m ≤ 45 % ≤ 0.3 %/°C	1.2 kA/m ≥ 2 kA/m ≤ 45 % ≤ 0.3 %/°C	1.2 kA/m ≥ 2 kA/m ≤ 45 % ≤ 0.3 %/°C
10...30 V DC ≤ 3.1 V 75 V DC 200 mA ≤ 30 mA ≤ 80 µA yes yes ≤ 1 µF -25...+70 °C DC 13 IP 67 LCP cable with connector cULus	10...30 V DC ≤ 3.1 V 75 V DC 200 mA ≤ 30 mA ≤ 80 µA yes yes ≤ 1 µF -25...+70 °C DC 13 IP 67 LCP cable with connector cULus BKS-B 19	10...30 V DC ≤ 3.1 V 75 V DC 200 mA ≤ 30 mA ≤ 80 µA yes yes ≤ 1 µF -25...+70 °C DC 13 IP 67 LCP cable 3 × 0.14 mm ² cULus	10...30 V DC ≤ 3.1 V 75 V DC 200 mA ≤ 30 mA ≤ 80 µA yes yes ≤ 1 µF -25...+70 °C DC 13 IP 67 Al connector cULus BKS-B 19	10...30 V DC ≤ 4 V 75 V DC 200 mA ≤ 30 mA ≤ 80 µA yes yes ≤ 1 µF -25...+70 °C DC 13 IP 67 Al connector cULus BKS-B 19



**stainless steel
1.4571**
special sensor for pneumatic
cylinders in the foods
industry, see page 3.17

3
Brackets
selection guide
page 3.7 ...
Connectors
selection guide
page 3.20 ...

6
Connectors ...
page 6.2 ...



Series	BMF 305	BMF 305

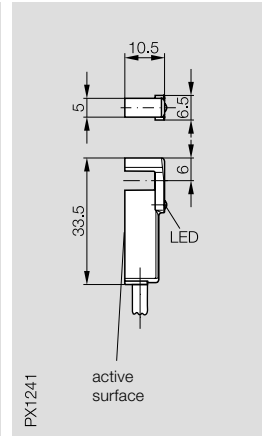
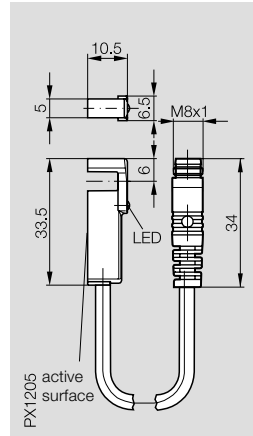

Ordering as a set

Sensor and bracket:
Please include code for bracket
in ordering code
e. g. BMF 305K/**HW20**-R-PS-F-3-03
Magnetic field sensor and bracket
in one part number.

The BMF 305K-R reed switch has an LED for function display and as a setup aid. The recovery diode for switching an inductive load is already integrated.

For sensing the piston position in pneumatic cylinders you can choose between electronic and mechanical cylinder switches. Select whichever one fits your application. We'll be glad to help you.

- Fast and easy to install
- Fits any standard cylinder size using available brackets
- No loss of the switchpoint when replacing a switch

PNP	Normally-open	BMF 305K-R-PS-F-3-S49-	BMF 305K-R-PS-F-3-
Sensed medium		magnetic field	magnetic field
Supply voltage U_B		10...30 V DC	10...30 V DC
Rated operational current I_e		500 mA	500 mA
Load capacity		$\leq 0.5 \mu\text{F}$	$\leq 0.5 \mu\text{F}$
Ambient temperature range T_a		-20...+70 °C	-20...+70 °C
Utilization category		DC 13	DC 13
Degree of protection per IEC 60529		IP 65	IP 65
Housing material		LCP	LCP
Connection		cable with connector	cable
No. of wires x conductor cross section			3 x 0.14 mm ²
Recommended connector		BKS-B 48	

Please add the cable length to the ordering code for sensors with **cable!**
03, 05 = PVC, length 3 m or 5 m

Please add the cable length to the ordering code for sensors with **cable and connector!**
00,2, 00,5 = PUR, length 0.2 m or 0.5 m



Wiring diagrams

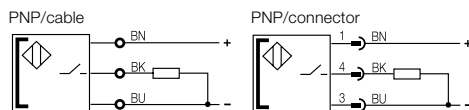

BMF 303-HW-28/30

BMF 303-HW-33

BMF 303-HW-34



Advantages

Sensor disappears in the slot!



Adjust switchpoint in seconds! Turn screw one revolution, adjust position, tighten.



Switchpoint can't be lost. Even if you replace the sensor, the adjusted switchpoint is retained by the bracket.



Ordering code

Advantages

Cylinder slot

Bracket

BMF 303-HW-28



C-slot
e. g. SMC

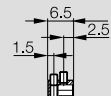
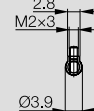

BMF 303-HW-30



C-slot
Festo slot-10

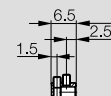
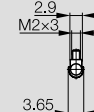
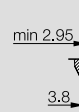

BMF 303-HW-33



T-slot
e. g. Festo, Bosch, SMC

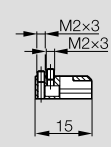
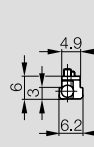
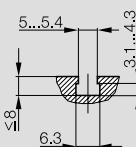

BMF 303-HW-40



T-slot
e. g. Festo, Bosch, SMC

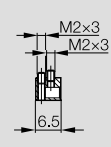
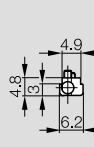
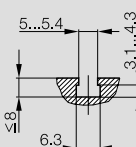

Tube cuffs for BMF 303-HW-34

Piston-Ø	Tube cuff size
< 8	0
8...16	1
20, 25	2
32	3
40	4
50	5
63	6
80	7

Tube cuff size _
please order separately

BMF 303-HW-34



no slot

round cylinder
diameter
< 8...80 mm

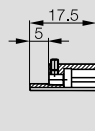
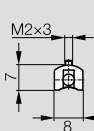

3

Brackets selection guide page 3.7 ...

Connectors selection guide page 3.20 ...

6

Connectors ... page 6.2 ...

BMF 305-HW-20

BMF 305-HW-23

BMF 305-HW-24

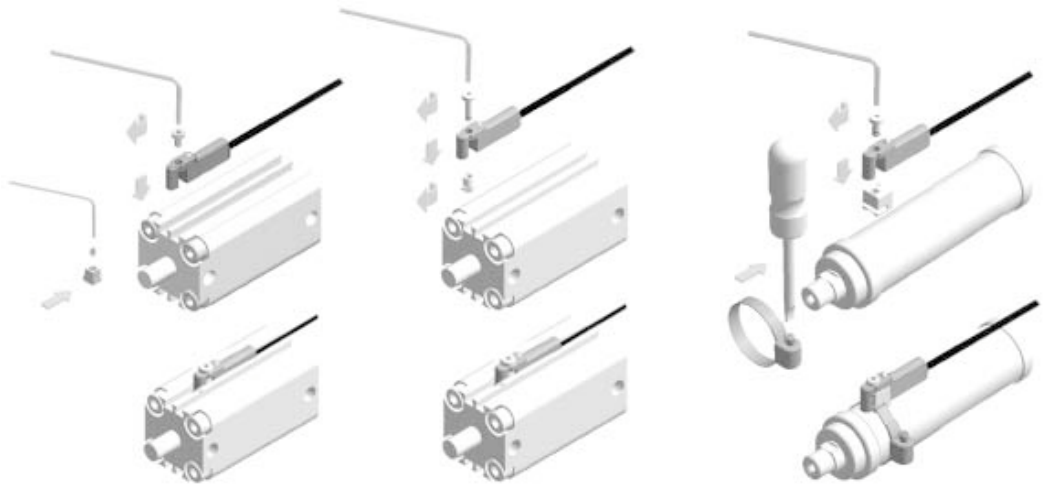

Advantages

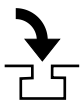

Can be inserted into slot from above. Anytime! Even later! Fast! Time-saving!



Adjust switchpoint in seconds! Turn screw one revolution, adjust position, tighten.



Switchpoint can't be lost. Even if you replace the sensor, the adjusted switchpoint is retained by the bracket.

Ordering code

Advantages

Cylinder slot

Bracket

BMF 305-HW-17



T-slot



e. g. Festo, SMC

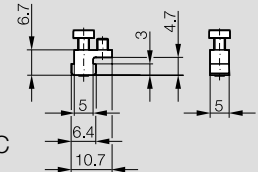

BMF 305-HW-20

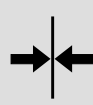

T-slot

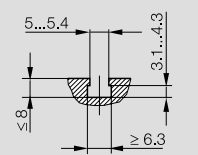

e. g. Festo, SMC

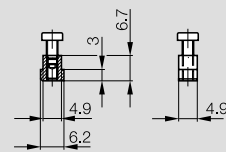

BMF 305-HW-22

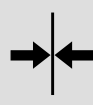

T-slot

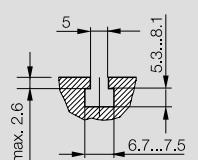

e. g. Festo, Bosch

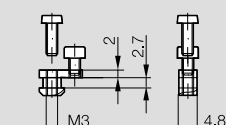

BMF 305-HW-23

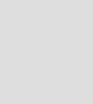

T-slot

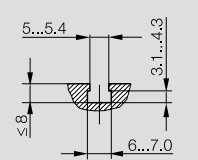

e. g. Festo, SMC

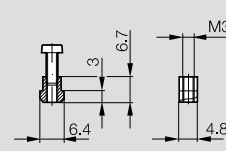

Tube cuffs for BMF 305-HW-24

Piston Ø	Tube cuff size
< 8	0
8...16	1
20, 25	2
32	3
40	4
50	5
63	6
80	7

Tube cuff size _
please order separately

BMF 305-HW-24

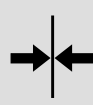

no slot

round cylinder
diameter
< 8...80 mm

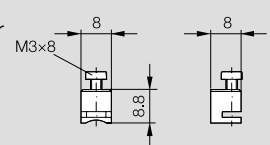

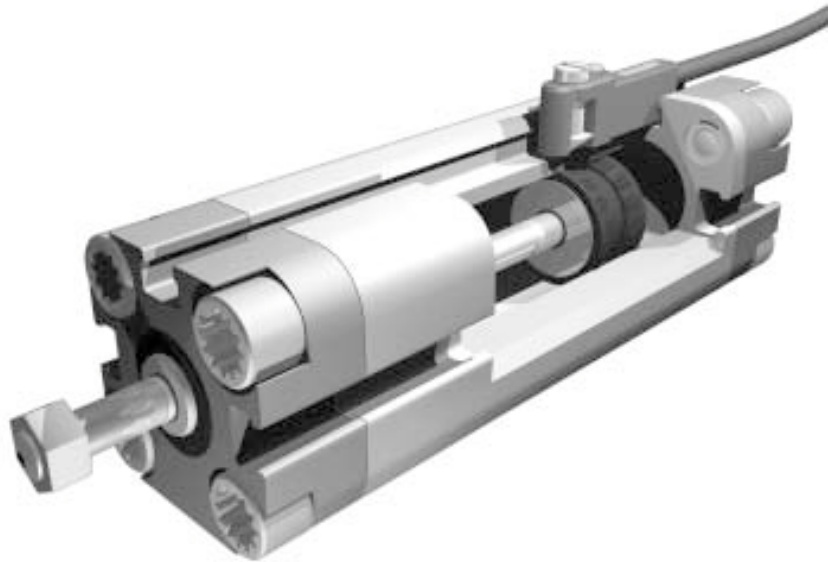

Installation

Included

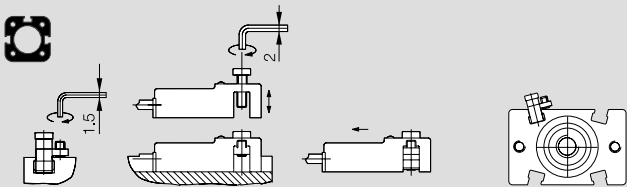

1. Insert bracket into slot from head end
2. Insert sensor from above and tighten
3. Position sensor, tighten bracket

Setscrew DIN 916 M3×5-A2
Screw DIN 7984 M3×10-A2
Bracket

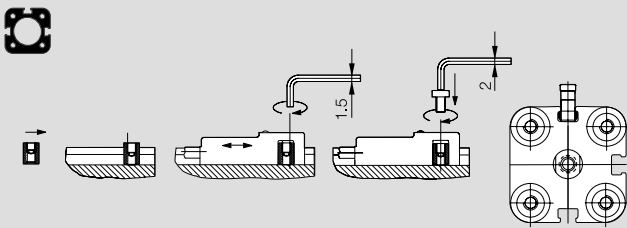

1. Insert bracket into slot from head end
2. Insert sensor from above, position and tighten bracket
3. Tighten down sensor with bracket

Setscrew DIN 916 M3×4-A2
Screw ISO 1207 M3×6-A2
Bracket
also:
Screw DIN 7984 M3×6-A2

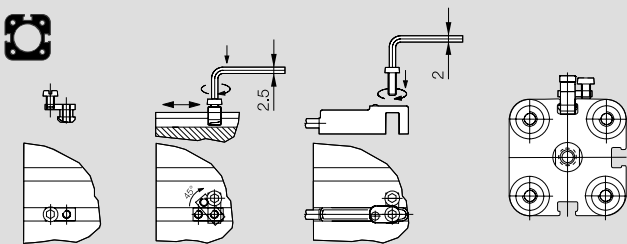

1. Insert bracket into slot from above, rotate 90°
2. Insert sensor from above and tighten
3. Position sensor, tighten bracket

Screw DIN 912 M3×4-A2
Screw DIN 7984 M3×8-A2
Bracket
also:
Screw ISO 1207 M3×4-A2
Screw ISO 1207 M3×8-A2

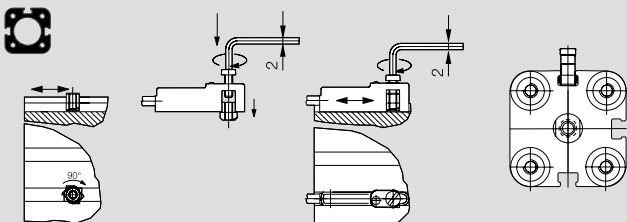

1. Attach bracket to sensor with 1 to 2 turns
2. Insert sensor and bracket from above and tighten (bracket rotates by 90°)

Screw DIN 7984-KL M3×10-A2
Bracket
also:
Screw ISO 1207-KL M3×10-A2

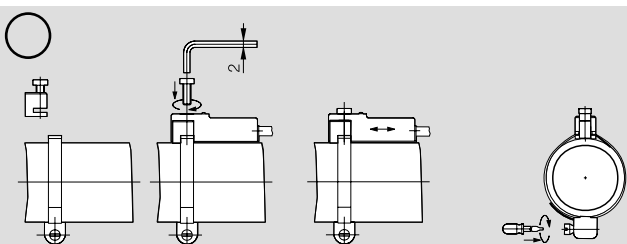

1. Place tube cuff on loosely
2. Attach sensor with bracket to tube cuff
3. Position and tighten

Screw DIN 7984 M3×8-A2
Bracket

Tube cuff size _ please order separately (see table at left)

Advantages

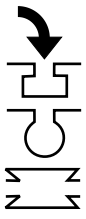

Can be inserted into slot from above. Anytime! Even later! Fast! Time-saving!



Adjust switchpoint in seconds! Turn screw one revolution, adjust position, tighten.



Switchpoint can't be lost. Even if you replace the sensor, the adjusted switchpoint is retained by the bracket.

Ordering code

Advantages

Cylinder slot

Bracket

BMF 305-HW-25

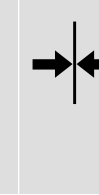

trapezoidal slot 60°/90°

e. g. Festo, Bosch, Numatics, Hoerbiger-Origa, Norgren-Martonair

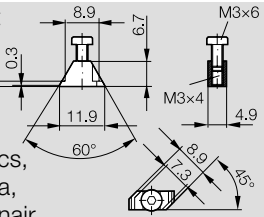

BMF 305-HW-26

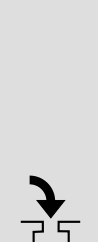

T-slot A

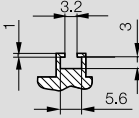

T-slot B

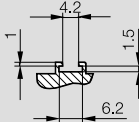

e.g. SMC

position for T-slot A

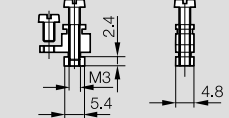

position for T-slot B

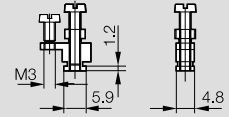

BMF 305-HW-27

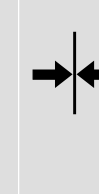

trapezoidal guide



e. g. Bosch

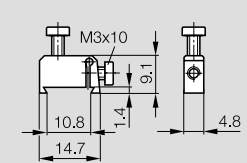

BMF 305-HW-32

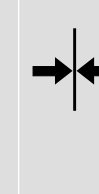

C-slot

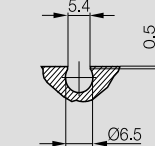

e. g. Norgren

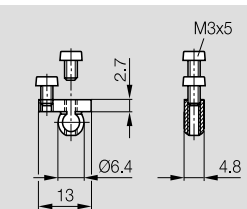

BMF 305-HW-21 together with BMF 21-HW-8



BMF 305-HW-21

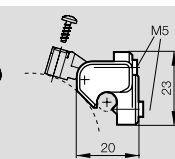

BMF 21-HW-8

BMF 305-HW-21 together with BMF 21-HW-10



BMF 305-HW-21

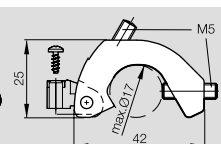

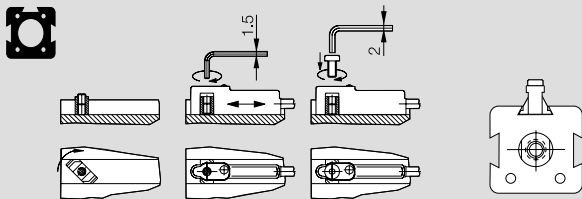

Installation

1. Insert bracket from above and rotate 90°
2. Insert sensor, position, tighten bracket
3. Tighten down sensor with bracket

Included

Setscrew DIN 916 M3×4-A2
Screw DIN 7984 M3×6-A2
Bracket

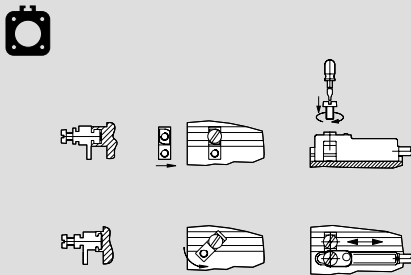

The bracket can be used for two slot dimensions.

T-slot **A**: insert bracket, insert sensor from above, position and tighten both screws.

T-slot **B**: insert bracket from above and rotate 90°. Insert sensor from above, position and tighten both screws.

Cheese head screw ISO 1207 M3×5 A2
Cheese head screw ISO 1207 M3×14 A2
Bracket

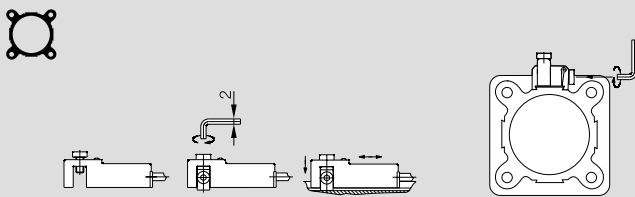

1. Insert bracket from above
2. Insert sensor from above and tighten
3. Position sensor, tighten bracket

Screw DIN 912 M3×4-A2
Screw DIN 7984 M3×10-A2
Bracket

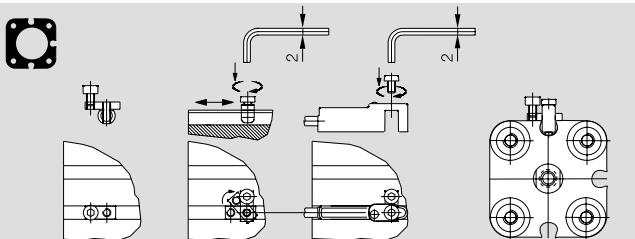

1. Insert bracket from above and rotate 90°
2. Insert sensor, position, tighten bracket
3. Tighten down sensor with bracket

Screws DIN 7984 M3×5-A2
Bracket

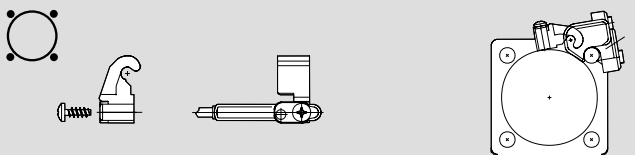

BMF 305-HW-21 together with BMF 21-HW-8 for installation on a tie rod cylinder

PT-screw KBL 30x8-A2
Bracket BMF 305-HW-21 (bracket BMF 21-HW-8 please order separately)

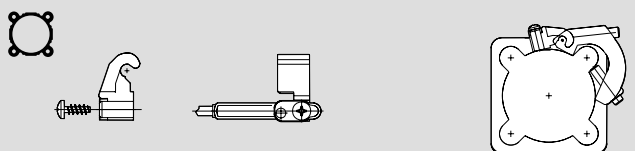

BMF 305-HW-21 together with BMF 21-HW-10 for installation on an profile cylinder

PT-screw KBL 30x8-A2
Bracket BMF 305-HW-21 (bracket BMF 21-HW-10 please order separately)