

# GIM500R - 2-dimensional

 2-dimensional, measuring range up to  $\pm 90^\circ$ 

CANopen® / SAE J1939 / Analog

## Overview

- Size 52 mm
- MEMS capacitive measuring principle
- E1 compliant design
- Interface CANopen®, SAE J1939, Analog
- Connection M12 and cable
- Protection up to IP 69K
- Applicable up to PLd (ISO 13849)



## Technical data

### Technical data - electrical ratings

Voltage supply	8...36 VDC
Reverse polarity protection	Yes
Consumption w/o load	$\leq 40$ mA (24 VDC)
Initializing time	$\leq 0,5$ s after power on
Interface	CANopen® SAE J1939 Analog (4...20 mA / 0.5...4.5 V / 0...5 V / 0...10 V)
Load resistor	$\geq 1$ k $\Omega$ / voltage output $\leq 800$ $\Omega$ / current output
Measuring range	$\pm 10^\circ / \pm 30^\circ / \pm 45^\circ / \pm 60^\circ / \pm 90^\circ$
Resolution	0,01 ° CANopen® 0,01 ° SAE J1939 12 bit Analog
Accuracy (+25 °C)	Typ. $\pm 0,1^\circ$
Temperature coefficient	0,008 °/K
Cross-axis-sensitivity typ.	0.3 %
Repeatability	$\pm 0,1^\circ$ (+25 °C)
Sensing rate	1600 Hz
Limit frequency	0.1...25 Hz, 2. order / low-pass filter (Default: 5 Hz)
Interference immunity	EN 61000-6-2 ECE Reg. No. 10R04 ISO 7637-2 ISO 11452-2 / ISO 11452-5
Emitted interference	EN 61000-6-4 ECE Reg. No. 10R04 ISO 7637-2 / EN 55025

### Technical data - electrical ratings

MTTF <sub>d</sub> (ISO 13849)	High (>100 years) Use in safety functions exclusively based on Application Note and MTTF <sub>d</sub> reliability prediction (request separately).
Programmable parameters	Preset and offset Filter
Diagnostic function	Parameter error
Status indicator	DUO-LED integrated in housing
Approval	UL approval / E63076

### Technical data - mechanical design

Dimensions W x H x L	48 x 24 x 52 mm
Protection EN 60529	IP 66 IP 67 IP 68 IP 69K
Material	Housing: aluminium, coated
Corrosion protection	IEC 60068-2-52 Salt mist for ambient conditions CX (C5-M) according to ISO 12944-2
Operating temperature	-40...+85 °C (see general information)
Resistance	EN 60068-2-6 Vibration 20 g, 60...2000 Hz EN 60068-2-27 Shock 200 g, 6 ms
Weight approx.	95 g
Connection	Flange connector M12, 8-pin Flange connector M12, 5-pin Cable 1 m

## Optional

- With integrated terminating resistor
- Connection with DEUTSCH connector
- Output signal with out-of-range diagnostics

## GIM500R - 2-dimensional

2-dimensional, measuring range up to  $\pm 90^\circ$

CANopen® / SAE J1939 / Analog

### General information

Self-heating correlated to installation and ambient conditions as well as to electronics and supply voltage must be considered for precise thermal dimensioning. The inclination sensor is supposed to self-heat to approximately 5 K when attached to a varnished ground metal. Operating the inclination sensor close to the maximum limits requires measuring the currently prevailing temperature at the housing. Vibration with frequency in the range of 1600 Hz acting on the sensor leads to reduced measuring accuracy.

### Installation position

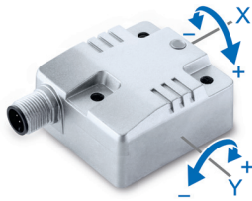

#### Horizontal installation

When installing the 2-dimensional inclination sensor with the housing in horizontal position, make sure the base plate is aligned parallel to the horizontal line.

The sensor can be inclined both towards the X and the Y axis. There is one measured value supplied for each axis. Sensor default is 2-dimensional measuring within the selected range, e.g.  $\pm 30^\circ$ . Zero-crossing is exact in the horizontal line.

$y = 0^\circ$



$y = -30^\circ$



$x = 0^\circ$



$x = +30^\circ$

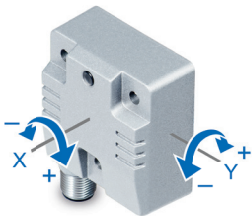

#### Vertical installation

When installing the 2-dimensional inclination sensor with the housing in vertical position, make sure the base plate is aligned parallel to the vertical line. The sensor can be inclined both towards the X and the Y axis. There is one measured value supplied for each axis.

Sensor default is 2-dimensional measuring within the selected range, e.g.  $\pm 30^\circ$ . Zero-crossing is exactly in the vertical line.

$y = 0^\circ$



$y = -30^\circ$



$x = 0^\circ$



$x = +30^\circ$



# GIM500R - 2-dimensional

2-dimensional, measuring range up to  $\pm 90^\circ$

CANopen® / SAE J1939 / Analog

## Terminal assignment

### Analog – M12 flange connector, 8-pin

Pin	Assignment	Description
1	+Vs	Voltage supply
2	GND	Ground connection relating to +Vs
3	OUT_X	Output
4	OUT_Y	Output
5	Teach <sup>1)</sup>	Teach-Input
6	d.u.	Do not use
7	d.u.	Do not use
8	A_GND	Ground connection relating to analog

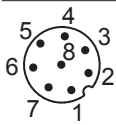

M12 flange connector (male),  
A-coded

### Analog – cable

Core color	Assignment	Description
White	+Vs	Voltage supply
Brown	GND	Ground connection relating to +Vs
Green	OUT_X	Output
Yellow	OUT_Y	Output
Grey	Teach <sup>1)</sup>	Teach-Input
Pink	d.u.	Do not use
Blue	d.u.	Do not use
Red	A_GND	Ground connection relating to analog

<sup>1)</sup> Function zero setting  
See description zero setting

### CANopen® / SAE J1939 – M12 flange connector, 5-pin

Pin	Assignment	Description
1	CAN_GND	Ground connection relating to CAN
2	+Vs	Voltage supply
3	GND	Ground connection relating to +Vs
4	CAN_H	CAN Bus Signal (dominant High)
5	CAN_L	CAN Bus Signal (dominant Low)

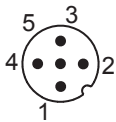

M12 flange connector (male),  
A-coded

## Terminal assignment

### CANopen® / SAE J1939 – 2xM12 flange connector, 5-pin

Pin	Assignment	Description
1	CAN_GND	Ground connection relating to CAN
2	+Vs	Voltage supply
3	GND	Ground connection relating to +Vs
4	CAN_H	CAN Bus Signal (dominant High)
5	CAN_L	CAN Bus Signal (dominant Low)

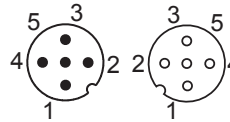

M12 flange connector (male / female),  
A-coded

Terminals of the same significance are internally connected and identical in their functions. Max. load on the internal terminal connections Vs-Vs and GND-GND is 1 A each.

### CANopen® – Cable

Core color	Assignment	Description
White	+Vs	Voltage supply
Brown	GND	Ground connection relating to +Vs
Green	d.u.	–
Yellow	d.u.	–
Grey	d.u.	–
Pink	CAN_H	CAN Bus Signal (dominant High)
Blue	CAN_L	CAN Bus Signal (dominant Low)
Red	CAN_GND	Ground connection relating to CAN

## CANopen® features

Bus protocol	CANopen®
Device profile	CANopen® - CiA DSP 301 V4.2 Inclinometer profile DS 410 V1.3 LSS service profile DS 305 V2.2
Default	Resolution 0.1° Baud rate 50 kbit/s Node ID 1

# GIM500R - 2-dimensional

2-dimensional, measuring range up to  $\pm 90^\circ$

CANopen® / SAE J1939 / Analog

## Output signals

### Analog output

#### Measuring range $\pm 30^\circ$ / Mounting position horizontal

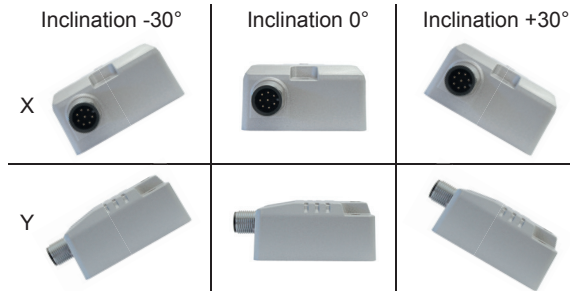
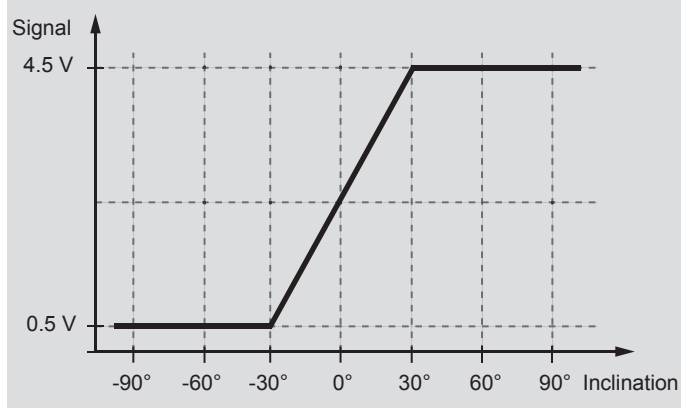

## Output signals

#### Measuring range $\pm 90^\circ$ / Mounting position horizontal

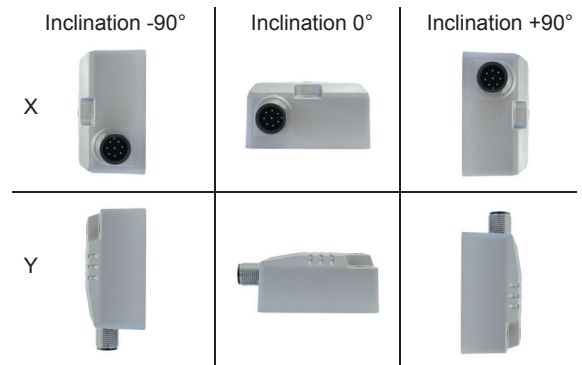
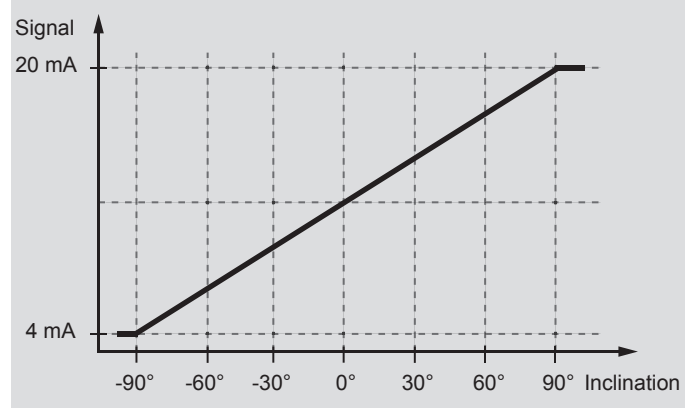

#### Measuring range $\pm 60^\circ$ / Mounting position vertical

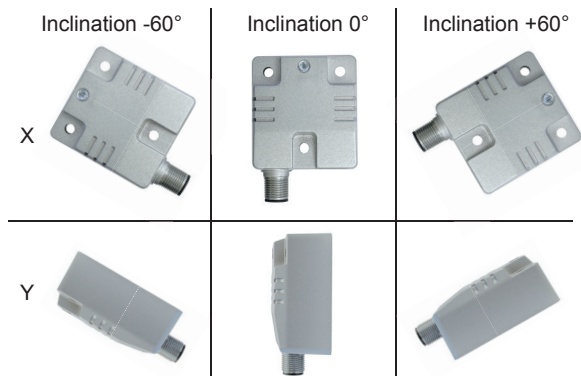
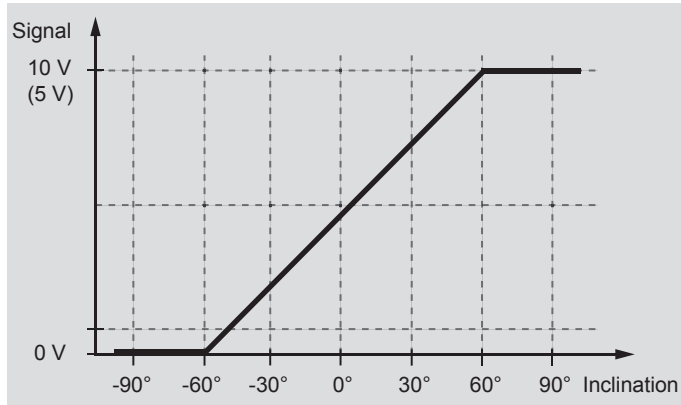

# GIM500R - 2-dimensional

2-dimensional, measuring range up to  $\pm 90^\circ$

CANopen® / SAE J1939 / Analog

## Output signals

Analog output with out-of-range diagnostic (Option: /4822)

Measuring range  $\pm 30^\circ$  / Mounting position horizontal

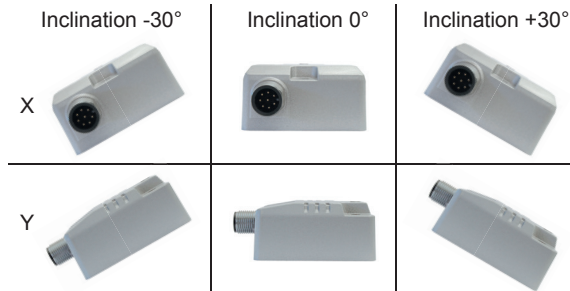
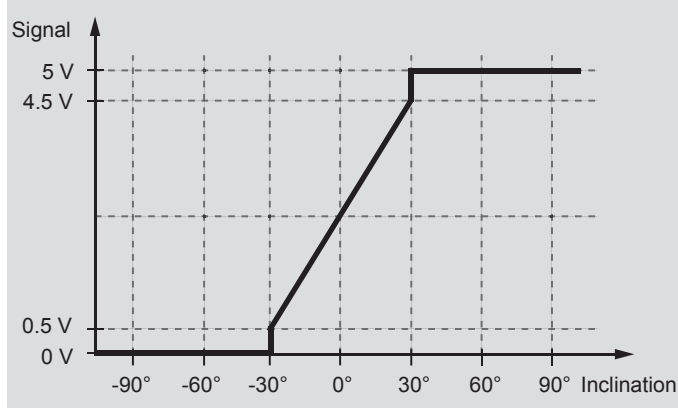

Measuring range  $\pm 60^\circ$  / Mounting position vertical

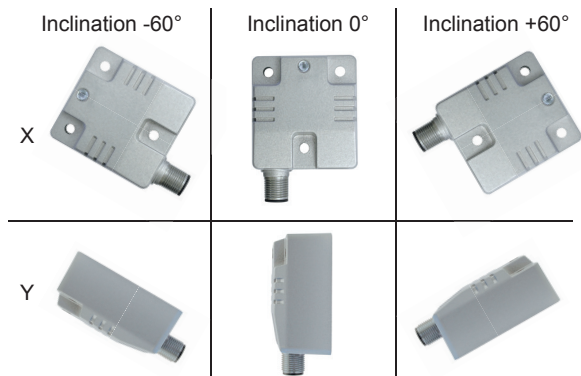
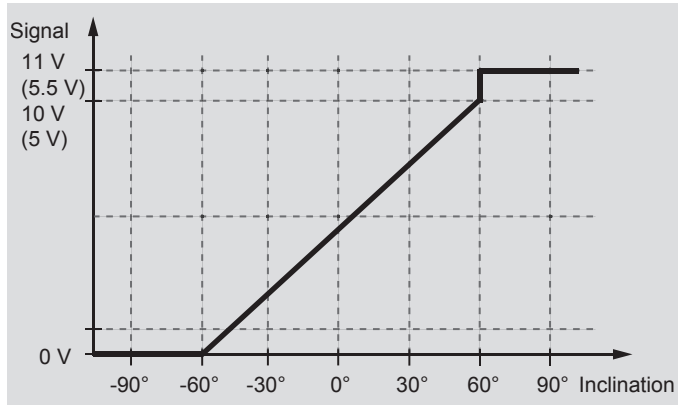

## Output signals

Measuring range  $\pm 90^\circ$  / Mounting position horizontal

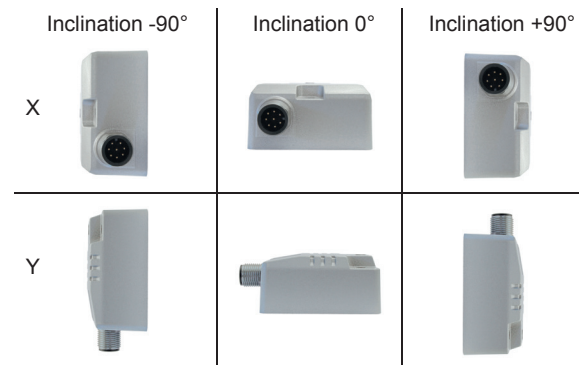
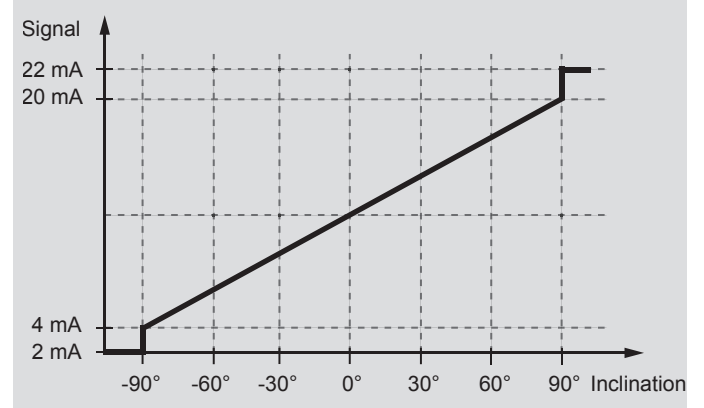

## Zero setting

Set Teach input for  $>250$  ms on HIGH level ( $\geq 0.7 \cdot +V_s$ ) conforms inclination  $0^\circ$ . Zero setting affects both axes (X/Y).

# GIM500R - 2-dimensional

2-dimensional, measuring range up to  $\pm 90^\circ$

CANopen® / SAE J1939 / Analog

## Dimensions

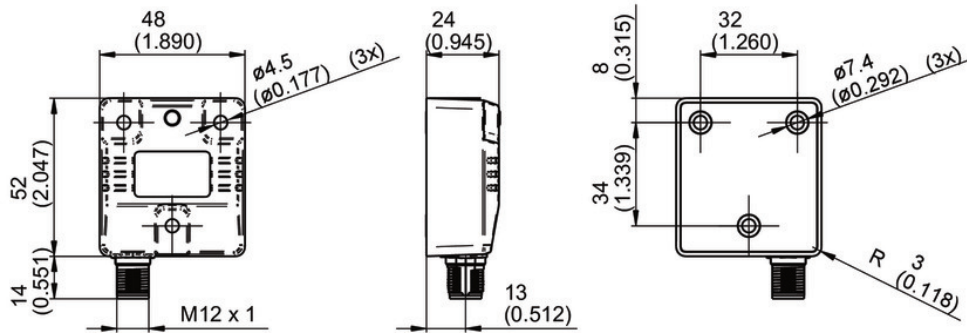

GIM500R - 1 x connector M12

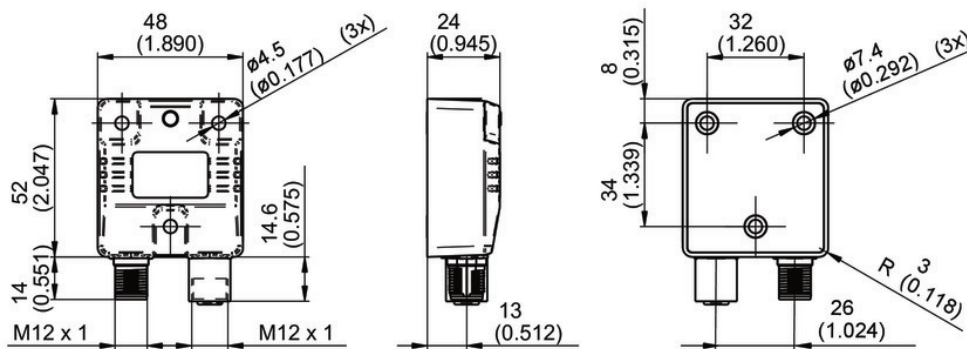

GIM500R - 2 x connector M12

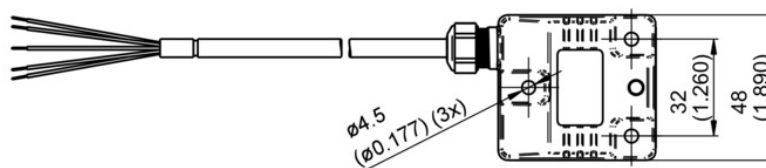
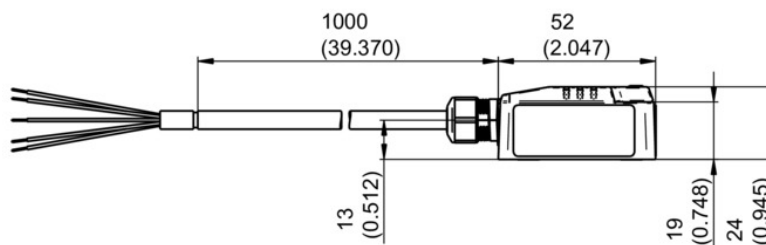
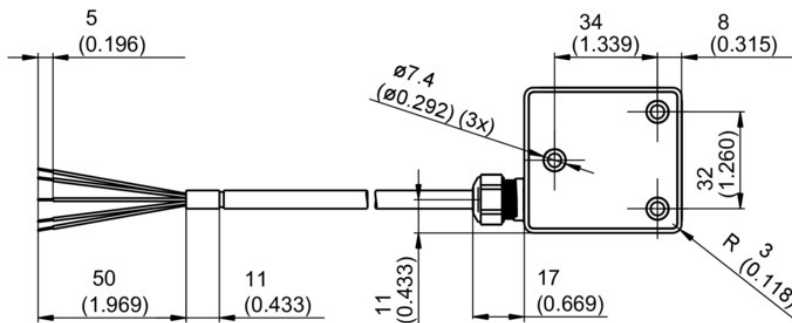

GIM500R - cable

# GIM500R - 2-dimensional

 2-dimensional, measuring range up to  $\pm 90^\circ$ 

CANopen® / SAE J1939 / Analog

## Ordering reference

	GIM500R	-	M	#	###	.	#	##	.	A	#####
<b>Product</b>	GIM500R										
<b>Housing</b>											
Metal			M								
<b>Number of axes</b>											
2-dimensional, housing horizontal				2							
2-dimensional, housing vertical				V							
<b>Measuring range</b>											
$\pm 10^\circ$ (Analog with zero setting)					10						
$\pm 30^\circ$ (Analog with zero setting)					30						
$\pm 45^\circ$ (Analog with zero setting)					45						
$\pm 60^\circ$ (Analog with zero setting)					60						
$\pm 90^\circ$ (Analog, CANopen®, SAE J1939)					90						
<b>Connection</b>											
Cable 1 m, Standard 4x2x0.14 mm <sup>2</sup> (Analog, CANopen®, SAE J1939)									K		
Flange connector M12, 5-pin, male contacts (CANopen®, SAE J1939)									A		
Flange connector 2xM12, 5-pin, male and female contacts (CANopen®, SAE J1939)									B		
Flange connector M12, 8-pin, male contact (Analog)									F		
<b>Voltage supply / interface</b>											
8...36 VDC / CANopen®										C6	
8...36 VDC / SAE J1939										C9	
8...36 VDC / Analog 0.5...4.5 V										V4	
8...36 VDC / Analog 0...5 V										V5	
8...36 VDC / Analog 0...10 V										V1	
8...36 VDC / Analog 4...20 mA										C4	
<b>Operating temperature</b>											
-40...+85 °C										A	
<b>Option</b>											
Without option											
With integrated terminating resistor (CANopen, SAE J1939)											/4816
Output signal with out-of-range diagnostics (Analog)											/4822

## Accessories

### Mounting accessories

11120131	Mounting kit 3x M4 x 25 DIN912, A 4.3 DIN125
11189609	Mounting kit 3x M4 x 50 DIN912, A 4.3 DIN125, spacers

### Connectors and cables

10127844	Connection cable 2 m shielded with female connector M12, 8-pin, straight (ESG 34FH0200G)
10129332	Connection cable 5 m shielded with female connector M12, 8-pin, straight (ESG 34FH0500G)
10129333	Connection cable 10 m shielded with female connector M12, 8-pin, straight (ESG 34FH1000G)