



PNOZ s8

► Safety relays

PILZ
THE SPIRIT OF SAFETY

This document is the original document.

All rights to this documentation are reserved by Pilz GmbH & Co. KG. Copies may be made for the user's internal purposes. Suggestions and comments for improving this documentation will be gratefully received.

Source code from third-party manufacturers or open source software has been used for some components. The relevant licence information is available on the Internet on the Pilz homepage.

Pilz®, PIT®, PMI®, PNOZ®, Primo®, PSEN®, PSS®, PVIS®, SafetyBUS p®, SafetyEYE®, SafetyNET p®, the spirit of safety® are registered and protected trademarks of Pilz GmbH & Co. KG in some countries.



SD means Secure Digital

Introduction	5
Validity of documentation	5
Using the documentation	5
Definition of symbols	5
Safety	6
Intended use	6
Safety regulations	6
Safety assessment	6
Use of qualified personnel	7
Warranty and liability	7
Disposal	7
For your safety	7
Unit features	8
Safety features	8
Block diagram/terminal configuration	8
Function description	9
Timing diagram	9
Installation	9
Wiring	10
Preparing for operation	10
Operation	11
Status indicators	12
Error indicators	12
Faults - malfunctions	12
Dimensions in mm	12
Technical details	13
Safety characteristic data	16
Supplementary data	17
Service life table	17
Permitted operating height	18

Remove plug-in terminals	19
Order reference	19
EC declaration of conformity	19

Introduction

Validity of documentation

This documentation is valid for the product PNOZ s8. It is valid until new documentation is published.

This operating manual explains the function and operation, describes the installation and provides guidelines on how to connect the product.

Using the documentation

This document is intended for instruction. Only install and commission the product if you have read and understood this document. The document should be retained for future reference.

Definition of symbols

Information that is particularly important is identified as follows:



DANGER!

This warning must be heeded! It warns of a hazardous situation that poses an immediate threat of serious injury and death and indicates preventive measures that can be taken.



WARNING!

This warning must be heeded! It warns of a hazardous situation that could lead to serious injury and death and indicates preventive measures that can be taken.



CAUTION!

This refers to a hazard that can lead to a less serious or minor injury plus material damage, and also provides information on preventive measures that can be taken.



NOTICE

This describes a situation in which the product or devices could be damaged and also provides information on preventive measures that can be taken. It also highlights areas within the text that are of particular importance.

**INFORMATION**

This gives advice on applications and provides information on special features.

Safety**Intended use**

The contact expansion module PNOZ s8 meets the requirements of EN 60947-5-1, EN 60204-1 and VDE 0113-1. It is used to increase the number of safety contacts available on a base unit. Base units are all safety relays with feedback loop.

The max. achievable safety level depends on the base unit. The expansion module may not exceed this. The safety-related characteristic values stated under [Safety-related characteristic data](#) [ 16] can only be achieved if the base unit also exhibits these values.

The following is deemed improper use in particular

- ▶ Any component, technical or electrical modification to the product,
- ▶ Use of the product outside the areas described in this manual,
- ▶ Use of the product outside the technical details (see [Technical details](#) [ 13]).

**NOTICE****EMC-compliant electrical installation**

The product is designed for use in an industrial environment. The product may cause interference if installed in other environments. If installed in other environments, measures should be taken to comply with the applicable standards and directives for the respective installation site with regard to interference.

Safety regulations**Safety assessment**

Before using a device it is necessary to perform a safety assessment in accordance with the Machinery Directive.

Functional safety is guaranteed for the product as a single component. However, this does not guarantee the functional safety of the overall plant/machine. In order to achieve the required safety level for the overall plant/machine, define the safety requirements for the plant/machine and then define how these must be implemented from a technical and organisational standpoint.

Use of qualified personnel

The products may only be assembled, installed, programmed, commissioned, operated, maintained and decommissioned by competent persons.

A competent person is a qualified and knowledgeable person who, because of their training, experience and current professional activity, has the specialist knowledge required. To be able to inspect, assess and operate devices, systems and machines, the person has to be informed of the state of the art and the applicable national, European and international laws, directives and standards.

It is the company's responsibility only to employ personnel who

- ▶ Are familiar with the basic regulations concerning health and safety / accident prevention,
- ▶ Have read and understood the information provided in the section entitled Safety
- ▶ Have a good knowledge of the generic and specialist standards applicable to the specific application.

Warranty and liability

All claims to warranty and liability will be rendered invalid if

- ▶ The product was used contrary to the purpose for which it is intended,
- ▶ Damage can be attributed to not having followed the guidelines in the manual,
- ▶ Operating personnel are not suitably qualified,
- ▶ Any type of modification has been made (e.g. exchanging components on the PCB boards, soldering work etc.).

Disposal

- ▶ In safety-related applications, please comply with the mission time T_M in the safety-related characteristic data.
- ▶ When decommissioning, please comply with local regulations regarding the disposal of electronic devices (e.g. Electrical and Electronic Equipment Act).

For your safety

The unit meets all the necessary conditions for safe operation. However, please note the following:

- ▶ Note for overvoltage category III: If voltages higher than low voltage (>50 VAC or >120 VDC) are present on the unit, connected control elements and sensors must have a rated insulation voltage of at least 250 V.

Unit features

- ▶ Relay outputs:
 - 2 safety contacts (N/O), instantaneous
- ▶ 1 semiconductor output
- ▶ LED for:
 - Input status, channel 1
 - Input status, channel 2
 - Switch status of the safety contacts
 - Fault
- ▶ Plug-in connection terminals (either spring-loaded terminal or screw terminal)
- ▶ See order reference for unit types

Safety features

The unit meets the following safety requirements:

- ▶ The unit monitors its own output contacts.
- ▶ The safety function remains effective in the case of a component failure.
- ▶ Earth fault in the feedback loop:
Detected, depending on the base unit that is used.
- ▶ Earth fault in the input circuit:
The output relays de-energise and the safety contacts open.

Block diagram/terminal configuration

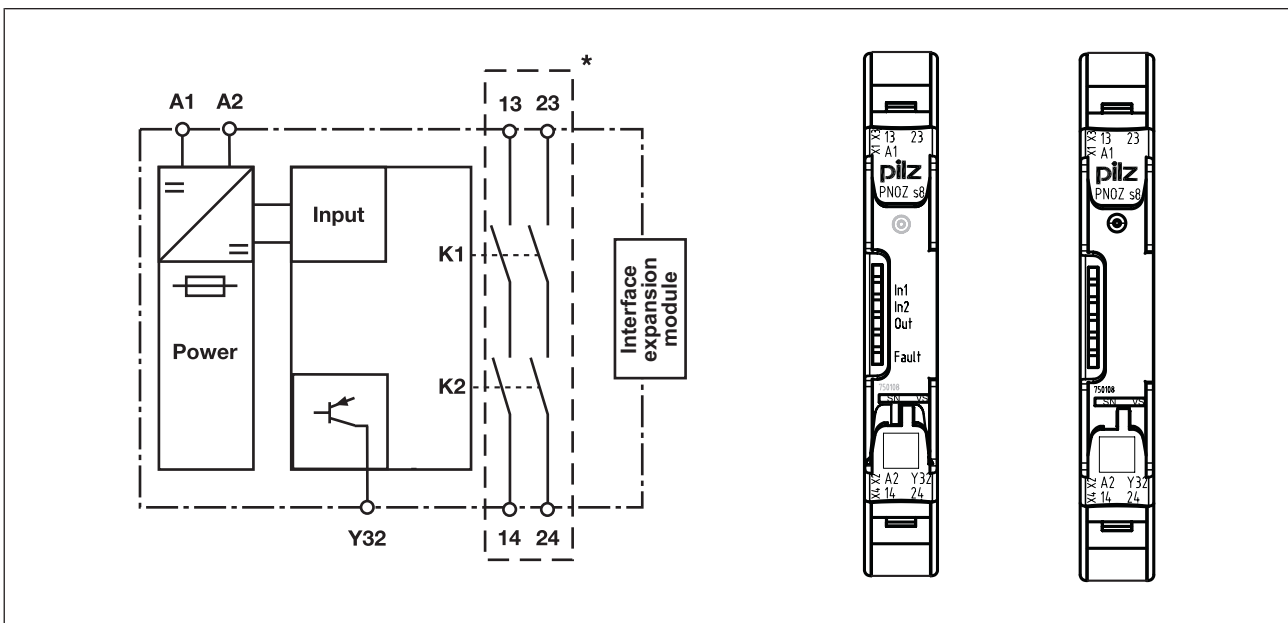

Fig.: Centre: Front view with cover, right: Front view without cover

*Safe separation from non-marked area in accordance with EN 60947-1, 6 kV, basic insulation between all safety contacts.

Function description

with PNOZsigma base unit:

- ▶ Dual-channel operation via PNOZsigma connector

without PNOZsigma base unit:

- ▶ Single-channel operation: one input circuit affects the output relays

Timing diagram

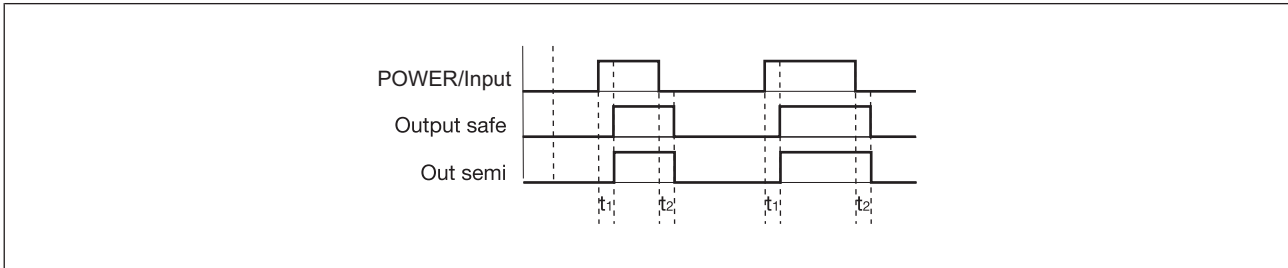

Legend

- ▶ POWER/Input: Supply voltage/input
- ▶ Output safe: Safety contacts
- ▶ Out semi: Semiconductor output
- ▶ t_1 : Switch-on delay
- ▶ t_2 : Delay-on de-energisation

Installation

Install contact expansion module without base unit:

- ▶ Ensure that the plug terminator is inserted at the side of the unit.

Connect base unit and PNOZsigma contact expansion module:

- ▶ Remove the plug terminator at the side of the base unit and at the contact expander module
- ▶ Connect the base unit and the contact expansion module using the connector supplied, before mounting the units to the DIN rail.

Control cabinet installation

- ▶ The safety relay should be installed in a control cabinet with a protection type of at least IP54.
- ▶ Use the notch on the rear of the unit to attach it to a DIN rail (35 mm).
- ▶ When installed vertically: Secure the unit by using a fixing element (e.g. retaining bracket or end angle).
- ▶ Push the unit upwards or downwards before lifting it from the DIN rail.

Wiring

Please note:

- ▶ Information given in the "Technical details [13]" must be followed.
- ▶ Outputs 13-14 and 23-24 are safety contacts, the semiconductor output Y32 is an auxiliary output (e.g. for display).
- ▶ Semiconductor output Y32 should **not** be used for safety circuits!
- ▶ To prevent contact welding, a fuse should be connected before the output contacts (see Technical details [13]).
- ▶ Calculation of the max. cable length l_{max} in the input circuit:

$$l_{max} = \frac{R_{lmax}}{R_l / km}$$

R_{lmax} = max. overall cable resistance (see Technical details [13])

R_l / km = cable resistance/km

- ▶ Use copper wire that can withstand 60/75 °C.
- ▶ Sufficient fuse protection must be provided on all output contacts with capacitive and inductive loads.
- ▶ Ensure the wiring and EMC requirements of EN 60204-1 are met.
- ▶ The power supply must comply with the regulations for extra low voltages with protective electrical separation (SELV, PELV) in accordance with VDE 0100, Part 410.

Preparing for operation

Supply voltage	AC	DC
Input circuit	Single-channel	Dual-channel
Base unit: Safety relay PNOZ X		
Base unit: Safety relay PNOZelog Driven via semiconductor outputs (24 VDC)		

Feedback loop

- ▶ **with PNOZsigma base unit:**
The feedback loop is connected and evaluated via the connector.
- ▶ **without PNOZsigma base unit:**
Feedback loop does not need to be monitored because the contact expansion block monitors its own output contacts.

Semiconductor output

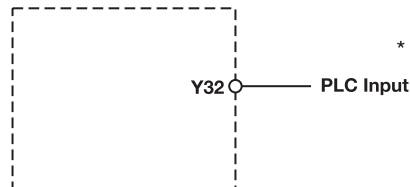

*Connect together the 0V connections on all the external power supplies



INFORMATION

If a base unit and a contact expansion module from the PNOZsigma range are linked via the connector, no additional wiring is necessary. Do not connect A1 to the contact expansion module!

Operation

When the relay outputs are switched on, the mechanical contact on the relay cannot be tested automatically. Depending on the operational environment, measures to detect the non-opening of switching elements may be required under some circumstances.

When the product is used in accordance with the European Machinery Directive, a check must be carried out to ensure that the safety contacts on the relay outputs open correctly. Open the safety contacts (switch off output) and start the device again for SIL CL 2/PL c at least 1 x per year, so that the internal diagnostics can check that the safety contacts open correctly.



NOTICE

The safety function should be checked after initial commissioning and each time the plant/machine is changed. The safety functions may only be checked by qualified personnel.

LEDs indicate the status and errors during operation:



LED on



LED flashes

Status indicators

- ☀ **IN1**
Channel 1 actuated.
- ☀ **IN2**
Channel 2 actuated.
- ☀ **IN1, IN2, OUT**
Safety contacts are closed.

Error indicators

- **FAULT**
Diagnostics: Internal error, unit defective
 - ▶ Remedy: Switch supply voltage off and then on again, change unit if necessary.

Faults - malfunctions

- ▶ Contact malfunctions: If the contacts have welded, reactivation will not be possible after the input circuit has opened.

Dimensions in mm

*with spring-loaded terminals

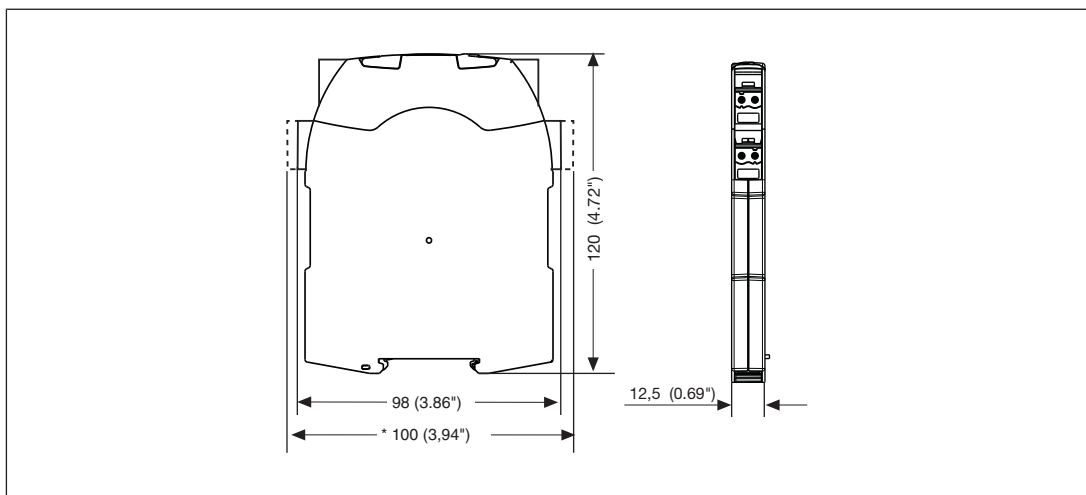

Technical details

General	750108	751108
Approvals	CCC, CE, EAC (Eurasian), KOSHA, TÜV, cULus Listed	CCC, CE, EAC (Eurasian), KOSHA, TÜV, cULus Listed
Electrical data	750108	751108
Supply voltage		
Voltage	24 V	24 V
Kind	DC	DC
Voltage tolerance	-20 %/+20 %	-20 %/+20 %
Output of external power supply (DC)	2 W	2 W
Residual ripple DC	20 %	20 %
Duty cycle	100 %	100 %
Inputs	750108	751108
Number	1	1
Voltage at		
Input circuit DC	24 V	24 V
Current at		
Input circuit DC	65 mA	65 mA
Max. inrush current impulse		
Current pulse, input circuit	0,6 A	0,6 A
Pulse duration, input circuit	15 ms	15 ms
Max. overall cable resistance R _{I-max}		
Single-channel at UB DC	30 Ohm	30 Ohm
Semiconductor outputs	750108	751108
Number	1	1
Voltage	24 V	24 V
Current	20 mA	20 mA
Relay outputs	750108	751108
Number of output contacts		
Safety contacts (N/O), instantaneous	2	2
Max. short circuit current I _K	1 kA	1 kA
Utilisation category		
In accordance with the standard	EN 60947-4-1	EN 60947-4-1

Relay outputs	750108	751108
Utilisation category of safety contacts		
AC1 at	240 V	240 V
Min. current	0,02 A	0,02 A
Max. current	3 A	3 A
Max. power	720 VA	720 VA
DC1 at	24 V	24 V
Min. current	0,02 A	0,02 A
Max. current	3 A	3 A
Max. power	72 W	72 W
Utilisation category		
In accordance with the standard	EN 60947-5-1	EN 60947-5-1
Utilisation category of safety contacts		
AC15 at	230 V	230 V
Max. current	1,5 A	1,5 A
DC13 (6 cycles/min) at	24 V	24 V
Max. current	1,5 A	1,5 A
Utilisation category in accordance with UL		
Voltage	240 V AC G. P.	240 V AC G. P.
With current	3 A	3 A
Voltage	24 V DC G. P.	24 V DC G. P.
With current	3 A	3 A
Pilot Duty	B300, R300	B300, R300
External contact fuse protection, safety contacts		
In accordance with the standard	EN 60947-5-1	EN 60947-5-1
Blow-out fuse, quick	4 A	4 A
Blow-out fuse, slow	2 A	2 A
Blow-out fuse, gG	4 A	4 A
Circuit breaker 24V AC/DC, characteristic B/C	2 A	2 A
Conventional thermal current	3 A	3 A
Contact material	AgSnO2	AgSnO2
Times	750108	751108
Switch-on delay		
With automatic start after power on typ.	100 ms	100 ms
With automatic start after power on max.	150 ms	150 ms
Delay-on de-energisation		
With E-STOP typ.	30 ms	30 ms
With E-STOP max.	40 ms	40 ms
With power failure typ.	30 ms	30 ms
With power failure max.	40 ms	40 ms

Environmental data	750108	751108
Climatic suitability	EN 60068-2-78	EN 60068-2-78
Ambient temperature		
Temperature range	-10 - 55 °C	-10 - 55 °C
Storage temperature		
Temperature range	-40 - 85 °C	-40 - 85 °C
Climatic suitability		
Humidity	93 % r. h. at 40 °C	93 % r. h. at 40 °C
Condensation during operation	Not permitted	Not permitted
EMC	EN 60947-5-1, EN 61000-6-2, EN 61000-6-4, EN 61326-3-1	EN 60947-5-1, EN 61000-6-2, EN 61000-6-4, EN 61326-3-1
Vibration		
In accordance with the standard	EN 60068-2-6	EN 60068-2-6
Frequency	10 - 55 Hz	10 - 55 Hz
Amplitude	0,35 mm	0,35 mm
Airgap creepage		
In accordance with the standard	EN 60947-1	EN 60947-1
Overvoltage category	III / II	III / II
Pollution degree	2	2
Rated insulation voltage	250 V	250 V
Rated impulse withstand voltage	4 kV	4 kV
Protection type		
Housing	IP40	IP40
Terminals	IP20	IP20
Mounting area (e.g. control cabinet)	IP54	IP54
Mechanical data	750108	751108
Mounting position	Any	Any
Mechanical life	5,000,000 cycles	5,000,000 cycles
Material		
Bottom	PC	PC
Front	PC	PC
Top	PC	PC
Connection type	Screw terminal	Spring-loaded terminal
Mounting type	plug-in	plug-in
Conductor cross section with screw terminals		
1 core flexible	0,25 - 2,5 mm², 24 - 12 AWG	–
2 core with the same cross section, flexible with crimp connectors, no plastic sleeve	0,25 - 1 mm², 24 - 16 AWG	–
2 core with the same cross section, flexible without crimp connectors or with TWIN crimp connectors	0,2 - 1,5 mm², 24 - 16 AWG	–
Torque setting with screw terminals	0,5 Nm	–

Mechanical data	750108	751108
Conductor cross section with spring-loaded terminals: Flexible with/without crimp connector	–	0,2 - 2,5 mm ² , 24 - 12 AWG
Spring-loaded terminals: Terminal points per connection	–	2
Stripping length with spring-loaded terminals	–	9 mm
Dimensions		
Height	98 mm	100 mm
Width	12,5 mm	12,5 mm
Depth	120 mm	120 mm
Weight	105 g	105 g

Where standards are updated, the 2017-01 latest editions shall apply.

Safety characteristic data



NOTICE
 You must comply with the safety-related characteristic data in order to achieve the required safety level for your plant/machine.

Operating Mode	EN ISO 13849-1: 2015 PL	EN ISO 13849-1: 2015 Category	EN 62061 SIL CL	EN 62061 PFH _D [1/h]	IEC 61511 SIL	IEC 61511 PFD	EN ISO 13849-1: 2015 T _M [year]
Safety contacts, instantaneous	PL c	Cat. 3	SIL CL 2	2,00E-07	SIL 2	6,35E-03	20

All the units used within a safety function must be considered when calculating the safety characteristic data.



INFORMATION
 A safety function's SIL/PL values are **not** identical to the SIL/PL values of the units that are used and may be different. We recommend that you use the PAscal software tool to calculate the safety function's SIL/PL values.

Supplementary data



CAUTION!

It is essential to consider the values in the relays' service life table. The relay outputs' safety-related characteristic data is only valid if the values in the service life table are met.

The PFH value depends on the switching frequency and the load on the relay output. If the values in the service life table are not accessible, the stated PFH value can be used irrespective of the switching frequency and the load, as the PFH value already considers the relay's B10d value as well as the failure rates of the other components.

Service life table

The service life table indicates the number of cycles from which failures due to wear must be expected. The wear is mainly caused by the electrical load; the mechanical load is negligible.

Load type	Switching current	Number of cycles
DC1	3 A	200,000
DC13	1.5 A	75,000
AC1	3 A	50,000
AC15	1.5 A	50,000

Permitted operating height

The values stated in the technical details apply to the use of the device in operating heights up to max. 2000 m above sea level. When used in greater heights, constraints have to be taken into account:

- ▶ Permitted maximum operating height 5000 m
- ▶ Reduction of rated insulation voltage and rated impulse withstand voltage for applications with safe separation:

Maximum operation height	Rated insulation voltage	Overvoltage category	Max. rated impulse withstand voltage
3000 m	150 V	II	2.5 kV
	100 V	III	2.5 kV
4000 m	150 V	II	2.5 kV
	100 V	III	2.5 kV
5000 m	100 V	II	1.5 kV
	24 V	III	0.8 kV

- ▶ Reduction of rated insulation voltage and rated impulse withstand voltage for applications with basic insulation:

Maximum operation height	Rated insulation voltage	Overvoltage category	Max. rated impulse withstand voltage
3000 m	250 V	II	2.5 kV
	150 V	III	2.5 kV
4000 m	250 V	II	2.5 kV
	150 V	III	2.5 kV
5000 m	150 V	II	1.5 kV
	100 V	III	1.5 kV

- ▶ From an operating height of 2000 m the max. permitted ambient temperature is reduced by 0.5 °C/100 m

Operating height	Permitted ambient temperature
3000 m	50 °C
4000 m	45 °C
5000 m	40 °C

Remove plug-in terminals

Procedure: Insert the screwdriver into the housing recess behind the terminal and lever the terminal out.

Do **not** remove the terminals by pulling the cables!

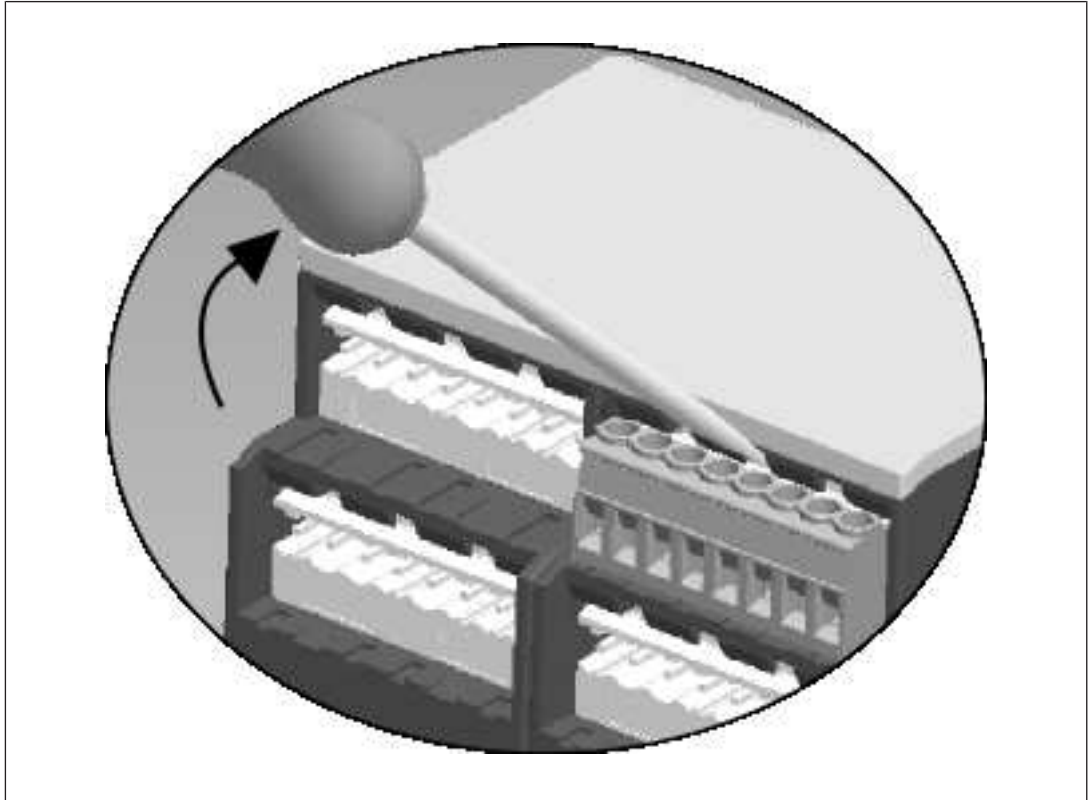

Order reference

Product type	Features	Connection type	Order No.
PNOZ s8	24 VDC	Screw terminals	750 108
PNOZ s8 C	24 VDC	Spring-loaded terminals	751 108

EC declaration of conformity

This product/these products meet the requirements of the directive 2006/42/EC for machinery of the European Parliament and of the Council. The complete EC Declaration of Conformity is available on the Internet at www.pilz.com/downloads.

Representative: Norbert Fröhlich, Pilz GmbH & Co. KG, Felix-Wankel-Str. 2, 73760 Ostfildern, Germany

► Support

Technical support is available from Pilz round the clock.

Americas

Brazil

+55 11 97569-2804

Canada

+1 888-315-PILZ (315-7459)

Mexico

+52 55 5572 1300

USA (toll-free)

+1 877-PILZUSA (745-9872)

Asia

China

+86 21 60880878-216

Japan

+81 45 471-2281

South Korea

+82 31 450 0680

Australia

+61 3 95600621

Europe

Austria

+43 1 7986263-0

Belgium, Luxembourg

+32 9 3217575

France

+33 3 88104000

Germany

+49 711 3409-444

Ireland

+353 21 4804983

Italy, Malta

+39 0362 1826711

Scandinavia

+45 74436332

Spain

+34 938497433

Switzerland

+41 62 88979-30

The Netherlands

+31 347 320477

Turkey

+90 216 5775552

United Kingdom

+44 1536 462203

You can reach our international hotline on:

+49 711 3409-444

support@pilz.com

Pilz develops environmentally-friendly products using ecological materials and energy-saving technologies. Offices and production facilities are ecologically designed, environmentally-aware and energy-saving. So Pilz offers sustainability, plus the security of using energy-efficient products and environmentally-friendly solutions.

Energy
saving by Pilz



CMSE®, InduraNET p®, PAS4000®, PASscal®, PASconfig®, Pilz®, PIT®, PLID®, PMCPirotego®, PMCiendo®, PMD®, PMi®, PNOZ®, Pirmo®, PSEN®, PSENi®, PSS®, PViS®, SafetyBUS SafetyEYE®, SafetyNET p®, THE SPIRIT OF SAFETY® are registered and protected trademarks of Pilz GmbH & Co. KG in some countries. We would point out that product features mentioned in the details stated in this document, depending on the status at the time of publication and the scope of the equipment. We accept no responsibility for the validity, accuracy and entirety of the text and graphics presented in this information. Please contact our Technical Support if you have any questions.

21400-EN-10, 2017-06 Printed in Germany
© Pilz GmbH & Co. KG, 2015

Pilz GmbH & Co. KG
Felix-Wankel-Straße 2
73760 Ostfildern, Germany
Tel.: +49 711 3409-0
Fax: +49 711 3409-133
info@pilz.com
www.pilz.com

PILZ
THE SPIRIT OF SAFETY