

Type 8035 can be combined with...

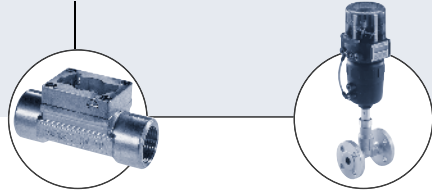

**Fitting Type S030**

Stainless steel/brass

**Type 2712**

Globe control valve

- 5/16" to 2" (8 to 50 mm) orifice
- Flow measurement for liquids with low solid content
- Flow indication including 2 totalizers
- Available as compact version, or for control cabinet or remote mounting
- Batching unit with 3 different dosing modes (local, binary input, time proportional)
- Approvals: 

The complete Type 8035 INLINE transmitter consists of a compact body with an integrated paddle wheel (Type S030) and an electronics module (Type SE35). The paddle wheel is set into motion by the medium flow, and generates a flow-proportional frequency signal in the transducer, which is converted into various output signals in the transmitter electronics. The transmitter provides standard or pulsed

output signals that are proportional to the flow. In addition, the transmitter is fitted with a flow indicator, 2 totalisers (main and daily count) for measuring quantities and 2 adjustable switching relays. In a variant with 2 limit value relays, the transmitter becomes a flow switch. A battery-driven unit can be used for the effective display of the totalisers and the flow. The batching unit is equipped with 2 totalisers, 2 relays and 3 dosing

modes (via keyboard, via the binary inputs, pulse-width modulated via a PLC). The convenient, multi-language operating menu contains special functions such as Teach-in for the K-factor correction, flow simulation for the "dry process test" and so on. The Type 8035 is suitable for use with neutral and aggressive liquids.

Technical data	
<b>Measurement range</b>	From 0.26 gpm (1 l/min)
<b>Flow velocity</b>	1.0 to 32.8 ft/s (0.3 to 10 m/s)
<b>Errors in measurement [%]</b> (see chart)	≤ ±(0.5% o.F.S. +2.5% o.R.) for water 68°F (+20°C) and o.F.S. = 32.8 ft/s (10 m/s)
<b>Repeatability</b>	0.4% o.R.
<b>Protection class</b>	IP 65 with cable plug
<b>Relative humidity (RH)</b>	≤ 80%, non condensated
<b>Media temperature</b> with PVC/PP with PVDF, Ms, VA	(see also Pressure-temperature chart) 32°F to 122/176°F (0°C to +50/+80 °C) 32°F to 212°F (0°C to +100°C)
<b>Ambient temperature</b>	32°F to 140°F (0°C to +60°C)
<b>Storage temperature</b>	32°F to 140°F (0°C to +60°C)
<b>Max. fluid pressure</b> with plastic fitting with metal fitting	140 PSI (PN 10) (see also Pressure-temp chart) 230 PSI (PN 16)
<b>Wetted materials</b> Plastic body Metal body Paddle wheel Axle and bearings O-ring	PVC, PP, PVDF Stainless steel 316L/1.4404 or brass PVDF Ceramic FKM (EPDM optional)
<b>Other materials</b> Electronics housing Front plate foil	PC Polyester
<b>Orifice</b>	5/16" - 2" (DN 8 - DN 50)

Unit variants	
<b>Flow transmitter</b>	
<b>Operating voltage</b>	12 to 30 V DC, 230 V AC
<b>Output signal</b>	4 - 20 mA
<b>Load</b>	Max. 900 Ω at 30 V, max. 500 Ω at 24 V Max. 100 Ω at 15 V, max. 800 Ω at 230 V AC
<b>Pulse output</b>	Open-Collector NPN or PNP 0 to 30 V, 100 mA protected
<b>Impulse length</b>	100 ms
<b>Reed relay pulse output</b>	Max. 34 V, 0,2 A, switching frequency max. 5 Hz
<b>Relay output</b>	2 N/O contacts, 3 A, 230 V, effective load
<b>Flow switch</b>	
<b>Operating voltage</b>	12 to 30 V DC, 230 V AC
<b>Relay output</b>	2 N/O contacts, adjustable, voltage-free
<b>Batching unit with 3 dosing modes</b>	
<b>Operating voltage</b>	12 to 30 V DC, 230 V AC
<b>4 digital inputs</b>	5 to 30 V DC
<b>Functions</b>	Batching quantity choice, start-stop dosing
<b>Digital output</b>	Open-Collector NPN or PNP, 0 up to 30 V, 100 mA protected, for status display and alarm messages
<b>Relay output</b>	2 N/O contacts, voltage-free, 3 A, 230 V, effective load
<b>Battery model</b>	
<b>Operating voltage</b>	9 V DC, battery

**Measuring principle and installation**

The sensor part consists of a transducer and an open cell paddle-wheel. When liquid flows through the pipe, the paddle-wheel is set in rotation producing a measuring signal in the transducer. The frequency and amplitude are proportional to the flow.

The minimum straight upstream (10 x DN) and downstream (3 x DN) must be observed. According to pipe's design, necessary distances can be bigger or use a flow conditioner to obtain the best accuracy. For more information, please refer to EN ISO 5167-1.

The fitting can be installed in either horizontal or vertical pipes. Pressure and temperature ratings must be respected according to the selected fitting material (see pressure/temperature chart). The suitable fitting size is selected using the diagrams of selection.

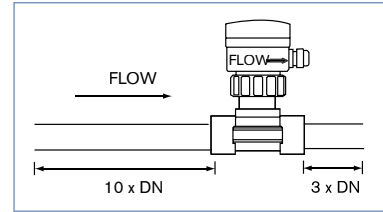

**Mounting with Bayonet connector**

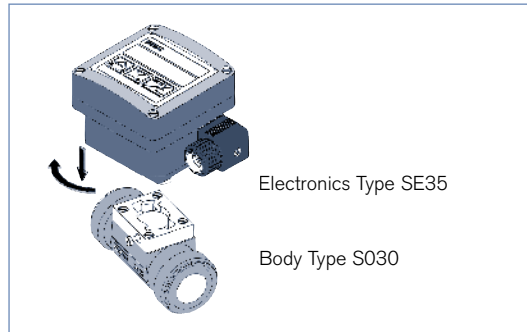

**Dimensions [mm] see ordering chart for fittings**

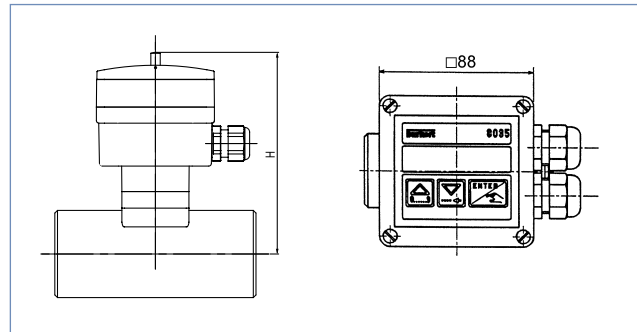

**Conception**

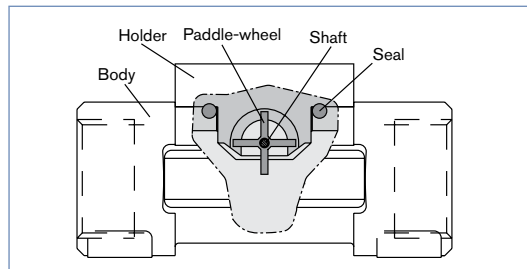

**Pressure-temperature chart for plastic fittings with INLINE sensors**

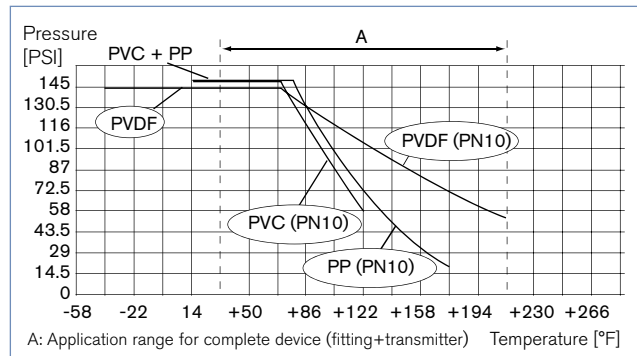

**Errors-in-measurement chart**

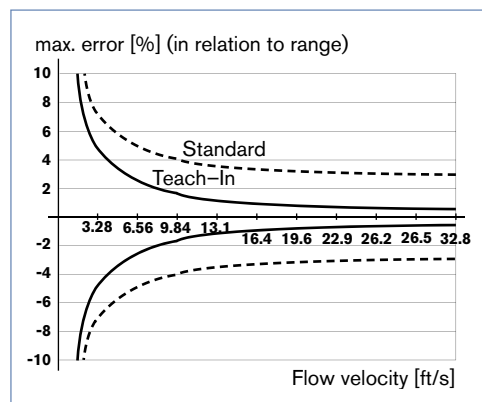

Presentation of max. errors in measurement in %  
 Standard:  $\leq \pm(0.5\% \text{ o.F.S.} + 2.5\% \text{ o.R.})$   
 Teach-In:  $\leq \pm 0.5\% \text{ o.F.S.}$   
**o.F.S.** = of Full Scale (32.8 ft/s)  
**o.R.** = of Reading

## Ordering charts

Ordering chart for Type SE35 transmitter electronics (other versions on request)

Model	Voltage/ frequency	Electrical connection	Item no.
Flow transmitter with 4 to 20 mA, pulsed output, 2 totalizers	12-30 V DC	DIN 43650 PG9 cable plug	423 915 F
Flow transmitter with 4 to 20 mA, pulsed output, 2 totalizers (UR/CSA approved)	12-30 V DC	DIN 43650 PG9 cable plug	553 432 M
Flow transmitter with 4 to 20 mA, pulsed output, 2 totalizers	12-30 V DC	1x PG 13.5 cable gland entry	423 916 G
Flow transmitter with 4 to 20 mA, pulsed output, 2 totalizers, 2 relays	12-30 V DC	2x PG 13.5 cable gland entry	423 918 J
Flow transmitter with 4 to 20 mA, pulsed output, 2 totalizers, 2 relays (UR/CSA approved)	12-30 V DC	2x PG 13.5 cable gland entry	553 433 N
Flow transmitter with 4 to 20 mA, pulsed output, 2 totalizers	115-230 V AC	2x PG 13.5 cable gland entry	423 922 E
Flow transmitter with 4 to 20 mA, pulsed output, 2 totalizers, 2 relays	115-230 V AC	2x PG 13.5 cable gland entry	423 924 G
Flow switch with 2 relays	12-30 V DC	2x PG 13.5 cable gland entry	423 917 H
Flow switch with 2 relays	115-230 V AC	2x PG 13.5 cable gland entry	423 923 F
Battery unit with 2 totalizers, 1 flow	9 V DC batteries	-	423 921 D
Batching unit with 2 totalizers, 1 flow, 2 relays	12-30 V DC	2x PG 13.5 cable gland entry	423 920 Q
Batching unit with 2 totalizers, 1 flow, 2 relays	115-230 V AC	2x PG 13.5 cable gland entry	423 926 A

**Note regarding the ordering of a complete transmitter:**

A transmitter consists of the Type S030 compact body and the Type SE35 transmitter electronics.  
Please order the respective compact body and the transmitter electronics separately!

**Attention!**

No liability will be accepted for design errors.  
Please contact our Burkert engineers as early as possible in the planning phase.

**A Compact Flow Transmitter System 8035** consists of two basic components:

- Fitting Type S030 which houses the inline rotor
- Electronic Transmitter, compact version Type SE35

**Selection Example:** A flow Transmitter System for 1" PVC pipe:

- Fitting Type S030 (true union with solvent spigot) 423 952 L
- Electronic Transmitter Type SE35 (4-20mA, pulse output, 2 relays, 12 to 30 VDC) 423 930 J

**Fittings S030 - ordering chart - BRASS, INLINE "Turn & Lock"**

Specification	Item no.							
	1/2" (DN6) <sup>2)</sup>	1/2" (DN8) <sup>2)</sup>	1/2"	3/4"	1"	1-1/4"	1-1/2"	2"
G-port connection (internal thread) <sup>1)</sup>	430 328 D	433 866 Q	423 980 M	423 981 A	423 982 B	423 983 C	423 984 D	423 985 E
NPT-port connection (internal thread)		449 182 T	423 986 F	423 987 G	423 988 R	423 989 J	423 990 P	423 991 C

1) Metric thread

2) Reduced orifice

Has to be ordered seperately

**Fittings S030 - ordering chart - PLASTIC, INLINE "Turn & Lock"**

Specification	Item no.					
	1/2"	3/4"	1"	1-1/4"	1-1/2"	2"
PVC True Union with solvent spigot (ASTM version)	423 950 W	423 951 K	423 952 L	423 953 M	423 954 N	423 955 P
PP True Union with fusion spigot (ISO version, metric pipe)	423 956 Q	423 957 R	423 958 S	423 959 T	423 960 Y	423 961 M
PVDF True Union with fusion spigot (ISO version, metric pipe)	423 968 U	423 969 V	423 970 S	423 971 P	423 972 Q	423 973 R

Has to be ordered seperately

## Fittings S030 - ordering chart - STAINLESS STEEL, INLINE "Turn &amp; Lock"

Specification	Item no.								
	1/2" (DN6) <sup>2)</sup>	1/2" (DN8) <sup>2, 3)</sup>	1/2"	3/4"	1"	1-1/4"	1-1/2"	2"	2-1/2"
G-port connection (internal thread) <sup>1)</sup>			424 004 K	424 005 L	424 006 M	424 007 N	424 008 X	424 009 Y	
NPT-port connection (internal thread)	on request	449 050 M	424 010 L	424 011 H	424 012 A	424 013 B	424 014 C	424 015 D	
Flange-port connection (ANSI B16-6-1988)			424 046 L	424 047 M	424 048 W	424 049 X	424 050 U	424 051 R	
U.S. Tri-Clamp connection				443 395 S	443 396 T		443 397 U	443 398 D	443 399 E
U.S. Buttweld connection				443 369 P	443 370 L	443 371 H	443 372 A	443 373 B	443 374 C

1) Metric thread

2) Reduced orifice

3) Male external thread

Has to be ordered separately

## Ordering chart for accessories

Ordering chart for accessories	
Accessories	Item no.
1/2" NPT conduit ring for converting cable DIN plug	014132F
1/2" NPT conduit kit for converting cable gland entry	551782S

## Ordering chart panel and wall-mount versions Type 8035

**A Flow Transmitter System, Remote Mount**, consists of three basic components:

- Separate Transmitter Electronic Type 8025 in panel or wall-mount version
- Flow Sensor Electronic Type SE30
- Fitting Type S030 which houses the inline rotor

**Selection Example:**

- Sep. Electronic Transmitter Type 8025 (wall, 4-20mA, pulse output, 2 totalizers, 2 relays, 12 to 30 VDC) 418 396 S
- Fitting Type S030 (PVC, True union with solvent spigot, 1 inch) 423 952 L
- Electronic Sensor Type SE30 (hall sensor "low power") 423 914 E

Panel version			
Specifications	Power Supply	Electrical connection	Item no.
Flow transmitter with 4-20mA, pulse output, 2 totalizers	12-30 VDC	None	418 992 Q
Flow transmitter with 4-20mA, pulse output, 2 totalizers, 2 relays	12-30 VDC	None	418 994 J
Flow transmitter with 4-20mA, pulse output on relay reed, 2 totalizers	12-30 VDC	None	418 395 Z
Flow switch with 2 relays	12-30 VDC	None	425 492 A
Batch controller with 2 totalizers, 1 flow, 2 relays	12-30 VDC	None	419 536 P

Ordering chart panel and wall-mount versions Type 8035 (continued)

Wall-mount version			
Specifications	Power Supply	Electrical connection	Item no.
Flow transmitter with 4-20mA, pulse output, 2 totalizers	12-30 VDC	3x PG 9	418 397 T
Flow transmitter with 4-20mA, pulse output, 2 totalizers, 2 relays	12-30 VDC	3x PG 9	418 396 S
Flow transmitter with 4-20mA, pulse output on relay reed, 2 totalizers	12-30 VDC	3x PG 9	418 398 C
Flow switch with 2 relays	12-30 VDC	3x PG 9	425 493 B
Batch controller with 2 totalizers, 1 flow, 2 relays	12-30 VDC	3x PG 9	433 740 D
Stand alone with 2 totalizers, 1 flow	9 VDC batteries	1x PG 9	418 402 Z
Flow transmitter with 4-20mA, pulse output, 2 totalizers	115-230 VAC	3x PG 9	418 400 B
Flow transmitter with 4-20mA, pulse output, 2 totalizers, 2 relays	115-230 VAC	3x PG9	418 399 D
Flow transmitter with 4-20mA, pulse output on relay reed, 2 totalizers	115-230 VAC	3x PG 9	418 401 Y
Flow switch with 2 relays	115-230 VAC	3x PG 9	425 494 C
Batch controller with 2 totalizers, 1 flow, 2 relays	115-230 VAC	3x PG 9	433 741 S

Sensor electronic for Type SE30 remote mount version of 8025			
Specifications	Power Supply	Electrical connection	Item no.
Coil sensor (only connectable to Type 8025 wall-mount version with batteries)	None	DIN 43650 PG 9	423 912 C
Hall sensor "low power" (only compatible with Type 8025, 8021, 8023 and 8034)	from 8025	DIN 43650 PG 9	423 914 E

Selection of fitting / pipe size

Example 1:

- Specification of nominal flow: 10 m<sup>3</sup>/h
- Ideal flow velocity: 2...3m/s
- For these specifications, the diagram indicates a pipe size of 1 1/2" (DN 40)

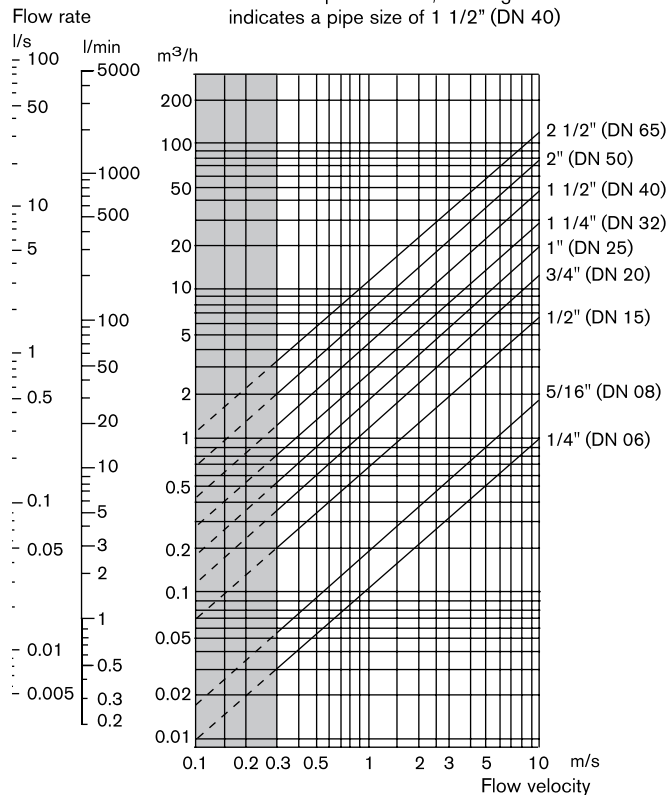

Example 2:

- Specification of nominal flow: 50 gpm
- Ideal flow velocity: 8 fps
- For these specifications, the diagram indicates a pipe size of 1 1/2" (DN 40)

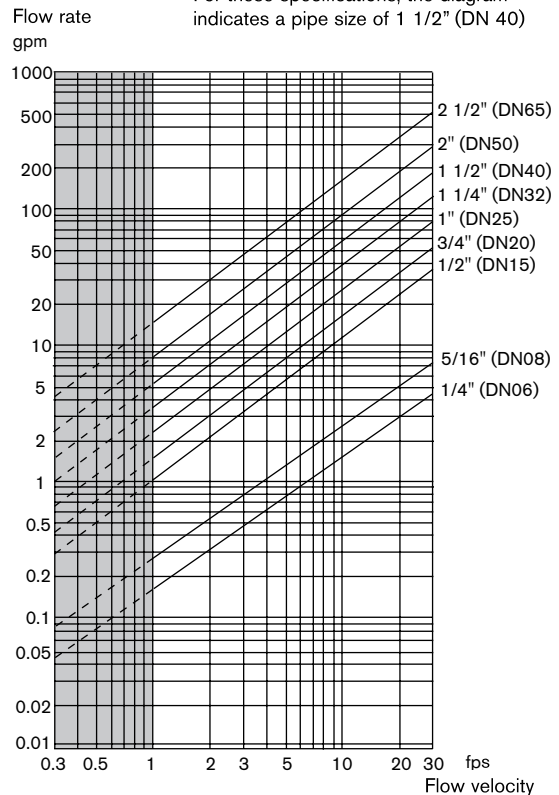

DTS 1000082467 EN Version: C Status: RL (released | freigegeben | validé) printed: 03.07.2006

**INLINE fitting dimensions [mm]**

**Internal thread**  
**Stainless steel (316L - 1,4404)**  
**or brass (CuZn39Pb2)**

**NPT**  
**G**  
**Rc**

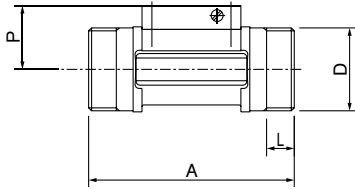

Orifice DN [mm]	P [mm]	A [mm]	D [inch]	L [mm]
1/2" (15)	34.5	85.0	NPT 1/2	17.0
			G 1/2	16.0
			Rc 1/2	15.0
3/4" (20)	32.0	95.0	NPT 3/4	18.3
			G 3/4	17.0
			Rc 3/4	16.3
1" (25)	32.2	105.0	NPT 1	18.0
			G 1	23.5
			Rc 1	18.0
1 1/4" (32)	35.8	120.0	NPT 1 1/4	21.0
			G 1 1/4	23.5
			Rc 1 1/4	21.0
1 1/2" (40)	39.6	130.0	NPT 1 1/2	20.0
			G 1 1/2	23.5
			Rc 1 1/2	19.0
2" (50)	45.7	150.0	NPT 2	24.0
			G 2	27.5
			Rc 2	24.0

**Externall thread**  
**Stainless steel (316L - 1,4404)**  
**or brass (CuZn39Pb2)**  
**or PVC (only DN6 and 8)**  
**or PVDF (only DN 8)**

**G**

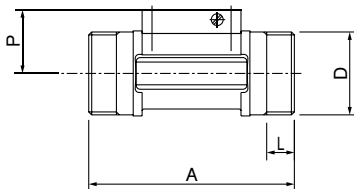

Orifice DN [mm]	P [mm]	A [mm]	D [inch]	D [mm]	L [mm]
1/4" (15)	29.5	90.0	1/4 or 1/2**	-	14.0
5/16 (8)	29.5	90.0	1/2**	M16 x 1.5	14.0
1/2" (15)	34.5	84.0	G 3/4	-	11.5
3/4" (20)	32.0	94.0	G 1	-	13.5
1" (25)	32.2	104.0	G 1 1/4	-	14.0
1 1/4" (32)	35.8	119.0	G 1 1/2	-	18.0
1 1/2" (40)	39.6	129.0	-	M 55 x 2	19.0
2" (50)	45.7	149.0	-	M 64 x 2	20.0

\*\* NPT, G or RC according fitting version

**Externall thread**  
**Stainless steel (316L - 1,4404)**

**SMS1145**

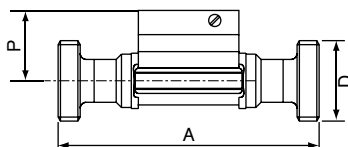

Orifice DN [mm]	P [mm]	A [mm]	D
25	32.0	130	Rd40 x 1/6"
40	35.8	164	Rd60 x 1/6"
50	39.6	173	Rd70 x 1/6"

**INLINE fitting dimensions [mm]**

**Welding ends**  
**Stainless steel (316L - 1,4404)**

**BS 4825 / ASME BPE**  
**ISO 4200**  
**SMS 3008**  
**DIN 11850 Rg2**

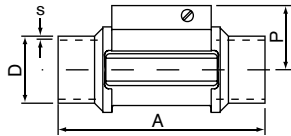

Orifice DN [mm]	P [mm]	A	Standard [mm]	D [mm]	s
5/16" (08)	29.5	90.0	ISO 4200 - SMS 3008 ASME BPE DIN 11850 Rg2	- - - 13.00	- - - 1.50
1/2" (15)	34.5	84.0	ISO 4200 21.30 SMS 3008 ASME BPE DIN 11850 Rg2	1.60 - - 19.00	- - - 1.50
3/4" (20)	32.0 34.5	94.0 84.0	ISO 4200 26.90 SMS 3008 ASME BPE DIN 11850 Rg2	1.60 20.00 19.05 23.00	1.00 1.65 1.50
1" (25)	32.2 32.0	104.0 94.0	ISO 4200 33.70 SMS 3008 BS 4825/ASME BPE DIN 11850 Rg2	2.00 25.00 25.40 29.00	1.20 1.65 1.50
1 1/4" (32)	35.8 32.2	119.0 104.0	ISO 4200 42.40 SMS 3008 BS 4825/ASME BPE DIN 11850 RG2	2.00 - 32.00 35.00	- - 1.60 1.50
1 1/2" (40)	39.6 35.8	129.0 119.0	ISO 4200 48.30 SMS 3008 BS 4825/ASME BPE DIN 11850 Rg2	2.00 38.00 38.10 41.00	1.20 1.65 1.50
2" (50)	45.7 39.6	149.0 128.0	ISO 4200 60.30 SMS 3008 BS 4820/ASME BPE DIN 11850 Rg2	2.00 51.00 50.80 53.00	1.20 1.65 1.50
2 1/2" (65)	45.7	147.0	ISO 4200 - SMS 3008 BS 4825/ASME BPE DIN 11850 Rg2	- 63.50 63.50 -	1.60 1.65 -

**INLINE fitting dimensions [mm]**

**Tri-Clamp®**  
**Stainless steel (316L - 1,4404)**  
**BS 4825 / ASME BPE\***  
**ISO (for pipe ISO 4200)**  
**SMS 3017 / ISO 2852\***  
**DIN 32676**

\*Available with internal surface finish Ra=0.8µm

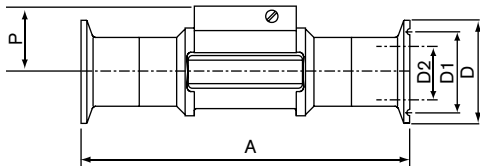

Orifice DN [mm]	P [mm]	A [mm]	Standard	D2 [mm]	D1 [mm]	D [mm]
5/16" (08)	-	-	ISO (for pipe ISO 4200)	-	-	-
			SMS 3017/ISO 2852	-	-	-
			ASME BPE	-	-	-
			DIN 32676	10.00	27.5	34.0
1/2" (15)	34.5	130.0	ISO (for pipe ISO 4200)	18.1	27.5	34.0
			SMS 3017/ISO 2852	-	-	-
			ASME BPE	-	-	-
			DIN 32676	16.00	27.5	34.0
3/4" (20)	32.0 34.5	150.0	ISO (for pipe ISO 4200)	23.7	43.5	50.5
			SMS 3017/ISO 2852	-	-	-
			ASME BPE	15.75	-	25.0
			DIN 32676	22.00	27.5	34.0
1" (25)	32.2 32.0	160.0	ISO (for pipe ISO 4200)	29.7	43.5	50.5
			SMS 3017/ISO 2852	22.6	43.5	50.5
			BS 4825/ASME BPE	22.1	43.5	50.5
			DIN 32676	26.0	43.5	50.5
1 1/4" (32)	35.8 -	180.0	ISO (for pipe ISO 4200)	38.4	43.5	50.5
			SMS 3017/ISO 2852	-	-	-
			ASME BPE	-	-	-
			DIN 32676	-	-	-
1 1/2" (40)	39.6 35.8	200.0	ISO (for pipe ISO 4200)	44.3	56.5	64.0
			SMS 3017/ISO 2852	35.6	43.5	50.5
			BS 4825/ASME BPE	34.8	43.5	50.5
			DIN 32676	38.0	43.5	50.5
2" (50)	45.7 39.6	230.0	ISO (for pipe ISO 4200)	55.1	70.5	77.5
			SMS 3017/ISO 2852	48.6	56.5	64.0
			BS 4825/ASME BPE	47.5	56.5	64.0
			DIN 32676	50.0	56.5	64.0
2 1/2" (65)	45.7	216.0	SMS 3017/ISO 2852	60.3	70.5	77.5
			BS 4825/ASME BPE	60.2	70.5	77.5
			DIN 32676	-	-	-



**INLINE fitting dimensions [mm]**

**Flange** **ANSI B16-5-1988**  
**Stainless steel (316L - 1,4404)** **DIN 2633 (ISO PN16)**  
**JIS 10K**

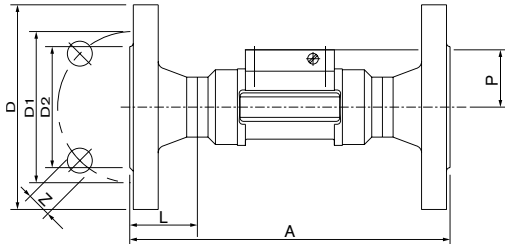

Orifice DN	P	A		NORM	L	Z	D2	D1	D				
		DIN/ ANSI [mm]	JIS [mm]										
1/2" (15)	34.5	130.0	152.0	DIN	23.5	4x14.0	45.0	65.0	95.0				
				ANSI						4x15.8	34.9	60.3	89.0
				JIS						4x15.0	51.0	70.0	95.0
3/4" (20)	32.0	150.0	178.0	DIN	28.5	4x14.0	58.0	75.0	105.0				
				ANSI						4x15.8	42.9	69.8	99.0
				JIS						4x15.0	56.0	75.0	100.0
1" (25)	32.2	160.0	216.0	DIN	28.5	4x14.0	68.0	85.0	115.0				
				ANSI						4x15.8	50.8	79.4	108.0
				JIS						4x19.0	67.0	90.0	125.0
1 1/4" (32)	35.8	180.0	229.0	DIN	31.0	4x18.0	78.0	100.0	140.0				
				ANSI						4x15.8	63.5	88.9	117.0
				JIS						4x19.0	76.0	135.0	135.0
1 1/2" (40)	39.6	200.0	241.0	DIN	36.0	4x18.0	88.0	110.0	150.0				
				ANSI						4x15.8	73.0	98.4	127.0
				JIS						4x19.0	81.0	105.0	140.0
2" (50)	45.7	230.0	267.0	DIN	41.0	4x18.0	102.0	125.0	165.0				
				ANSI						4x19.0	92.1	120.6	152.0
				JIS						4x19.0	96.0	120.0	155.0

**True union nut**  
**with solvent or fusion spigot**  
**PVC, PP, PVDF**

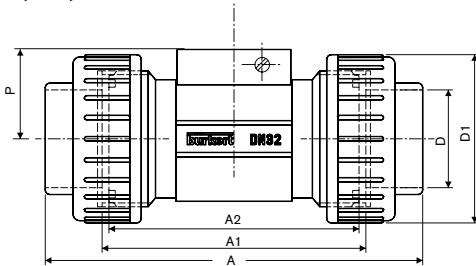

Orifice ADN [mm]	P	D1	A			D			A2	A1
			DIN	ANSI	JIS	[DIN]	[ANSI]	[JIS]		
1/4" (08)*	29.5		122	-	-	12	-	-	90	92
1/2" (15)	34.5	43	128	130.0	129	20	21.3	18.40	90	96
3/4" (20)	32.0	53	144	146.5	145	25	26.7	26.45	100	106
1" (25)	32.2	60	160	161.4	161	32	33.4	32.55	110	116
1/4" (32)	35.8	74	168	170.0	169	40	42.2	38.60	110	116
1 1/2" (40)	39.6	83	188	190.2	190	50	48.3	48.70	120	127
2" (50)	45.7	103	212	213.6	213	63	60.3	60.80	130	136

**Solvent or fusion spigot**

**PVC, PP, PVDF**

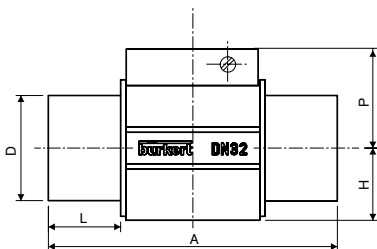

Orifice DN	D	H	A		L		P
			PVC	PP PVDF	PVC	PP PVDF	
15	20	17.5	90	85	16.5	14	34.5
20	25	17.5	100	92	20.0	16	32.0
25	32	21.5	110	95	23.0	18	32.2
32	40	27.5	110	100	27.5	20	35.8
40	50	31.5	120	106	30.0	23	39.6
50	63	39.5	130	110	37.0	27	45.7

DTS 1000082467 EN Version: C Status: RL (released | freigegeben | valide) printed: 03.07.2006

## 8035 system

<b>PVC 4-20mA and flow transmitter with flow indicator/2 totalizers and 2 flow switches 1/2"-2"</b>	
<b>PVC body with Tru-Union ends, PVDF paddle, ceramic shaft and bearings.</b> <b>Max operating is 140 PSI and 122 °F.</b> <b>FKM is standard seal material.</b> <b>1-33fps flow range capability.</b>	<b>System part number below will include fitting &amp; transmitter with two 3A SPST relays, Pulse output, 4-20mA output and 2 totalizers. Field flow simulation and field Calibration function. 24 VDC power required.</b>
1/2" Flow indicator/transmitter/2 switches/totalizer/pulse	System part # 424 618 W
3/4" Flow indicator/transmitter/2 switches/totalizer/pulse	System part # 424 619 X
1" Flow indicator/transmitter/2 switches/totalizer/pulse	System part # 424 620 U
1 1/4" Flow indicator/transmitter/2 switches/totalizer/pulse	System part # 424 621 R
1 1/2" Flow indicator/transmitter/2 switches/totalizer/pulse	System part # 424 622 J
2" Flow indicator/transmitter/2 switches/totalizer/pulse	System part # 424 623 K

<b>BRASS 4-20mA and flow transmitter with flow indicator/2 totalizers and 2 flow switches 1/2"-2"</b>	
<b>Brass body with NPT ends, PVDF paddle, ceramic shaft and bearings.</b> <b>Max operating is 230 PSI and 212 °F.</b> <b>FKM is standard seal material.</b> <b>1-33fps flow range capability.</b>	<b>System part number below will include fitting &amp; transmitter with two 3A SPST relays, pulse output, 4-20mA output and 2 totalizers. Field flow simulation and field Calibration function. 24 VDC power required.</b>
1/2" Flow indicator/transmitter/2 switches/totalizer/pulse	System part # 424 870 X
3/4" Flow indicator/transmitter/2 switches/totalizer/pulse	System part # 424 871 L
1" Flow indicator/transmitter/2 switches/totalizer/pulse	System part # 424 872 M
1 1/4" Flow indicator/transmitter/2 switches/totalizer/pulse	System part # 424 873 N
1 1/2" Flow indicator/transmitter/2 switches/totalizer/pulse	System part # 424 874 P
2" Flow indicator/transmitter/2 switches/totalizer/pulse	System part # 424 875 Q

<b>PVDF 4-20mA and flow transmitter with flow indicator/2 totalizers and 2 flow switches 20mm to 63mm</b>	
<b>PVDF fluidic module with True-Union fusion spigot, PVDF paddle, ceramic shaft and bearings.</b> <b>Max operating is 140 PSI and 212 °F.</b> <b>FKM is standard seal material.</b> <b>1-33fps flow range capability.</b>	<b>System part number below will include fitting &amp; transmitter with two 3A SPST relays, pulse output, 4-20mA output and 2 totalizers. Field flow simulation and field Calibration function. 24 VDC power required.</b>
20mm Flow indicator/transmitter/2 switches/totalizer/pulse	System part # 424 762 W
25mm Flow indicator/transmitter/2 switches/totalizer/pulse	System part # 424 763 X
32mm Flow indicator/transmitter/2 switches/totalizer/pulse	System part # 424 764 Y
40mm Flow indicator/transmitter/2 switches/totalizer/pulse	System part # 424 765 Z
50mm Flow indicator/transmitter/2 switches/totalizer/pulse	System part # 424 766 S
63mm Flow indicator/transmitter/2 switches/totalizer/pulse	System part # 424 767 T

<b>STAINLESS STEEL 4-20mA and flow transmitter with flow indicator/2 totalizers and 2 flow switches 1/2"-2"</b>	
<b>STAINLESS STEEL fluidic module with NPT ends, PVDF paddle, ceramic shaft and bearings.</b> <b>Max operating is 230 PSI and 212 °F.</b> <b>FKM is standard seal material.</b> <b>1-33fps flow range capability.</b>	<b>System part number below will include fitting &amp; transmitter with two 3A SPST relays, pulse output, 4-20mA output and 2 totalizers. Field flow simulation and field Calibration function. 24 VDC power required.</b>
1/2" Flow indicator/transmitter/2 switches/totalizer/pulse	System part # 424 978 X
3/4" Flow indicator/transmitter/2 switches/totalizer/pulse	System part # 424 979 Y
1" Flow indicator/transmitter/2 switches/totalizer/pulse	System part # 424 980 N
1 1/4" Flow indicator/transmitter/2 switches/totalizer/pulse	System part # 424 981 B
1 1/2" Flow indicator/transmitter/2 switches/totalizer/pulse	System part # 424 982 C
2" Flow indicator/transmitter/2 switches/totalizer/pulse	System part # 424 983 D