

15 and 16 Series BSP and hose fittings

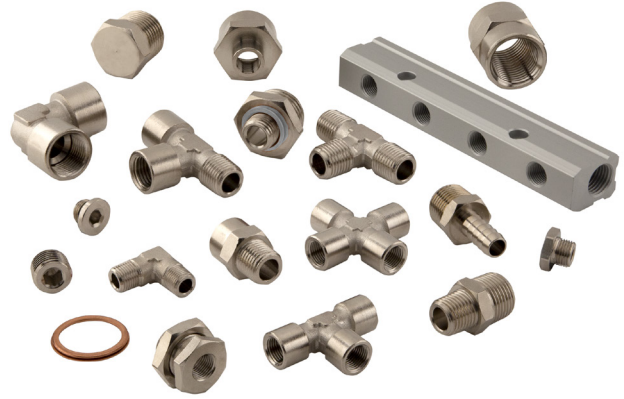

- > **Port size:**
M5, 1/8" ... 1"
- > **Extensive range of shapes and sizes including manifolds**
- > **High temperature and pressure aluminium sealing washers supplied with ISO G threads**



Technical features

Medium:

Compressed air and fluid compatible with sealing materials

Thread forms:

Tapered in conformity with ISO 7:1, BS 21, DIN 2999.
Parallel in conformity with ISO 228 Class A.
Metric in conformity with ISO R/262.

Operating pressure:

Generally limited by tubing specification except where polyamide sealing washers are used (banjo bolts and M5 units). In these cases pressure is limited to 18 bar (261 psi).
Flow regulating banjos are limited to 1 ... 10 bar (1 ... 145 psi) operating range. Suitable for vacuum applications.

Ambient/Media temperature:

Generally limited by tubing specification except where polyamide sealing washers are used (banjo bolts, & M5 units). In these cases temperature is limited to -20 ... +70°C (-4 ... 158°F)













Materials:

Body of the fittings are made from Brass type; OT UNI EN 12164/5 CW 614/7N and undergo to a nickel-plating process. Other materials will be specified with the fitting details. All ISO G male threads supplied with flat soft alloy washer unless stated otherwise.

Straight adaptors, connectors and plugs

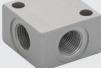
<p>ISO G - Reducing connector 16023</p>  <p>Page 3</p>	<p>ISO G - Expanding connector 16023</p>  <p>Page 3</p>	<p>ISO G - ISO R Expanding connector 15023</p>  <p>Page 3</p>	<p>ISO G - ISO R Reducing connector 15023</p>  <p>Page 3</p>	<p>NPT - ISO R Adaptor 15423</p>  <p>Page 3</p>	<p>ISO G - NPT Adaptor 17223</p>  <p>Page 3</p>	<p>Metric and ISO G - Bulkhead connector 16029</p>  <p>Page 4</p>	
<p>ISO G - Sleeve adaptor 16022</p>  <p>Page 4</p>	<p>Metric - ISO G - Nipple adaptor 16020</p>  <p>Page 4</p>	<p>ISO R - Nipple adaptor 15020</p>  <p>Page 4</p>	<p>ISO R - NPT - Nipple adaptor 15420</p>  <p>Page 4</p>				
<p>ISO R - Flat union 15033</p>  <p>Page 5</p>	<p>ISO R - Conical union 1503D</p>  <p>Page 5</p>	<p>ISO R - Hose adaptor 29117</p>  <p>Page 5</p>	<p>ISO G - Hose adaptor 29217</p>  <p>Page 5</p>				
<p>ISO G - Plug with flange - hex 16206</p>  <p>Page 6</p>	<p>ISO G - Plug with flange - spanner 16005</p>  <p>Page 6</p>	<p>ISO G - Plug 16213</p>  <p>Page 6</p>	<p>ISO R - Plug 1500</p>  <p>Page 6</p>	<p>ISO R - Plug 15113</p>  <p>Page 6</p>	<p>ISO R - Plug Brass (unplated) 25013</p>  <p>Page 6</p>		

Elbow adaptors and T-connectors

<p>ISO G - Elbow connector 16042</p>  <p>Page 7</p>	<p>ISO G - ISO R - Elbow connector 15043</p>  <p>Page 7</p>	<p>ISO R - Elbow connector 15040</p>  <p>Page 7</p>	<p>ISO G - Tee connector 16062</p>  <p>Page 8</p>	<p>ISO R - Tee connector 15060</p>  <p>Page 8</p>	<p>ISO G - ISO R Tee connector 15069</p>  <p>Page 8</p>	<p>ISO G - ISO R Tee connector 15072</p>  <p>Page 8</p>
<p>ISO G - Cross 16092</p>  <p>Page 8</p>	<p>ISO G - Cross block 16094</p>  <p>Page 8</p>	<p>ISO G - Manifold - singlesided - Brass 34050</p>  <p>Page 9</p>	<p>ISO G - Manifold - single sided - Aluminium 162B4 and 162B6</p>  <p>Page 9</p>	<p>ISO G - Manifold - double sided - Aluminium 162C4 and 162C6</p>  <p>Page 9</p>		

Elbow banjos

<p>ISO G - Banjo elbow assembly - regulating out 16K51</p>  <p>Page 10</p>	<p>ISO G - Banjo elbow assembly - non-regulating 16A51</p>  <p>Page 10</p>	<p>ISO G - Banjo elbow body 160511</p>  <p>Page 10</p>	<p>ISO G - Regulating bolt 20K00, 20L00 and 20M00</p>  <p>Page 10</p>	<p>ISO G - Non-regulating bolt 20A00 and 20B00</p>  <p>Page 10</p>
--	---	---	--	---

Seals

<p>Copper seal 48021301 ... 08</p>  <p>Page 11</p>	<p>Banjo bolt head sealing washer 48030801 ... 04</p>  <p>Page 11</p>	<p>Banjo bolt thread sealing washer 48030001 ... 04</p>  <p>Page 11</p>
--	--	--

Accessories

<p>PTFE sealing tape DB-R-12</p>  <p>Page 11</p>
--

ISO G - Reducing connector 16023

Nickel plated brass, aluminium seals

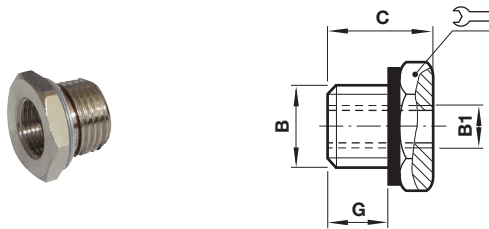

B	B1	C	G		Model
G1/8	M5	10,5	6	14	160231805
G1/4	G1/8	13	8	17	160232818
G3/8	G1/8	14	9	19	160233818
G3/8	G1/4	14	9	19	160233828
G1/2	G1/8	15,5	10	24	160234818
G1/2	G1/4	15,5	10	24	160234828
G1/2	G3/8	15,5	10	24	160234838
G3/4	G1/4	17,5	12	30	160236828
G3/4	G3/8	17,5	12	30	160236838
G3/4	G1/2	17,5	12	30	160236848

ISO G - Expanding connector 16023

Nickel plated brass, aluminium seals

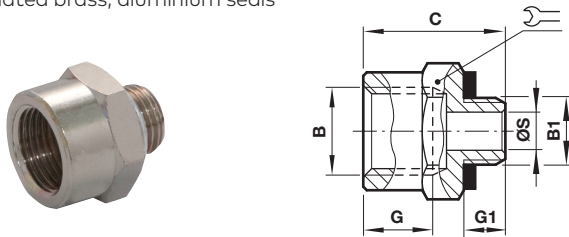

B	B1	C	G	G1	Ø S		Model
G1/8	M5	14,5	8,5	4	2,5	14	160230518
G1/4	G1/8	20,5	12	6	5,5	17	160231828
G3/8	G1/8	21,5	10,5	6	5,5	22	160231838
G3/8	G1/4	23,5	13	8	8	22	160232838
G1/2	G1/4	26,5	16	8	8	26	160232848
G1/2	G3/8	36,5	16	9	11	26	160233848
G3/4	G1/2	31	16,5	10	15	32	160234868

ISO G - ISO R - Expanding connector 15023

Nickel plated brass

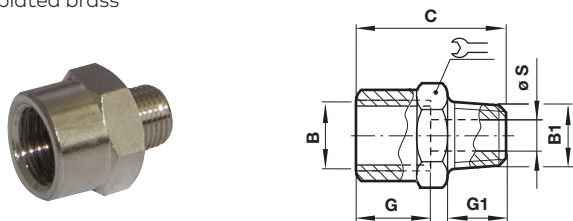

B	B1	C	G	G1	Ø S		Model
G1/4	R1/8	22	12,5	7,5	5,5	17	150231828
G3/8	R1/8	22,5	7,5	10,5	5	22	150231838
G3/8	R1/4	27	13	11	8	22	150232838
G1/2	R1/4	30	16	11	8	26	150232848
G1/2	R3/8	30,5	16	11	11	26	150233848
G3/4	R3/8	38,5	12,5	16,5	11	32	150233868
G3/4	R1/2	35	16,5	14	15	32	150234868
G1	R3/4	45	19	19	18	41	150236888

ISO G - ISO R - Reducing connector 15023

Nickel plated brass

Dimensions in mm
Projection/First angle

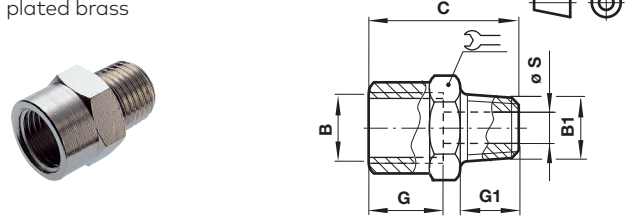

B	B1	C	G	G1	Ø S		Model
G1/8	R1/8	20	10	7,5	5,5	14	150231818
G1/8	R1/4	16	12	11	6	14	150232818
G1/4	R1/4	26	12	11	8	17	150232828
G1/8	R3/8	16,5	12	11,5	6	17	150233818
G1/4	R3/8	16,5	11,5	13	8,5	17	150233828
G3/8	R3/8	27,5	13	11,5	11	22	150233838
G1/8	R1/2	19,5	12	7,5	5,5	22	150234818
G1/4	R1/2	19,5	13	14	9,5	22	150234828
G3/8	R1/2	19,5	13	14	14	22	150234838
G1/2	R1/2	33	16	14	15	26	150234848
G1/4	R3/4	23,5	16,5	11,5	8	27	150236828
G3/8	R3/4	23,5	11,5	16,5	20	27	150236838
G1/2	R3/4	23,5	17	16,5	16	27	150236848
G1/2	R1	26,5	19	13	15	34	150238848
G3/4	R1	27,5	19	16,5	24,5	34	150238868

NPT - ISO G - Adaptor 15423

Nickel plated brass

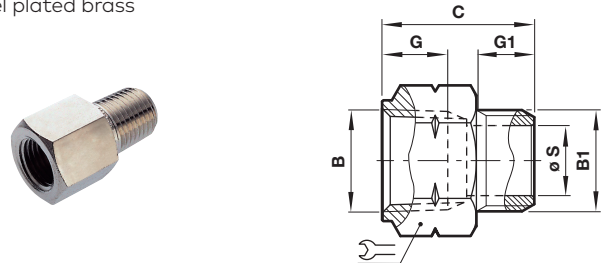

B	B1	C	G	G1	Ø S		Model
1/8 NPT	G1/8	17	9,5	6	5,5	14	154231818
1/4 NPT	G1/4	23	13,5	8	8	17	154232828
3/8 NPT	G3/8	24	13,5	9	11	22	154233838
1/2 NPT	G1/2	31,5	17,5	12	14,5	27	154234848

ISO G - NPT - Adaptor 17223

Nickel plated brass

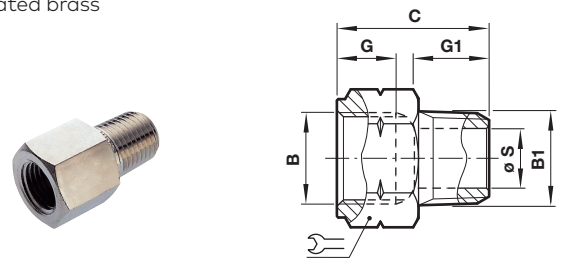



B	B1	C	G	G1	Ø S		Model
G1/4	1/4 NPT	27	12	13	8	17	172232828
G3/8	3/8 NPT	28	13	13	11	22	172233838

Metric and ISO G - Bulkhead connector 16029

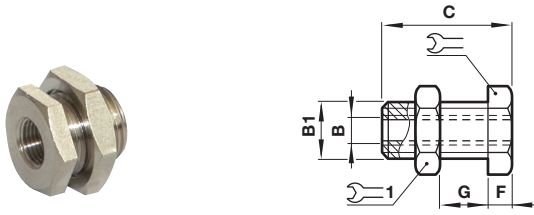
Nickel plated brass



B	B1	C	F	G max.			Model
M5	M10x1,0	14	3,5	7	14	14	160290005
G1/8	M16x1,5	18	4	10	19	22	160290018
G1/4	M20x1,5	25	4	16	24	27	160290028
G3/8	M26x1,5	26	5	15	30	32	160290038
G1/2	M28x1,5	33	6	21	32	36	160290048
G3/4	M33x1,5	36,5	6	22,5	41	41	160290068
G1	M42x1,5	41,5	8	24,5	46	50	160290088
G1 1/4	M48x1,5	50	8	29,5	55	55	1602900A8

Metric - ISO G - Nipple adaptor 16020

Nickel plated brass, aluminium seals

Dimensions in mm
Projection/First angle

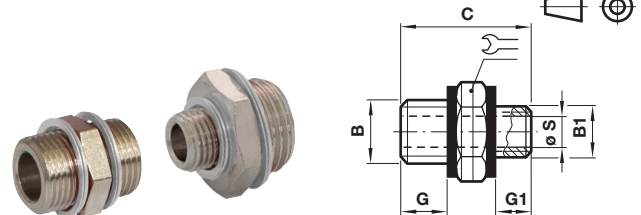

B	B1	C	G	G1	Ø S	Ø S1		Model
M5	M5	11,5	4	4	2,5	2,5	8	160200505
G1/8	M5	14,5	6	4	5,5	3,5	14	160201805
G1/8	G1/8	16,5	6	6	5,5	5,5	14	160201818
G1/4	G1/8	19	8	6	8	5,5	17	160202818
G1/4	G1/4	21	8	8	8	8	17	160202828
G3/8	G1/4	22	9	8	11	8	19	160203828
G3/8	G3/8	23	9	9	11	11	19	160203838
G1/2	G1/4	23,5	10	8	15	8	24	160204828
G1/2	G3/8	24,5	10	9	15	11	24	160204838
G1/2	G1/2	25,5	10	10	15	15	24	160204848
G3/4	G1/2	27,5	12	10	20	15	30	160206848
G3/4	G3/4	29,5	12	12	20	30	30	160206868
G1	G1	32	12	12	24	40	40	160208888

ISO G - Sleeve adaptor 16022

Nickel plated brass

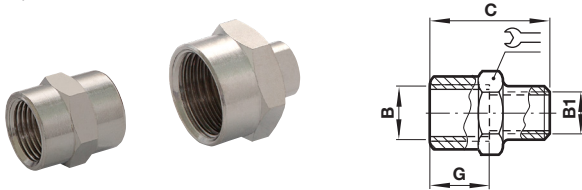

B	B1	C	G		Model
M5	M5	11	11	8	160220505
G1/8	M5	13	7,5	14	160221805
G1/8	G1/8	15	15	14	160221818
G1/4	G1/8	19	11	17	160222818
G1/4	G1/4	22	22	17	160222828
G3/8	G1/8	20	11,5	22	160223818
G3/8	G1/4	23	11,5	22	160223828
G3/8	G3/8	24	24	22	160223838
G1/2	G1/8	24	14	24	160224818
G1/2	G1/4	25	14	24	160224828
G1/2	G3/8	27,5	16	24	160224838
G1/2	G1/2	30	30	26	160224848
G3/4	G1/2	30	16,5	30	160226848
G3/4	G3/4	32	31	32	160226868
G1	G3/4	41	20	40	160228868

ISO R - Nipple adaptor 15020

Nickel plated brass

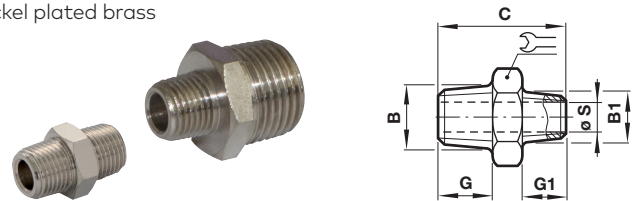

B	B1	C	G	G1	Ø S	Ø S1		Model
R1/8	R1/8	19,5	7,5	7,5	5,5	5,5	12	150201818
R1/4	R1/8	23,5	11	7,5	8	5,5	14	150202818
R1/4	R1/4	27	11	11	8	8	14	150202828
R3/8	R1/8	24	11,5	7,5	11	5,5	17	150203818
R3/8	R1/4	27,5	11,5	11	11	8	17	150203828
R3/8	R3/8	28	11,5	11,5	11	11	17	150203838
R1/2	R1/8	27	14	7,5	15	5,5	22	150204818
R1/2	R1/4	30,5	14	11	15	8	22	150204828
R1/2	R3/8	31	14	11,5	15	11	22	150204838
R1/2	R1/2	33,5	14	14	15	15	22	150204848
R3/4	R1/2	37,5	16,5	14	19	15	27	150206848
R3/4	R3/4	40	16,5	16,5	19	19	27	150206868
R1	R3/4	44	19	16,5	24	19	34	150208868
R1	R1	46,5	19	19	24	24	34	150208888

NPT - ISO R - Nipple adaptor 15420

Nickel plated brass

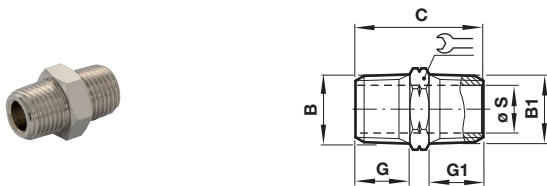

B	B1	C	G	G1	Ø S		Model
1/8 NPT	R1/8	21,5	8,5	8,5	5,5	12	154201818
1/4 NPT	R1/4	31	13	13	8	14	154202828
3/8 NPT	R3/8	31	13	13	11	19	154203838
1/2 NPT	R1/2	40	17	17	16,5	22	154204848

ISO R - Flat union 15033

Nickel plated brass, O-ring NBR
 Temperature: -20 ... +80°C
 Operating pressure: -1 ... +15 bar

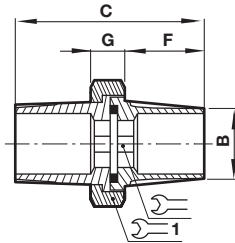
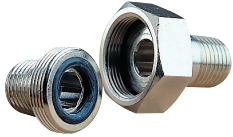

B	C	F	G	↺	↺ 1	Model
R1/8	33,5	10	8,5	5	15	150331818
R1/4	42	13	10,5	8	24	150332828
R3/8	43	13	11	10	27	150333838
R1/2	52	17,5	11,5	14	30	150334848
R3/4	56,5	19	12,5	17	38	150336868
R1	68	23	16	19	46	150338888

ISO R - Conical union 1503D

Brass, O-ring NBR
 Temperature: -20 ... +80°C
 Operating pressure: -1 ... +15 bar

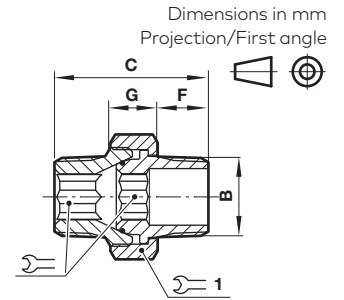

B	C	F	G	↺	↺ 1	Model
R1/8	27	9	8,5	5	15	1503D1818
R1/4	33,5	11,5	9,5	6	19	1503D2828
R3/8	36,5	13	10	8	22	1503D3838
R1/2	45	16	12	12	27	1503D4848
R3/4	54	18	17	14	36	1503D6868
R1	65	21,5	20	19	46	1503D8888

ISO R - Hose adaptor 29117

Nickel plated brass

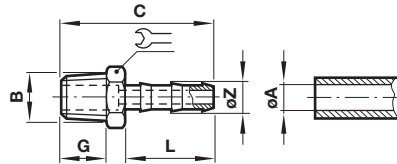

Ø A	B	C	G	L	↺	Ø Z	Model
4	R1/8	32	7,5	19,5	12	6	291170418
4	R1/4	35,5	11	19,5	14	6	291170428
6	R1/8	32	7,5	19,5	12	8	291170618
6	R1/4	35,5	11	19,5	14	8	291170628
6	R3/8	36	11,5	19,5	17	8	291170638
7	R1/8	32	7,5	19,5	14	9	291170718
7	R1/4	35	11	19,5	17	9	291170728
7	R3/8	36	11,5	19,5	17	9	291170738
8	R1/8	32	7,5	19,5	12	10	291170818
8	R1/4	35,5	11	19,5	14	10	291170828
8	R3/8	36	11,5	19,5	17	10	291170838
8	R1/2	39	14	19,5	22	10	291170848
9	R1/8	32	7,5	19,5	12	11	291170918
9	R1/4	35,5	11	19,5	14	11	291170928
9	R3/8	36	11,5	19,5	17	11	291170938
9	R1/2	39	14	19,5	17	11	291170948
10	R1/4	35,5	11	19,5	14	12	291171028
10	R3/8	36	11,5	19,5	17	12	291171038
10	R1/2	39	14	19,5	22	12	291171048
12	R3/8	36	11,5	19,5	17	14	291171238
12	R1/2	39	14	19,5	22	14	291171248
13	R1/4	35,5	11	19,5	22	15	291171328
13	R3/8	36	11,5	19,5	17	15	291171338
13	R1/2	39	14	19,5	22	15	291171348
13	R3/4	43,5	14,5	19,5	27	15	291171368
16	R3/8	36	11,5	19,5	19	18	291171638
16	R1/2	39	14	19,5	22	18	291171648
16	R3/4	43,5	16,5	19,5	27	18	291171668
19	R3/8	47,5	11,5	30	22	21	291171938
19	R1/2	49,5	14	30	22	21	291171948
19	R3/4	54	16,5	30	27	21	291171968
25	R3/4	52,5	14,5	30	28	27	291172568
25	R1	53,5	16	30	34	27	291172588
32	R1	55	16	30	36	34	291173288

Metric and ISO G - Hose adaptor 29217

Nickel plated brass, aluminium seals

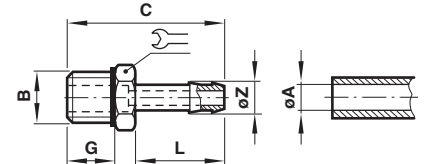

Ø A	B	C	G	L	↺	Ø Z	Model
3	M5	15,5	4	7,5	8	3,5	292170305
4	G1/8	30	6	20	14	6,5	292170418
4	G1/4	33	8	20	17	6,5	292170428
5	G1/8	30	6	20	14	7,5	292170518
6	G1/8	30	6	20	14	8,5	292170618
6	G1/4	33	8	20	17	8,5	292170628
9	G1/8	30	6	20	14	11,5	292170918
9	G1/4	33	8	20	17	11,5	292170928
9	G3/8	34	9	20	19	11,5	292170938
9	G1/2	35,5	10	20	24	11,5	292170948
10	G1/4	33	8	20	17	12,5	292171028
10	G3/8	34	9	20	19	12,5	292171038
10	G1/2	37,5	10	22	24	12,5	292171048
13	G1/4	33	8	20	17	15,5	292171328
13	G3/8	34	9	20	19	15,5	292171338
13	G1/2	37,5	10	22	24	15,5	292171348
13	G3/4	39,5	12	22	30	15,5	292171368
19	G3/4	41,5	12	24	30	21,5	292171968

ISO G - Plug with flange - spanner 16005

Nickel plated brass, aluminium seals

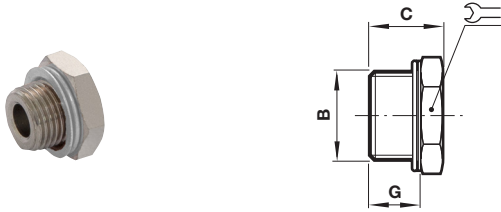



B	C	G		Model
M5	8	4,5	8	160050005
G1/8	10	6,5	14	160050018
G1/4	13	9	17	160050028
G3/8	13,5	9,5	19	160050038
G1/2	14,5	10	24	160050048
G3/4	16	11	30	160050068
G1	17	12	40	160050088

ISO G - Plug with flange - hex 16206

Nickel plated brass, O-ring NBR
Temperature: -20 ... +80°C
Operating pressure: -1 ... +15 bar

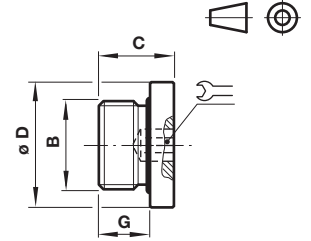
Dimensions in mm
Projection/First angle



B	C	G	ØD		Model
M5	6	4	8	2	162060005
G1/8	8,5	6	14	5	162060018
G1/4	11	8	17	6	162060028
G3/8	12,5	9	20	8	162060038
G1/2	13,5	10	25	10	162060048

ISO G - Plug 16213

Nickel plated brass

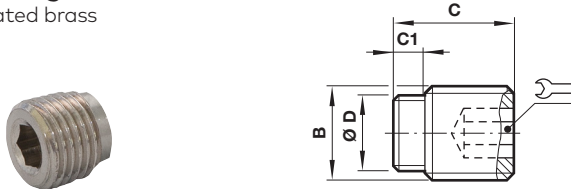

B	C	C1	ØD		Model
G1/8	8	2	8	5	162130018
G1/4	11	3	11	6	162130028
G3/8	12,5	3,5	14,5	8	162130038
G1/2	14	4	18	10	162130048
G3/4	14	3	21,5	12	162130068

ISO R - Plug 15005

Nickel plated brass

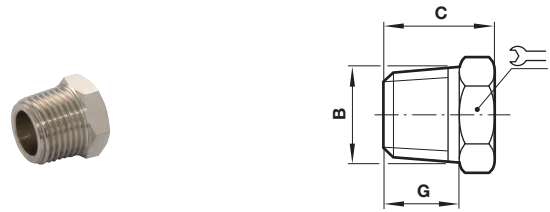

B	C	G		Model
R1/8	11	7,5	10	150050018
R1/4	15	11	14	150050028
R3/8	15,5	11,5	17	150050038
R1/2	18,5	14	22	150050048
R3/4	21,5	16,5	27	150050068
R1	25	19	34	150050088

ISO R - Plug 15113

Nickel plated brass

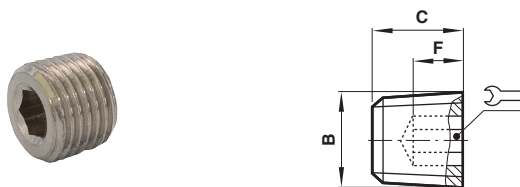

B	C	F		Model
R1/8	7,5	5	5	151130018
R1/4	10	7	6	151130028
R3/8	11	7	8	151130038
R1/2	13	8	10	151130048

ISO R - Plug 25013

Brass (unplated)

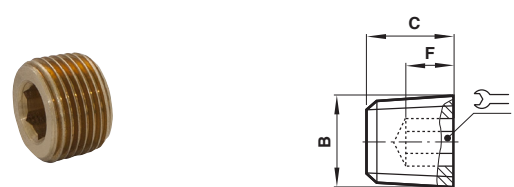

B	C	F		Model
R1/8	7,5	5	5	250130018
R1/4	10	7	6	250130028
R3/8	11	7	8	250130038
R1/2	13	8	10	250130048

ISO G - Elbow connector 16042

Nickel plated brass

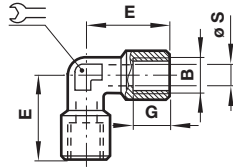

B	E	G	Ø S		Model
G1/8	21	7	5,5	11	160420018
G1/4	25,5	8,5	8	13	160420028
G3/8	28	11	11	17	160420038
G1/2	32	15	15	20	160420048
G3/4	36,5	16,5	19	27	160420068
G1	45	19	24	30	160420088

ISO G - ISO R Elbow connector 15043

Nickel plated brass

Dimensions in mm
Projection/First angle

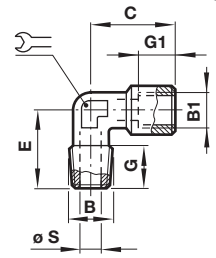

B	B1	C	E	G	G1	Ø S		Model
R1/8	G1/8	21	18	7,5	8,5	5,5	12	150430018
R1/4	G1/4	25,5	24	11	11	8	13	150430028
R3/8	G3/8	28	27	11,5	12	11	16	150430038
R1/2	G1/2	32	29,5	14	15	15	20	150430048
R3/4	G3/4	36,5	32	14,5	16,5	19	27	150430068
R1	G1	45	39	16	19	24	30	150430088

ISO R - Elbow connector 15040

Nickel plated brass

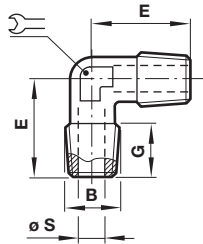

B	E	G	Ø S		Model
R1/8	18	7,5	6	11	150400018
R1/4	24	11	8	13	150400028
R3/8	27	12	11	17	150400038
R1/2	29,5	14	15	20	150400048
R3/4	32	14,5	19	27	150400068
R1	39	17	24	30	150400088

ISO R - Tee connector 15060

Nickel plated brass

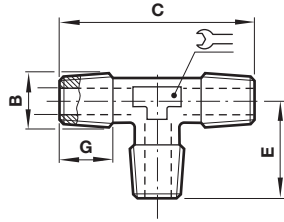

B	C	E	G	Ø S		Model
R1/8	35	17,5	8	5,5	12	150600018
R1/4	46	23	11	8	13	150600028
R3/8	51,5	25,5	11,5	11	16	150600038
R1/2	59	29,5	14	15	20	150600048
R3/4	64	32	14,5	19	27	150600068
R1	78	39	17	24	30	150600088

ISO G - Tee connector 16062

Nickel plated brass

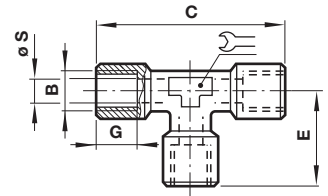
 Dimensions in mm
 Projection/First angle

B	C	E	G	Ø S		Model
G1/8	39	19,5	8,5	6	12	160620018
G1/4	49	24,5	11	8	13	160620028
G3/8	54	27	12	11	16	160620038
G1/2	64	32	15	15	20	160620048
G3/4	73	36,5	16,5	19	27	160620068
G1	90	45	19	24	30	160620088

ISO G - ISO R Tee connector 15072

Nickel plated brass

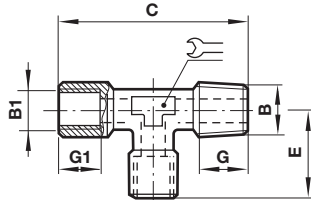

B	B1	C	E	G	G1		Model
G1/8	R1/8	37	19,5	8	8,5	12	150720018
G1/4	R1/4	47,5	24,5	11	11	13	150720028
G3/8	R3/8	52,5	27	11,5	12	16	150720038
G1/2	R1/2	61,5	32	14	15	20	150720048
G3/4	R3/4	68,5	36,5	14,5	16,5	27	150720068
G1	R1	84	45	17	19	30	150720088

ISO G - ISO R Tee connector 15069

Nickel plated brass

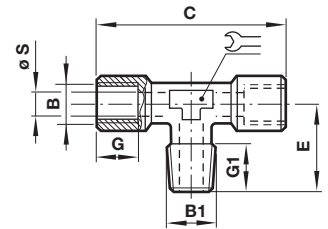

B	B1	C	E	G	G1	Ø S		Model
G1/8	R1/8	39	17,5	8,5	8	6	12	150690018
G1/4	R1/4	49	23	11	11	8	13	150690028
G3/8	R3/8	54	25,5	12	11,5	11	16	150690038
G1/2	R1/2	64	29	15	14	15	20	150690048
G3/4	R3/4	73	32	16,5	14,5	19	27	150690068
G1	R1	90	39	19	17	24	30	150690088

ISO G - Cross 16092

Nickel plated brass

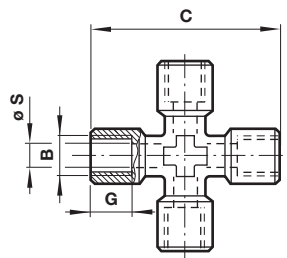

B	C	G	Ø S		Model
G1/8	39	8,5	6	11	160920018
G1/4	50	11	8	13	160920028
G3/8	56	12	11	17	160920038
G1/2	64	15	15	20	160920048

ISO G - Cross block 16094

Aluminium

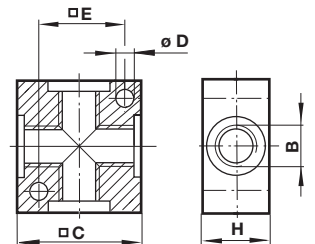

B	C	Ø D	E	H	Model
G1/8	25	4,5	17,5	16	160940018
G1/4	40	5,5	27	20	160940028
G3/8	50	5,5	35	25	160940038
G1/2	50	5,5	35	32	160940048

ISO G - Manifold - single sided 34050

Brass

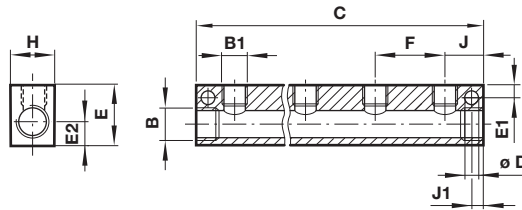
 Dimensions in mm
 Projection/First angle

Numbers of outputs: 4

B	B1	C	ØD	E	E1	E2	F	H	J	J1	Model
G1/8	G1/8	81	5,5	25	5	15	17	16	15	5	34050401
G1/4	G1/4	109	5,5	31	5	20	23	23	20	5	34050402
G3/8	G3/8	127	6,5	35	6	23	27	25,5	20	6	34050403

Numbers of outputs: 6

B	B1	C	ØD	E	E1	E2	F	H	J	J1	Model
G1/8	G1/8	115	5,5	25	5	15	17	16	15	5	34050601
G1/4	G1/4	155	5,5	31	5	20	23	23	20	5	34050602
G3/8	G3/8	181	6,5	35	6	23	27	25,5	20	6	34050603

ISO G - Manifold - single sided 162B4 and 162B6

Aluminium

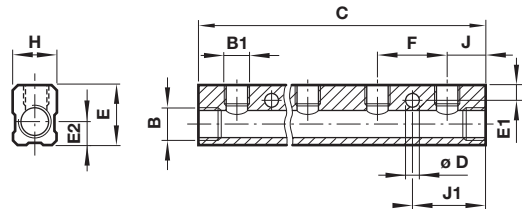
Numbers of outputs: 4

B	B1	C	ØD	E	E1	E2	F	H	J	J1	Model
G1/4	G1/8	125	4,5	24	6	9	30	18	17,5	32,5	162B42818
G3/8	G1/4	148	5,5	30	7	11	36	22	20	38	162B43828
G1/2	G3/8	170	5,5	35	7,5	13	40	26	25	45	162B44838

Numbers of outputs: 6

B	B1	C	ØD	E	E1	E2	F	H	J	J1	Model
G1/4	G1/8	185	4,5	24	6	9	30	18	17,5	32,5	162B62818
G3/8	G1/4	220	5,5	30	7	11	36	22	20	38	162B63828
G1/2	G3/8	250	5,5	35	7,5	13	40	26	25	45	162B64838

ISO G - Manifold - double sided 162C4 and 162C6

Aluminium

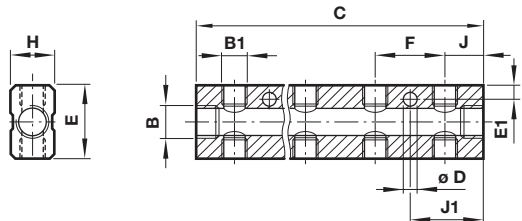
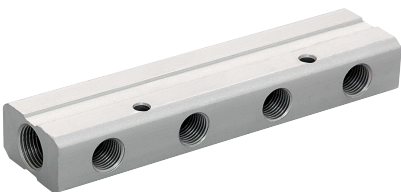
Numbers of outputs: 8

B	B1	C	ØD	E	E1	F	H	J	J1	Model
G1/4	G1/8	125	4,5	30	6	30	18	17,5	32,5	162C42818
G3/8	G1/4	148	5,5	38	7	36	22	20	38	162C43828
G1/2	G3/8	170	5,5	44	7,5	40	26	25	45	162C44838

Numbers of outputs: 12

B	B1	C	ØD	E	E1	F	H	J	J1	Model
G1/4	G1/8	185	4,5	30	6	30	18	17,5	32,5	162C62818
G3/8	G1/4	220	5,5	38	7	36	22	20	38	162C63828
G1/2	G3/8	250	5,5	44	7,5	40	26	25	45	162C64838

ISO G - Regulating out banjo elbow assembly 16K51

Regulating out, with seals
Body and regulating bolt: Nickel plated brass
Regulating screw: brass

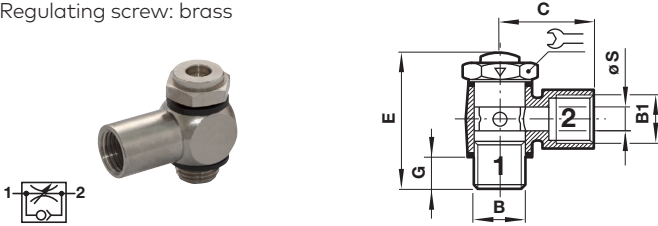

B/B1	C	E	G	Ø S	Operating pressure	⌀	Model
G1/8	21	34	7,5	6	10 bar max	14	16K511818
G1/4	28	37	8	7,6	10 bar max	17	16K512828
G3/8	31	52	12	9,6	10 bar max	22	16K513838
G1/2	47	58	14,5	9,6	10 bar max	27	16K514848

ISO G - Banjo elbow assembly 16A51

Non-regulating, with seals
Body and regulating bolt: Nickel plated brass

Dimensions in mm
Projection/First angle

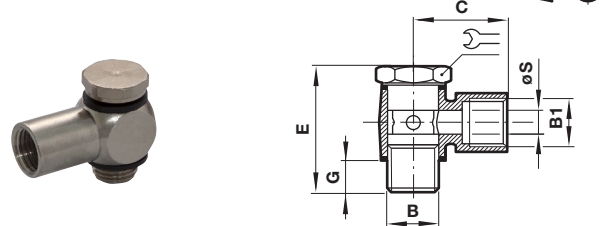

B/B1	C	E	G	Ø S	⌀	Model
G1/8	21	29	5	6	14	16A511818
G1/4	28	32	6	7,6	17	16A512828
G3/8	31	45	9,5	9,6	22	16A513838
G1/2	47	47	12	9,6	27	16A514848

ISO G - Banjo elbow body 16051

Nickel plated brass

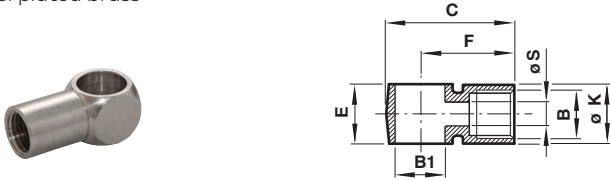

B/B1	C	E	F	Ø K	Ø S	Model
G1/8	28	14	21	13	6	160511818
G1/4	37	16	28	16	7,6	160512828
G3/8	42	20,5	31	20,5	9,6	160513838
G1/2	61	22	47	24,5	9,6	160514848

ISO G - Banjo bolt 20A00 and 20B00

Non-regulating, with seals
Nickel plated brass

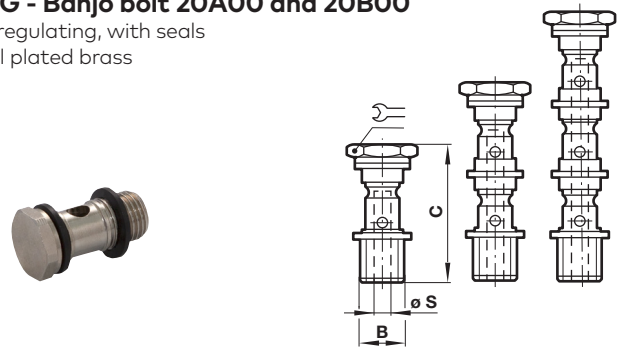

B	C	Ø S	Number banjo bodies	⌀	Model
G1/8	29	4,5	single	14	20A000018
G1/4	31,5	8	single	17	20A000028
G3/8	42,5	9,5	single	22	20A000038
G1/2	47,5	11,5	single	27	20A000048
G1/8	46,5	4,5	double	14	20B000018
G1/4	52,5	8	double	17	20B000028
G3/8	64	9,5	double	22	20B000038
G1/2	72,5	11,5	double	27	20B000048

ISO G - Regulating out banjo bolts 20K00

With seals (screwdriver adjustable), Regulating bolt: Nickel plated brass
Regulating screw: brass



B	C	Operating pressure	⌀	Model
G1/8	35	10 bar max	14	20K000018
G1/4	37,5	10 bar max	17	20K000028
G3/8	51,5	10 bar max	22	20K000038
G1/2	57	10 bar max	27	20K000048

ISO G - Regulating in banjo bolts 20L00

With seals (screwdriver adjustable), Regulating bolt: Nickel plated brass
Regulating screw: brass

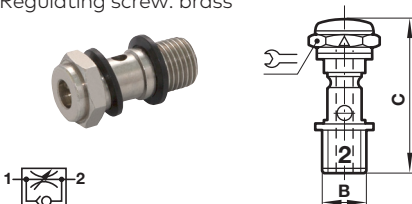

B	C	Operating pressure	⌀	Model
G1/8	34	10 bar max	14	20L000018
G1/4	36,5	10 bar max	17	20L000028
G3/8	51,5	10 bar max	22	20L000038
G1/2	57	10 bar max	27	20L000048

ISO G - Bi-directional banjo bolts 20M00

With seals (screwdriver adjustable), Regulating bolt: Nickel plated brass
Regulating screw: brass

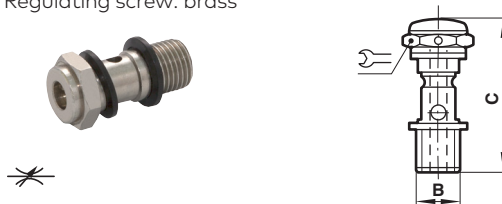

B	C	Operating pressure	⌀	Model
G1/8	35	10 bar max	14	20M000018
G1/4	37,5	10 bar max	17	20M000028
G3/8	51,5	10 bar max	22	20M000038
G1/2	57	10 bar max	27	20M000048

Copper seal
**ISO G - Copper sealing washer
48021301 ... 08**

Port size	Model
G1/8	48021301
G1/4	48021302
G3/8	48021303
G1/2	48021304
G3/4	48021306
G1	48021308

Banjo bolt sealing washers
**ISO G - Banjo bolt head sealing washer - Polyamide
48030801 ... 04**

Port size	Model
G1/8	48030801
G1/4	48030802
G3/8	48030803
G1/2	48030804

**ISO G - Banjo bolt thread sealing washer - Polyamide
48030001 ... 04**

Port size	Model
M5	48030005
G1/8	48030001
G1/4	48030002
G3/8	48030003
G1/2	48030004

 Dimensions in mm
Projection/First angle

**PTFE - sealing tape
DB-R-12**

Warning

These products are intended for use in industrial compressed air systems only. Do not use these products where pressures and temperatures can exceed those listed under »**Technical features/ data**«.

Before using these products with fluids other than those specified, for non-industrial applications, life-support systems or other applications not within published specifications, consult Norgren Ltd.

Through misuse, age, or malfunction, components used in fluid power systems can fail in various modes.

The system designer is warned to consider the failure modes of all component parts used in fluid power systems and to provide adequate safeguards to prevent personal injury or damage to equipment in the event of such failure.

System designers must provide a warning to end users in the system instructional manual if protection against a failure mode cannot be adequately provided.

System designers and end users are cautioned to review specific warnings found in instruction sheets packed and shipped with these products.