

Optional Parts

Mounting Pole

φ50 (φ40)

SZ-60L
SZ-80L

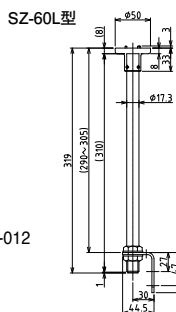

Includes SZ-012

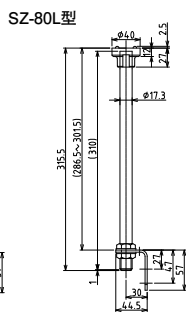

SZ-60T



Includes SZ-011

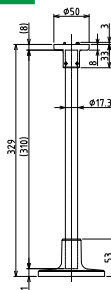

φ60

SZ-70L



Includes SZ-013

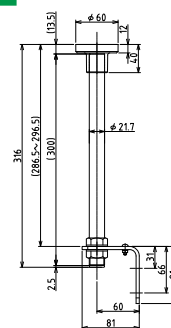

φ70

SZ-50L



Includes SZ-013

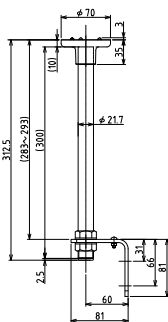

SZ-50T



Includes SZ-010

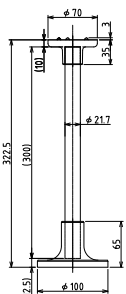

□70

SZ-40L



Includes SZ-013

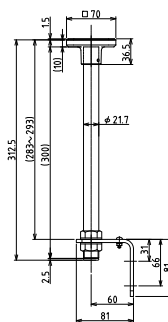

SZ-40T



Includes SZ-010

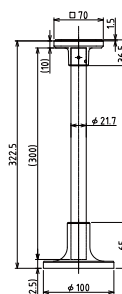

φ81

SZ-30L



Includes SZ-013

Can not use Rubber Gasket.

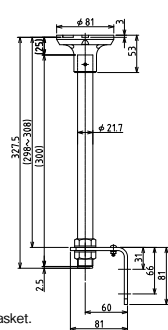

SZ-30T



Includes SZ-010

Can not use Rubber Gasket.

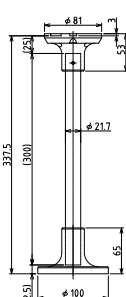

Model	Material					
	Upper bracket	Pole	L Bracket	Cord bushing	Circular	For
SZ-80L	ABS resin	Carbon steel pipe	SPHC	6/6 nylon	—	LCE-W
SZ-60L	ADC12		SPHC	6/6 nylon	—	LE-W
SZ-60T	—		—	—	ADC12	LES-AW
SZ-70L	ABS resin	Carbon steel pipe	SPHC	EPT	—	LME-W
SZ-50L	ADC12		SPHC	EPT	—	LU7
SZ-50T	—		—	—	ADC12	LHE-A
SZ-40L	ADC12	Carbon steel pipe	SPHC	EPT	—	KUS
SZ-40T	—		—	—	ADC12	
SZ-30L	—		—	SPHC	EPT	—
SZ-30T	ABS resin	—	—	—	ADC12	RH,PS
						PES

ADC12 ··· Aluminum alloy die-cast SPHC ··· Hot rolled mild (sheet) steel
EPT ··· Ethylene propylene rubber

Rubber Gasket

SZ-200A

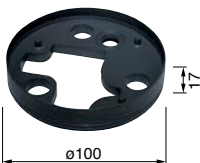

SZ-210



Model	Material	For
SZ-200A	Ethylene propylene rubber	KX, RH(B)
SZ-210		RU, RLE, PS(F), PSX, PES

Tripod stand



SZ-009

SZ-009

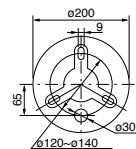

Model	For	Height
SZ-009	Pitch diameter φ120~φ140	1,285~2,285mm

Upper Bracket For LU7



(For $\phi 21.7\text{mm}$ Pole)

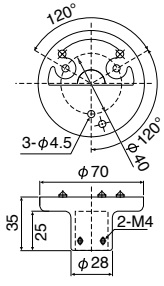

Upper Bracket For LU7

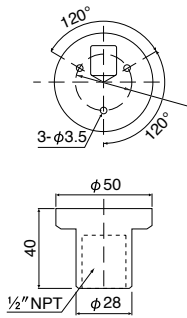
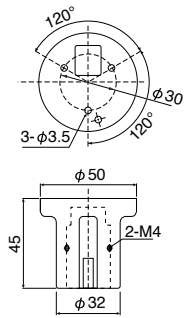
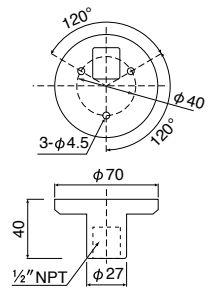

Pole

Steel Pole

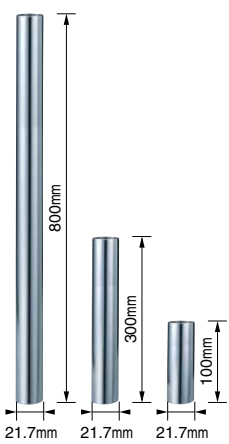

800mm : **POLE-800S21**
 300mm : **POLE-300S21**
 100mm : **POLE-100S21**

Aluminum Pole

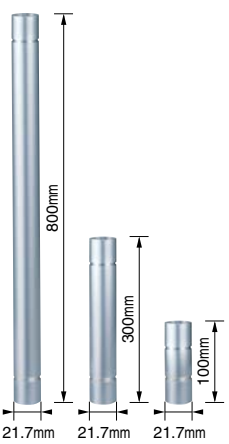

800mm : **POLE-800A21**
 300mm : **POLE-300A21**
 100mm : **POLE-100A21**

NPT Adapter

SZ-904

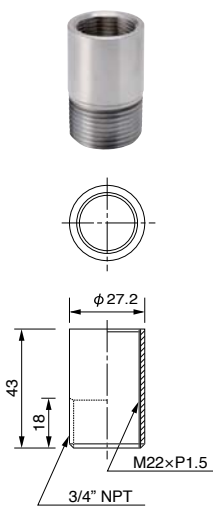

SZ-903

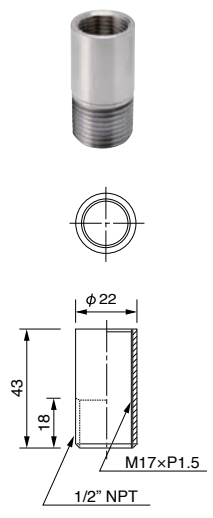

Mounting Bracket

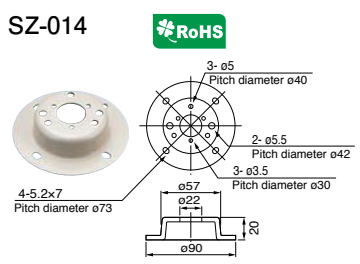
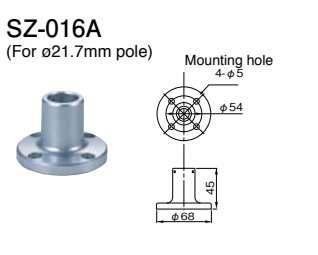
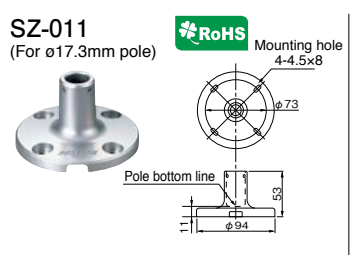
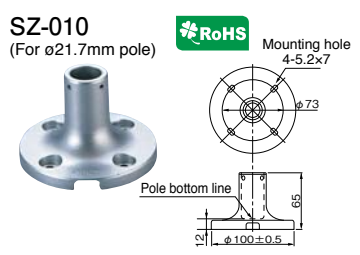

Model	Material	For
SZ-010	Aluminum alloy die-cast	STD, RUP, LME, LMS, LHE
SZ-011		LCE, LCS, LE, LES-A
SZ-016A		LU5, LU7, STD, RUP, LME, LMS, LHE
SZ-70-B	Cold rolled mild steel	LE, LES-A
SZ-014		

Optional Parts

Wall Mount Bracket

- Bracket is detachable from machinery by loosening a screw and taking off the connectors.
- Bracket can be removed or installed upside-down during transportation.
- Wiring should not be exposed.
- Silver color type: available with special order.

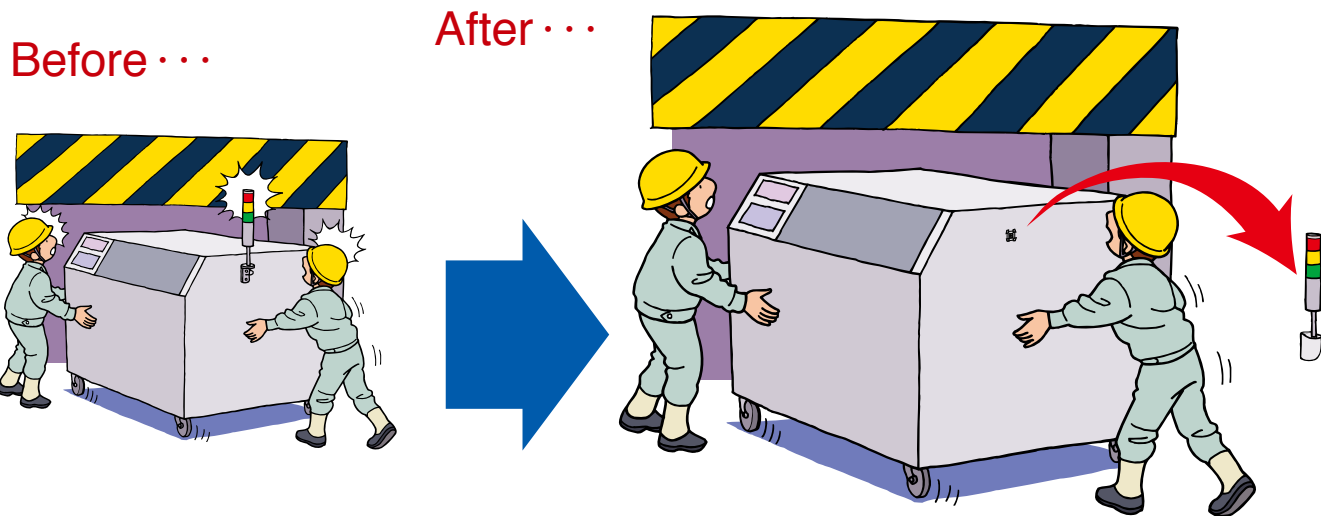

How to install



Drill a hole on the mounting surface of machinery.



Fix a mounting part and connector on the hole.



Join the connectors.



Hook the mounting bracket to the metal part by tightening with a screw.

SZ-020 (For $\phi 21.7\text{mm}$ pole)

SZ-021 (For $\phi 17.3\text{mm}$ pole)

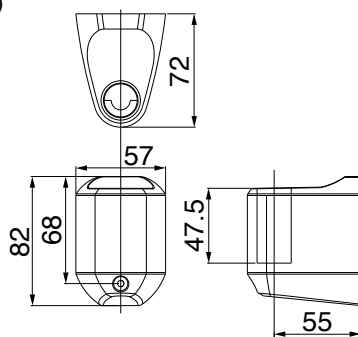

Mounting dimensions

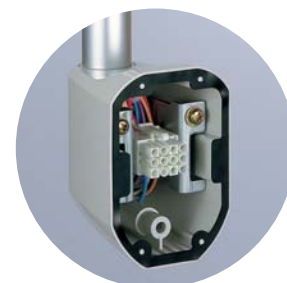
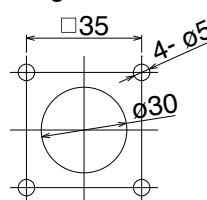

Wire connector (SZ-020-001) sold separately

Wall Mount Bracket



SZ-018

Ivory White

SZ-018U

Silver Color

SZ-018K

Black

SZ-028

SZ-017

(For $\phi 21.7$ mm Pole)

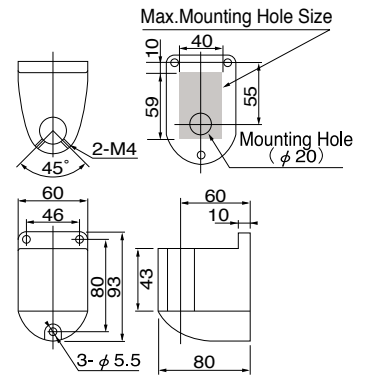
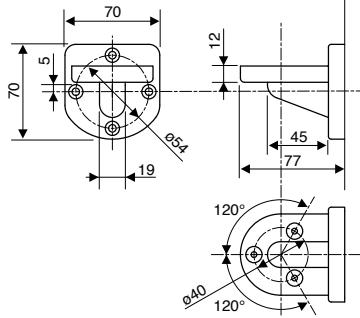
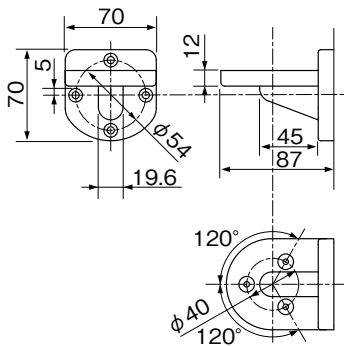

SZ-005C

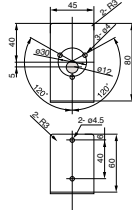

SZ-012

Pole is not included

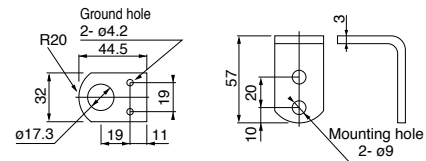

SZ-007

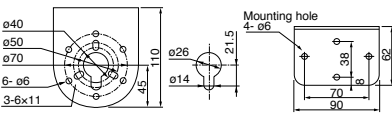

SZ-013

Pole is not included

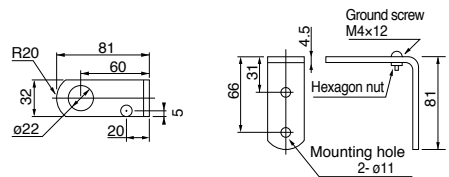

SZ-008

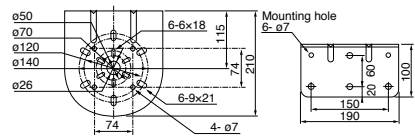

SZ-023

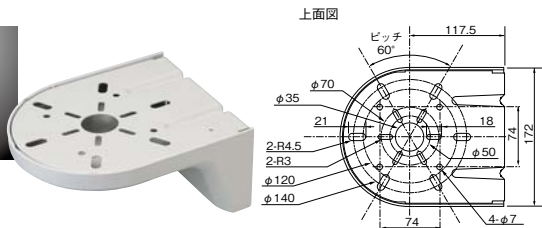

取付面寸法図

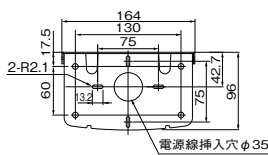





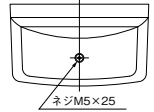

正面図



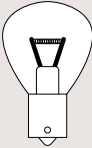

側面図

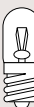

Model	Material	For
SZ-017	Aluminum alloy die-cast	LME, STD, RUP
SZ-018	PBT/ABS resin	LU7, LHE
SZ-028		LME
SZ-020	ABS resin	LU5, LU7, LME, LMS, RUP, STD
SZ-021		LC, LCS, LE, LES-A
SZ-005C	Electro-galvanized steel	LCE
SZ-007		LU7, LHE-A Pitch diameter $\phi 50$, 70
SZ-008		Pitch diameter $\phi 50, 70, 120, 140$ and $\square 74$
SZ-023		
SZ-012	Hot rolled mild steel	LCE, LCS, LE, LES
SZ-013		LME, STP, ME, MP

Replacement Bulbs

Model	Bulb No.	Wattage	Part No.
 RP35/BA15S	1	12V35W	D01203501
	2	24V35W	D02403501
 RP35/BA15D	5	48V35W	D04803502
	6	120V40W	D12004002A
 G18/BA15S	8	6V3W	D00600303
	9	12V10W	D01201003A
	10	24V10W	D02401003A
	11	48V10W	D04801003
	12	12V5W	D01200503A
 T20/E12	13	30V10W	D03001006A
	14	110V10W	D11001006A
	15	220V10W	D22001006A
	16	110V15W	D11001506A
	17	220V15W	D22001506A
 G14/BA9S	18	12V6W	D01200604
	19	24V6W	D02400604
 T10/E10	22	110V3W	D11000307
	23	110V5W	D11000507
	24	220V3W	D22000307
	26	240V5W	D24000507
	27	12V0.11A	D012/1107
	28	24V0.11A	D024/1107
 RP35/BA15D	36	120V40W	D12004024
	37	220V30W	D22003024
	38	240V30W	D24003002

Model	Bulb No.	Wattage	Part No.
 S25/BA15S	42	12V23W	D01202305
	43	24V25W	D02402505
 T10/BA15S	44	12V55W	D01205515-02
	45	24V70W	D02407015-02
 T20/E12	46	140V10W	D14001006
 G18/BA15S	54	12V15W	D01201503
	55	24V20W	D02402003